



06



**FITTINGS, FLANGES
& COUPLINGS**

The Range:

HYDRAULIC FITTINGS

Size : 1/4" to 2"

Material : 316 Stainless Steel

Page 201



INDUSTRIAL FITTINGS

Size : 1/8" to 24"

Material : 316 Stainless Steel

Page 214



COMPOSITE HOSE FITTINGS

Size : 1/8" to 1 1/4"

Material : 316 Stainless Steel & Aluminum

Page 223



PTFE FITTINGS

Size : 1/8" to 4"

Material : 316 Stainless Steel

Page 226



HYGIENIC FITTINGS

Size : 1/2" to 8"

Material : 316 Stainless Steel

Page 237



BITUMEN FITTINGS

Size : 2 1/2"

Material : Bronze & Aluminum



Page 243

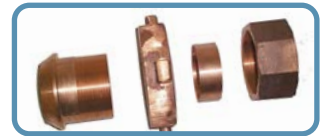

FLANGES

Size : 1/2" to 24"

Material : 316 Stainless Steel

Page 245

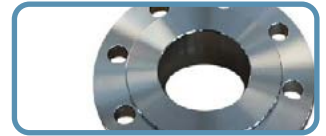

SAFETY BREAKAWAY COUPLINGS

Size : 1" to 12"

Material : 316 Stainless Steel, Aluminum & Brass

Page 251



DRY DISCONNECT COUPLINGS

Size : 1" to 6"

Material : 316 Stainless Steel, Aluminum & Brass

Page 251



EMERGENCY RELEASE COUPLINGS

Size : 1" to 12"

Material : 316 Stainless Steel, Carbon Steel & Aluminum

Page 251



FLANGE CAMLOCK COUPLINGS

Size : 2" to 24"

Material : Stainless Steel, Carbon Steel

Page 251



Hydraulic Fittings



PART NUMBER	BSPT SEATED 316 S/S HEX MALE x HYDRAULIC HOSETAIL
AF16SHH-0202-BTS	1/8" x 1/8"
AF16SHH-0203-BTS	1/8" x 3/16"
AF16SHH-0204-BTS	1/8" x 1/4"
AF16SHH-0404-BTS	1/4" x 1/4"
AF16SHH-0405-BTS	1/4" x 5/16"
AF16SHH-0406-BTS	1/4" x 3/8"
AF16SHH-0604-BTS	3/8" x 1/4"
AF16SHH-0606-BTS	3/8" x 3/8"
AF16SHH-0608-BTS	3/8" x 1/2"
AF16SHH-0804-BTS	1/2" x 1/4"
AF16SHH-0806-BTS	1/2" x 3/8"
AF16SHH-0808-BTS	1/2" x 1/2"
AF16SHH-0812-BTS	1/2" x 3/4"
AF16SHH-0816-BTS	1/2" x 1"
AF16SHH-1206-BTS	3/4" x 3/8"
AF16SHH-1208-BTS	3/4" x 1/2"
AF16SHH-1212-BTS	3/4" x 3/4"
AF16SHH-1216-BTS	3/4" x 1"
AF16SHH-1608-BTS	1" x 1/2"
AF16SHH-1612-BTS	1" x 3/4"
AF16SHH-1616-BTS	1" x 1"
AF16SHH-1620-BTS	1" x 1 1/4"
AF16SHH-2016-BTS	1 1/4" x 1"
AF16SHH-2020-BTS	1 1/4" x 1 1/4"
AF16SHH-2024-BTS	1 1/4" x 1 1/2"
AF16SHH-2420-BTS	1 1/2" x 1 1/4"
AF16SHH-2424-BTS	1 1/2" x 1 1/2"
AF16SHH-2432-BTS	1 1/2" x 2"
AF16SHH-3220-BTS	2" x 1 1/4"
AF16SHH-3224-BTS	2" x 1 1/2"
AF16SHH-3232-BTS	2" x 2"

PART NUMBER	BSPP CONE SEAT 316 S/S FEMALE SWIVEL x HYDRAULIC HOSETAIL
AF26SHH-0202-BPCS	1/8" x 1/8"
AF26SHH-0203-BPCS	1/8" x 3/16"
AF26SHH-0204-BPCS	1/8" x 1/4"
AF26SHH-0403-BPCS	1/4" x 3/16"
AF26SHH-0404-BPCS	1/4" x 1/4"
AF26SHH-0406-BPCS	1/4" x 3/8"
AF26SHH-0604-BPCS	3/8" x 1/4"
AF26SHH-0606-BPCS	3/8" x 3/8"
AF26SHH-0608-BPCS	3/8" x 1/2"
AF26SHH-0804-BPCS	1/2" x 1/4"
AF26SHH-0806-BPCS	1/2" x 3/8"
AF26SHH-0808-BPCS	1/2" x 1/2"
AF26SHH-0812-BPCS	1/2" x 3/4"
AF26SHH-0816-BPCS	1/2" x 1"
AF26SHH-1206-BPCS	3/4" x 3/8"
AF26SHH-1208-BPCS	3/4" x 1/2"
AF26SHH-1212-BPCS	3/4" x 3/4"
AF26SHH-1216-BPCS	3/4" x 1"
AF26SHH-1608-BPCS	1" x 1/2"
AF26SHH-1612-BPCS	1" x 3/4"
AF26SHH-1616-BPCS	1" x 1"
AF26SHH-1620-BPCS	1" x 1 1/4"
AF26SHH-2016-BPCS	1 1/4" x 1"
AF26SHH-2020-BPCS	1 1/4" x 1 1/4"
AF26SHH-2024-BPCS	1 1/4" x 1 1/2"
AF26SHH-2420-BPCS	1 1/2" x 1 1/4"
AF26SHH-2424-BPCS	1 1/2" x 1 1/2"
AF26SHH-2432-BPCS	1 1/2" x 2"
AF26SHH-3220-BPCS	2" x 1 1/4"
AF26SHH-3224-BPCS	2" x 1 1/2"
AF26SHH-3232-BPCS	2" x 2"

Hydraulic Fittings



PART NUMBER	BSPP SEATED 316 S/S FEMALE SWIVEL x 90° SWEPT BEND x HYDRAULIC HOSETAIL
AF26S90HH-0202-BPS	1/8" x 1/8"
AF26S90HH-0203-BPS	1/8" x 3/16"
AF26S90HH-0204-BPS	1/8" x 1/4"
AF26S90HH-0403-BPS	1/4" x 3/16"
AF26S90HH-0404-BPS	1/4" x 1/4"
AF26S90HH-0406-BPS	1/4" x 3/8"
AF26S90HH-0604-BPS	3/8" x 1/4"
AF26S90HH-0606-BPS	3/8" x 3/8"
AF26S90HH-0608-BPS	3/8" x 1/2"
AF26S90HH-0804-BPS	1/2" x 1/4"
AF26S90HH-0806-BPS	1/2" x 3/8"
AF26S90HH-0808-BPS	1/2" x 1/2"
AF26S90HH-0812-BPS	1/2" x 3/4"
AF26S90HH-0816-BPS	1/2" x 1"
AF26S90HH-1206-BPS	3/4" x 3/8"
AF26S90HH-1208-BPS	3/4" x 1/2"
AF26S90HH-1212-BPS	3/4" x 3/4"
AF26S90HH-1216-BPS	3/4" x 1"
AF26S90HH-1608-BPS	1" x 1/2"
AF26S90HH-1612-BPS	1" x 3/4"
AF26S90HH-1616-BPS	1" x 1"
AF26S90HH-1620-BPS	1" x 1 1/4"
AF26S90HH-2016-BPS	1 1/4" x 1"
AF26S90HH-2020-BPS	1 1/4" x 1 1/4"
AF26S90HH-2024-BPS	1 1/4" x 1 1/2"
AF26S90HH-2420-BPS	1 1/2" x 1 1/4"
AF26S90HH-2424-BPS	1 1/2" x 1 1/2"
AF26S90HH-2432-BPS	1 1/2" x 2"
AF26S90HH-3220-BPS	2" x 1 1/4"
AF26S90HH-3224-BPS	2" x 1 1/2"
AF26S90HH-3232-BPS	2" x 2"

PART NUMBER	BSPP SEATED 316 S/S FEMALE SWIVEL x 45° SWEPT BEND x HYDRAULIC HOSETAIL
AF26S45HH-0202-BPS	1/8" x 1/8"
AF26S45HH-0203-BPS	1/8" x 3/16"
AF26S45HH-0204-BPS	1/8" x 1/4"
AF26S45HH-0403-BPS	1/4" x 3/16"
AF26S45HH-0404-BPS	1/4" x 1/4"
AF26S45HH-0406-BPS	1/4" x 3/8"
AF26S45HH-0604-BPS	3/8" x 1/4"
AF26S45HH-0606-BPS	3/8" x 3/8"
AF26S45HH-0608-BPS	3/8" x 1/2"
AF26S45HH-0804-BPS	1/2" x 1/4"
AF26S45HH-0806-BPS	1/2" x 3/8"
AF26S45HH-0808-BPS	1/2" x 1/2"
AF26S45HH-0812-BPS	1/2" x 3/4"
AF26S45HH-0816-BPS	1/2" x 1"
AF26S45HH-1206-BPS	3/4" x 3/8"
AF26S45HH-1208-BPS	3/4" x 1/2"
AF26S45HH-1212-BPS	3/4" x 3/4"
AF26S45HH-1216-BPS	3/4" x 1"
AF26S45HH-1608-BPS	1" x 1/2"
AF26S45HH-1612-BPS	1" x 3/4"
AF26S45HH-1616-BPS	1" x 1"
AF26S45HH-1620-BPS	1" x 1 1/4"
AF26S45HH-2016-BPS	1 1/4" x 1"
AF26S45HH-2020-BPS	1 1/4" x 1 1/4"
AF26S45HH-2024-BPS	1 1/4" x 1 1/2"
AF26S45HH-2420-BPS	1 1/2" x 1 1/4"
AF26S45HH-2424-BPS	1 1/2" x 1 1/2"
AF26S45HH-2432-BPS	1 1/2" x 2"
AF26S45HH-3220-BPS	2" x 1 1/4"
AF26S45HH-3224-BPS	2" x 1 1/2"
AF26S45HH-3232-BPS	2" x 2"

Hydraulic Fittings



PART NUMBER	BSPT/P 3000 lb 316 S/S SEATED HEX MALE NIPPLE
HMN6S-0202-BT3SBP3S	1/8" x 1/8"
HMN6S-0402-BT3SBP3S	1/4" x 1/8"
HMN6S-0404-BT3SBP3S	1/4" x 1/4"
HMN6S-0602-BT3SBP3S	3/8" x 1/8"
HMN6S-0604-BT3SBP3S	3/8" x 1/4"
HMN6S-0606-BT3SBP3S	3/8" x 3/8"
HMN6S-0804-BT3SBP3S	1/2" x 1/4"
HMN6S-0806-BT3SBP3S	1/2" x 3/8"
HMN6S-0808-BT3SBP3S	1/2" x 1/2"
HMN6S-1010-BT3SBP3S	5/8" x 5/8"
HMN6S-1206-BT3SBP3S	3/4" x 3/8"
HMN6S-1208-BT3SBP3S	3/4" x 1/2"
HMN6S-1212-BT3SBP3S	3/4" x 3/4"
HMN6S-1608-BT3SBP3S	1" x 1/2"
HMN6S-1612-BT3SBP3S	1" x 3/4"
HMN6S-1616-BT3SBP3S	1" x 1"
HMN6S-2012-BT3SBP3S	1 1/4" x 3/4"
HMN6S-2016-BT3SBP3S	1 1/4" x 1"
HMN6S-2020-BT3SBP3S	1 1/4" x 1 1/4"
HMN6S-2412-BT3SBP3S	1 1/2" x 3/4"
HMN6S-2416-BT3SBP3S	1 1/2" x 1"
HMN6S-2420-BT3SBP3S	1 1/2" x 1 1/4"
HMN6S-2424-BT3SBP3S	1 1/2" x 1 1/2"
HMN6S-3212-BT3SBP3S	2" x 3/4"
HMN6S-3216-BT3SBP3S	2" x 1"
HMN6S-3220-BT3SBP3S	2" x 1 1/4"
HMN6S-3224-BT3SBP3S	2" x 1 1/2"
HMN6S-3232-BT3SBP3S	2" x 2"

PART NUMBER	BSPT x JIC 316 S/S 3000 lb SEATED HEX MALE NIPPLE
HMN6S-0207-BT3SJC	1/8" x 7/16"
HMN6S-0208-BT3SJC	1/8" x 1/2"
HMN6S-0209-BT3SJC	1/8" x 9/16"
HMN6S-0407-BT3SJC	1/4" x 7/16"
HMN6S-0408-BT3SJC	1/4" x 1/2"
HMN6S-0409-BT3SJC	1/4" x 9/16"
HMN6S-0412-BT3SJC	1/4" x 3/4"
HMN6S-0414-BT3SJC	1/4" x 7/8"
HMN6S-0607-BT3SJC	3/8" x 7/16"
HMN6S-0608-BT3SJC	3/8" x 1/2"
HMN6S-0609-BT3SJC	3/8" x 9/16"
HMN6S-0612-BT3SJC	3/8" x 3/4"
HMN6S-0614-BT3SJC	3/8" x 7/8"
HMN6S-0617-BT3SJC	3/8" x 1 1/16"
HMN6S-0807-BT3SJC	1/2" x 7/16"
HMN6S-0809-BT3SJC	1/2" x 9/16"
HMN6S-0812-BT3SJC	1/2" x 3/4"
HMN6S-0814-BT3SJC	1/2" x 7/8"
HMN6S-0817-BT3SJC	1/2" x 1 1/16"
HMN6S-0821-BT3SJC	1/2" x 1 5/16"
HMN6S-1012-BT3SJC	5/8" x 3/4"
HMN6S-1014-BT3SJC	5/8" x 7/8"
HMN6S-1209-BT3SJC	3/4" x 9/16"
HMN6S-1212-BT3SJC	3/4" x 3/4"
HMN6S-1214-BT3SJC	3/4" x 7/8"
HMN6S-1217-BT3SJC	3/4" x 1 1/16"
HMN6S-1219-BT3SJC	3/4" x 1 3/16"
HMN6S-1221-BT3SJC	3/4" x 1 5/16"
HMN6S-1614-BT3SJC	1" x 7/8"
HMN6S-1617-BT3SJC	1" x 1 1/16"
HMN6S-1619-BT3SJC	1" x 1 3/16"
HMN6S-1621-BT3SJC	1" x 1 5/16"
HMN6S-1626-BT3SJC	1" x 1 5/8"
HMN6S-2017-BT3SJC	1 1/4" x 1 1/16"
HMN6S-2021-BT3SJC	1 1/4" x 1 5/16"
HMN6S-2026-BT3SJC	1 1/4" x 1 5/8"
HMN6S-2421-BT3SJC	1 1/2" x 1 5/16"
HMN6S-2426-BT3SJC	1 1/2" x 1 5/8"
HMN6S-2430-BT3SJC	1 1/2" x 1 7/8"
HMN6S-3240-BT3SJC	2" x 2 1/2"

Hydraulic Fittings



PART NUMBER	NPT SEATED 316 S/S HEX MALE x HYDRAULIC HOSETAIL
AF16SHH-0202-NTS	1/8" x 1/8"
AF16SHH-0203-NTS	1/8" x 3/16"
AF16SHH-0204-NTS	1/8" x 1/4"
AF16SHH-0404-NTS	1/4" x 1/4"
AF16SHH-0406-NTS	1/4" x 3/8"
AF16SHH-0604-NTS	3/8" x 1/4"
AF16SHH-0606-NTS	3/8" x 3/8"
AF16SHH-0608-NTS	3/8" x 1/2"
AF16SHH-0804-NTS	1/2" x 1/4"
AF16SHH-0806-NTS	1/2" x 3/8"
AF16SHH-0808-NTS	1/2" x 1/2"
AF16SHH-0812-NTS	1/2" x 3/4"
AF16SHH-0816-NTS	1/2" x 1"
AF16SHH-1206-NTS	3/4" x 3/8"
AF16SHH-1208-NTS	3/4" x 1/2"
AF16SHH-1212-NTS	3/4" x 3/4"
AF16SHH-1216-NTS	3/4" x 1"
AF16SHH-1608-NTS	1" x 1/2"
AF16SHH-1612-NTS	1" x 3/4"
AF16SHH-1616-NTS	1" x 1"
AF16SHH-1620-NTS	1" x 1 1/4"
AF16SHH-2016-NTS	1 1/4" x 1"
AF16SHH-2020-NTS	1 1/4" x 1 1/4"
AF16SHH-2024-NTS	1 1/4" x 1 1/2"
AF16SHH-2420-NTS	1 1/2" x 1 1/4"
AF16SHH-2424-NTS	1 1/2" x 1 1/2"
AF16SHH-2432-NTS	1 1/2" x 2"
AF16SHH-3220-NTS	2" x 1 1/4"
AF16SHH-3224-NTS	2" x 1 1/2"
AF16SHH-3232-NTS	2" x 2"

PART NUMBER	NPSM CONE SEAT 316 S/S FEMALE SWIVEL x HYDRAULIC HOSETAIL
AF26SHH-0202-NMCS	1/8" x 1/8"
AF26SHH-0203-NMCS	1/8" x 3/16"
AF26SHH-0204-NMCS	1/8" x 1/4"
AF26SHH-0404-NMCS	1/4" x 1/4"
AF26SHH-0406-NMCS	1/4" x 3/8"
AF26SHH-0604-NMCS	3/8" x 1/4"
AF26SHH-0606-NMCS	3/8" x 3/8"
AF26SHH-0608-NMCS	3/8" x 1/2"
AF26SHH-0804-NMCS	1/2" x 1/4"
AF26SHH-0806-NMCS	1/2" x 3/8"
AF26SHH-0808-NMCS	1/2" x 1/2"
AF26SHH-0812-NMCS	1/2" x 3/4"
AF26SHH-0816-NMCS	1/2" x 1"
AF26SHH-1206-NMCS	3/4" x 3/8"
AF26SHH-1208-NMCS	3/4" x 1/2"
AF26SHH-1212-NMCS	3/4" x 3/4"
AF26SHH-1216-NMCS	3/4" x 1"
AF26SHH-1608-NMCS	1" x 1/2"
AF26SHH-1612-NMCS	1" x 3/4"
AF26SHH-1616-NMCS	1" x 1"
AF26SHH-1620-NMCS	1" x 1 1/4"
AF26SHH-2016-NMCS	1 1/4" x 1"
AF26SHH-2020-NMCS	1 1/4" x 1 1/4"
AF26SHH-2024-NMCS	1 1/4" x 1 1/2"
AF26SHH-2420-NMCS	1 1/2" x 1 1/4"
AF26SHH-2424-NMCS	1 1/2" x 1 1/2"
AF26SHH-2432-NMCS	1 1/2" x 2"
AF26SHH-3220-NMCS	2" x 1 1/4"
AF26SHH-3224-NMCS	2" x 1 1/2"
AF26SHH-3232-NMCS	2" x 2"

Hydraulic Fittings



PART NUMBER	NPSM CONE SEAT 316 S/S FEMALE SWIVEL x 90° SWEPT BEND x HYDRAULIC HOSETAIL
AF26S90HH-0202-NMCS	1/8" x 1/8"
AF26S90HH-0203-NMCS	1/8" x 3/16"
AF26S90HH-0204-NMCS	1/8" x 1/4"
AF26S90HH-0404-NMCS	1/4" x 1/4"
AF26S90HH-0406-NMCS	1/4" x 3/8"
AF26S90HH-0604-NMCS	3/8" x 1/4"
AF26S90HH-0606-NMCS	3/8" x 3/8"
AF26S90HH-0608-NMCS	3/8" x 1/2"
AF26S90HH-0804-NMCS	1/2" x 1/4"
AF26S90HH-0806-NMCS	1/2" x 3/8"
AF26S90HH-0808-NMCS	1/2" x 1/2"
AF26S90HH-0812-NMCS	1/2" x 3/4"
AF26S90HH-0816-NMCS	1/2" x 1"
AF26S90HH-1206-NMCS	3/4" x 3/8"
AF26S90HH-1208-NMCS	3/4" x 1/2"
AF26S90HH-1212-NMCS	3/4" x 3/4"
AF26S90HH-1216-NMCS	3/4" x 1"
AF26S90HH-1608-NMCS	1" x 1/2"
AF26S90HH-1612-NMCS	1" x 3/4"
AF26S90HH-1616-NMCS	1" x 1"
AF26S90HH-1620-NMCS	1" x 1 1/4"
AF26S90HH-2016-NMCS	1 1/4" x 1"
AF26S90HH-2020-NMCS	1 1/4" x 1 1/4"
AF26S90HH-2024-NMCS	1 1/4" x 1 1/2"
AF26S90HH-2420-NMCS	1 1/2" x 1 1/4"
AF26S90HH-2424-NMCS	1 1/2" x 1 1/2"
AF26S90HH-2432-NMCS	1 1/2" x 2"
AF26S90HH-3220-NMCS	2" x 1 1/4"
AF26S90HH-3224-NMCS	2" x 1 1/2"
AF26S90HH-3232-NMCS	2" x 2"

PART NUMBER	NPSM CONE SEAT 316 S/S FEMALE SWIVEL x 45° SWEPT BEND x HYDRAULIC HOSETAIL
AF26S45HH-0202-NMCS	1/8" x 1/8"
AF26S45HH-0203-NMCS	1/8" x 3/16"
AF26S45HH-0204-NMCS	1/8" x 1/4"
AF26S45HH-0404-NMCS	1/4" x 1/4"
AF26S45HH-0406-NMCS	1/4" x 3/8"
AF26S45HH-0604-NMCS	3/8" x 1/4"
AF26S45HH-0606-NMCS	3/8" x 3/8"
AF26S45HH-0608-NMCS	3/8" x 1/2"
AF26S45HH-0804-NMCS	1/2" x 1/4"
AF26S45HH-0806-NMCS	1/2" x 3/8"
AF26S45HH-0808-NMCS	1/2" x 1/2"
AF26S45HH-0812-NMCS	1/2" x 3/4"
AF26S45HH-0816-NMCS	1/2" x 1"
AF26S45HH-1206-NMCS	3/4" x 3/8"
AF26S45HH-1208-NMCS	3/4" x 1/2"
AF26S45HH-1212-NMCS	3/4" x 3/4"
AF26S45HH-1216-NMCS	3/4" x 1"
AF26S45HH-1608-NMCS	1" x 1/2"
AF26S45HH-1612-NMCS	1" x 3/4"
AF26S45HH-1616-NMCS	1" x 1"
AF26S45HH-1620-NMCS	1" x 1 1/4"
AF26S45HH-2016-NMCS	1 1/4" x 1"
AF26S45HH-2020-NMCS	1 1/4" x 1 1/4"
AF26S45HH-2024-NMCS	1 1/4" x 1 1/2"
AF26S45HH-2420-NMCS	1 1/2" x 1 1/4"
AF26S45HH-2424-NMCS	1 1/2" x 1 1/2"
AF26S45HH-2432-NMCS	1 1/2" x 2"
AF26S45HH-3220-NMCS	2" x 1 1/4"
AF26S45HH-3224-NMCS	2" x 1 1/2"
AF26S45HH-3232-NMCS	2" x 2"

Hydraulic Fittings



PART NUMBER	NPT 3000 lb 316 S/S SEATED HEX MALE NIPPLE
HMN6S-0202-NT3S	1/8" x 1/8"
HMN6S-0402-NT3S	1/4" x 1/8"
HMN6S-0404-NT3S	1/4" x 1/4"
HMN6S-0602-NT3S	3/8" x 1/8"
HMN6S-0604-NT3S	3/8" x 1/4"
HMN6S-0606-NT3S	3/8" x 3/8"
HMN6S-0804-NT3S	1/2" x 1/4"
HMN6S-0806-NT3S	1/2" x 3/8"
HMN6S-0808-NT3S	1/2" x 1/2"
HMN6S-1010-NT3S	5/8" x 5/8"
HMN6S-1206-NT3S	3/4" x 3/8"
HMN6S-1208-NT3S	3/4" x 1/2"
HMN6S-1212-NT3S	3/4" x 3/4"
HMN6S-1608-NT3S	1" x 1/2"
HMN6S-1612-NT3S	1" x 3/4"
HMN6S-1616-NT3S	1" x 1"
HMN6S-2012-NT3S	1 1/4" x 3/4"
HMN6S-2016-NT3S	1 1/4" x 1"
HMN6S-2020-NT3S	1 1/4" x 1 1/4"
HMN6S-2412-NT3S	1 1/2" x 3/4"
HMN6S-2416-NT3S	1 1/2" x 1"
HMN6S-2420-NT3S	1 1/2" x 1 1/4"
HMN6S-2424-NT3S	1 1/2" x 1 1/2"
HMN6S-3212-NT3S	2" x 3/4"
HMN6S-3216-NT3S	2" x 1"
HMN6S-3220-NT3S	2" x 1 1/4"
HMN6S-3224-NT3S	2" x 1 1/2"
HMN6S-3232-NT3S	2" x 2"
HMN6S-4024-NT3S	2 1/2" x 1 1/2"
HMN6S-4040-NT3S	2 1/2" x 2 1/2"

PART NUMBER	BSPT / NPT 3000 lb 316 S/S SEATED HEX MALE NIPPLE
HMN6S-0202-BT3SNT3S	1/8" x 1/8"
HMN6S-0402-BT3SNT3S	1/4" x 1/8"
HMN6S-0404-BT3SNT3S	1/4" x 1/4"
HMN6S-0602-BT3SNT3S	3/8" x 1/8"
HMN6S-0604-BT3SNT3S	3/8" x 1/4"
HMN6S-0606-BT3SNT3S	3/8" x 3/8"
HMN6S-0804-BT3SNT3S	1/2" x 1/4"
HMN6S-0806-BT3SNT3S	1/2" x 3/8"
HMN6S-0808-BT3SNT3S	1/2" x 1/2"
HMN6S-1010-BT3SNT3S	5/8" x 5/8"
HMN6S-1206-BT3SNT3S	3/4" x 3/8"
HMN6S-1208-BT3SNT3S	3/4" x 1/2"
HMN6S-1212-BT3SNT3S	3/4" x 3/4"
HMN6S-1608-BT3SNT3S	1" x 1/2"
HMN6S-1612-BT3SNT3S	1" x 3/4"
HMN6S-1616-BT3SNT3S	1" x 1"
HMN6S-2012-BT3SNT3S	1 1/4" x 3/4"
HMN6S-2016-BT3SNT3S	1 1/4" x 1"
HMN6S-2020-BT3SNT3S	1 1/4" x 1 1/4"
HMN6S-2412-BT3SNT3S	1 1/2" x 3/4"
HMN6S-2416-BT3SNT3S	1 1/2" x 1"
HMN6S-2420-BT3SNT3S	1 1/2" x 1 1/4"
HMN6S-2424-BT3SNT3S	1 1/2" x 1 1/2"
HMN6S-3212-BT3SNT3S	2" x 3/4"
HMN6S-3216-BT3SNT3S	2" x 1"
HMN6S-3220-BT3SNT3S	2" x 1 1/4"
HMN6S-3224-BT3SNT3S	2" x 1 1/2"
HMN6S-3232-BT3SNT3S	2" x 2"
HMN6S-4024-BT3SNT3S	2 1/2" x 1 1/2"
HMN6S-4040-BT3SNT3S	2 1/2" x 2 1/2"

Hydraulic Fittings



PART NUMBER	NPT / JIC 3000 lb 316 S/S SEATED HEX MALE NIPPLE
HMN6S-0207-NT3SJC	1/8" x 7/16"
HMN6S-0208-NT3SJC	1/8" x 1/2"
HMN6S-0209-NT3SJC	1/8" x 9/16"
HMN6S-0407-NT3SJC	1/4" x 7/16"
HMN6S-0408-NT3SJC	1/4" x 1/2"
HMN6S-0409-NT3SJC	1/4" x 9/16"
HMN6S-0412-NT3SJC	1/4" x 3/4"
HMN6S-0414-NT3SJC	1/4" x 7/8"
HMN6S-0607-NT3SJC	3/8" x 7/16"
HMN6S-0608-NT3SJC	3/8" x 1/2"
HMN6S-0609-NT3SJC	3/8" x 9/16"
HMN6S-0612-NT3SJC	3/8" x 3/4"
HMN6S-0614-NT3SJC	3/8" x 7/8"
HMN6S-0617-NT3SJC	3/8" x 1 1/16"
HMN6S-0807-NT3SJC	1/2" x 7/16"
HMN6S-0809-NT3SJC	1/2" x 9/16"
HMN6S-0812-NT3SJC	1/2" x 3/4"
HMN6S-0814-NT3SJC	1/2" x 7/8"
HMN6S-0817-NT3SJC	1/2" x 1 1/16"
HMN6S-0821-NT3SJC	1/2" x 1 5/16"
HMN6S-1012-NT3SJC	5/8" x 3/4"
HMN6S-1014-NT3SJC	5/8" x 7/8"
HMN6S-1209-NT3SJC	3/4" x 9/16"
HMN6S-1212-NT3SJC	3/4" x 3/4"
HMN6S-1214-NT3SJC	3/4" x 7/8"
HMN6S-1217-NT3SJC	3/4" x 1 1/16"
HMN6S-1219-NT3SJC	3/4" x 1 3/16"
HMN6S-1221-NT3SJC	3/4" x 1 5/16"
HMN6S-1614-NT3SJC	1" x 7/8"
HMN6S-1617-NT3SJC	1" x 1 1/16"
HMN6S-1619-NT3SJC	1" x 1 3/16"
HMN6S-1621-NT3SJC	1" x 1 5/16"
HMN6S-1626-NT3SJC	1" x 1 5/8"
HMN6S-2017-NT3SJC	1 1/4" x 1 1/16"
HMN6S-2021-NT3SJC	1 1/4" x 1 5/16"
HMN6S-2026-NT3SJC	1 1/4" x 1 5/8"
HMN6S-2421-NT3SJC	1 1/2" x 1 5/16"
HMN6S-2426-NT3SJC	1 1/2" x 1 5/8"
HMN6S-2430-NT3SJC	1 1/2" x 1 7/8"
HMN6S-3240-NT3SJC	2" x 2 1/2"

PART NUMBER	JIC 316 S/S 3000 lb HEX MALE NIPPLE
HMN6S-0707-JC	7/16" x 7/16"
HMN6S-0709-JC	7/16" x 9/16"
HMN6S-0712-JC	7/16" x 3/4"
HMN6S-0714-JC	7/16" x 7/8"
HMN6S-0717-JC	7/16" x 1 1/16"
HMN6S-0808-JC	1/2" x 1/2"
HMN6S-0907-JC	9/16" x 7/16"
HMN6S-0909-JC	9/16" x 9/16"
HMN6S-0912-JC	9/16" x 3/4"
HMN6S-0914-JC	9/16" x 7/8"
HMN6S-0917-JC	9/16" x 1 1/16"
HMN6S-0921-JC	9/16" x 1 5/16"
HMN6S-1209-JC	3/4" x 9/16"
HMN6S-1212-JC	3/4" x 3/4"
HMN6S-1214-JC	3/4" x 7/8"
HMN6S-1217-JC	3/4" x 1 1/16"
HMN6S-1221-JC	3/4" x 1 5/16"
HMN6S-1412-JC	7/8" x 3/4"
HMN6S-1414-JC	7/8" x 7/8"
HMN6S-1417-JC	7/8" x 1 1/16"
HMN6S-1707-JC	1 1/16" x 7/16"
HMN6S-1708-JC	1 1/16" x 1/2"
HMN6S-1709-JC	1 1/16" x 9/16"
HMN6S-1712-JC	1 1/16" x 3/4"
HMN6S-1714-JC	1 1/16" x 7/8"
HMN6S-1717-JC	1 1/16" x 1 1/16"
HMN6S-1721-JC	1 1/16" x 1 5/16"
HMN6S-1919-JC	1 3/16" x 1 3/16"
HMN6S-2112-JC	1 5/16" x 3/4"
HMN6S-2114-JC	1 5/16" x 7/8"
HMN6S-2117-JC	1 5/16" x 1 1/16"
HMN6S-2121-JC	1 5/16" x 1 5/16"
HMN6S-2126-JC	1 5/16" x 1 5/8"
HMN6S-2621-JC	1 5/8" x 1 5/16"
HMN6S-2626-JC	1 5/8" x 1 5/8"
HMN6S-3030-JC	1 7/8" x 1 7/8"
HMN6S-4040-JC	2 1/2" x 2 1/2"

Hydraulic Fittings



PART NUMBER	JIC 316 S/S HEX MALE x HYDRAULIC HOSETAIL
AF16SHH-0702-JC	7/16" x 1/8"
AF16SHH-0703-JC	7/16" x 3/16"
AF16SHH-0704-JC	7/16" x 1/4"
AF16SHH-0706-JC	7/16" x 3/8"
AF16SHH-0904-JC	9/16" x 1/4"
AF16SHH-0906-JC	9/16" x 3/8"
AF16SHH-0908-JC	9/16" x 1/2"
AF16SHH-1204-JC	3/4" x 1/4"
AF16SHH-1206-JC	3/4" x 3/8"
AF16SHH-1208-JC	3/4" x 1/2"
AF16SHH-1210-JC	3/4" x 5/8"
AF16SHH-1406-JC	7/8" x 3/8"
AF16SHH-1408-JC	7/8" x 1/2"
AF16SHH-1410-JC	7/8" x 5/8"
AF16SHH-1412-JC	7/8" x 3/4"
AF16SHH-1710-JC	1 1/16" x 5/8"
AF16SHH-1712-JC	1 1/16" x 3/4"
AF16SHH-1716-JC	1 1/16" x 1"
AF16SHH-1912-JC	1 3/16" x 3/4"
AF16SHH-1916-JC	1 3/16" x 1"
AF16SHH-2112-JC	1 5/16" x 3/4"
AF16SHH-2116-JC	1 5/16" x 1"
AF16SHH-2120-JC	1 5/16" x 1 1/4"
AF16SHH-2616-JC	1 5/8" x 1"
AF16SHH-2620-JC	1 5/8" x 1 1/4"
AF16SHH-3020-JC	1 7/8" x 1 1/4"
AF16SHH-3024-JC	1 7/8" x 1 1/2"
AF16SHH-3032-JC	1 7/8" x 2"
AF16SHH-4024-JC	2 1/2" x 1 1/2"
AF16SHH-4032-JC	2 1/2" x 2"

PART NUMBER	JIC 316 S/S FEMALE SWIVEL x HYDRAULIC HOSETAIL
AF26SHH-0702-JC	7/16" x 1/8"
AF26SHH-0703-JC	7/16" x 3/16"
AF26SHH-0704-JC	7/16" x 1/4"
AF26SHH-0706-JC	7/16" x 3/8"
AF26SHH-0904-JC	9/16" x 1/4"
AF26SHH-0906-JC	9/16" x 3/8"
AF26SHH-0908-JC	9/16" x 1/2"
AF26SHH-1204-JC	3/4" x 1/4"
AF26SHH-1206-JC	3/4" x 3/8"
AF26SHH-1208-JC	3/4" x 1/2"
AF26SHH-1210-JC	3/4" x 5/8"
AF26SHH-1406-JC	7/8" x 3/8"
AF26SHH-1408-JC	7/8" x 1/2"
AF26SHH-1410-JC	7/8" x 5/8"
AF26SHH-1412-JC	7/8" x 3/4"
AF26SHH-1710-JC	1 1/16" x 5/8"
AF26SHH-1712-JC	1 1/16" x 3/4"
AF26SHH-1716-JC	1 1/16" x 1"
AF26SHH-1912-JC	1 3/16" x 3/4"
AF26SHH-1916-JC	1 3/16" x 1"
AF26SHH-2112-JC	1 5/16" x 3/4"
AF26SHH-2116-JC	1 5/16" x 1"
AF26SHH-2120-JC	1 5/16" x 1 1/4"
AF26SHH-2616-JC	1 5/8" x 1"
AF26SHH-2620-JC	1 5/8" x 1 1/4"
AF26SHH-3020-JC	1 7/8" x 1 1/4"
AF26SHH-3024-JC	1 7/8" x 1 1/2"
AF26SHH-3032-JC	1 7/8" x 2"
AF26SHH-4024-JC	2 1/2" x 1 1/2"
AF26SHH-4032-JC	2 1/2" x 2"

Hydraulic Fittings



PART NUMBER	JIC 316 S/S FEMALE SWIVEL x 90° SWEPT BEND x HYDRAULIC HOSETAIL
AF26S90HH-0702-JC	7/16" x 1/8"
AF26S90HH-0703-JC	7/16" x 3/16"
AF26S90HH-0704-JC	7/16" x 1/4"
AF26S90HH-0706-JC	7/16" x 3/8"
AF26S90HH-0904-JC	9/16" x 1/4"
AF26S90HH-0906-JC	9/16" x 3/8"
AF26S90HH-0908-JC	9/16" x 1/2"
AF26S90HH-1204-JC	3/4" x 1/4"
AF26S90HH-1206-JC	3/4" x 3/8"
AF26S90HH-1208-JC	3/4" x 1/2"
AF26S90HH-1210-JC	3/4" x 5/8"
AF26S90HH-1406-JC	7/8" x 3/8"
AF26S90HH-1408-JC	7/8" x 1/2"
AF26S90HH-1410-JC	7/8" x 5/8"
AF26S90HH-1412-JC	7/8" x 3/4"
AF26S90HH-1710-JC	1 1/16" x 5/8"
AF26S90HH-1712-JC	1 1/16" x 3/4"
AF26S90HH-1716-JC	1 1/16" x 1"
AF26S90HH-1912-JC	1 3/16" x 3/4"
AF26S90HH-1916-JC	1 3/16" x 1"
AF26S90HH-2112-JC	1 5/16" x 3/4"
AF26S90HH-2116-JC	1 5/16" x 1"
AF26S90HH-2120-JC	1 5/16" x 1 1/4"
AF26S90HH-2616-JC	1 5/8" x 1"
AF26S90HH-2620-JC	1 5/8" x 1 1/4"
AF26S90HH-3020-JC	1 7/8" x 1 1/4"
AF26S90HH-3024-JC	1 7/8" x 1 1/2"
AF26S90HH-3032-JC	1 7/8" x 2"
AF26S90HH-4024-JC	2 1/2" x 1 1/2"
AF26S90HH-4032-JC	2 1/2" x 2"

PART NUMBER	JIC 316 S/S FEMALE SWIVEL x 45° SWEPT BEND x HYDRAULIC HOSETAIL
AF26S45HH-0702-JC	7/16" x 1/8"
AF26S45HH-0703-JC	7/16" x 3/16"
AF26S45HH-0704-JC	7/16" x 1/4"
AF26S45HH-0706-JC	7/16" x 3/8"
AF26S45HH-0904-JC	9/16" x 1/4"
AF26S45HH-0906-JC	9/16" x 3/8"
AF26S45HH-0908-JC	9/16" x 1/2"
AF26S45HH-1204-JC	3/4" x 1/4"
AF26S45HH-1206-JC	3/4" x 3/8"
AF26S45HH-1208-JC	3/4" x 1/2"
AF26S45HH-1210-JC	3/4" x 5/8"
AF26S45HH-1406-JC	7/8" x 3/8"
AF26S45HH-1408-JC	7/8" x 1/2"
AF26S45HH-1410-JC	7/8" x 5/8"
AF26S45HH-1412-JC	7/8" x 3/4"
AF26S45HH-1710-JC	1 1/16" x 5/8"
AF26S45HH-1712-JC	1 1/16" x 3/4"
AF26S45HH-1716-JC	1 1/16" x 1"
AF26S45HH-1912-JC	1 3/16" x 3/4"
AF26S45HH-1916-JC	1 3/16" x 1"
AF26S45HH-2112-JC	1 5/16" x 3/4"
AF26S45HH-2116-JC	1 5/16" x 1"
AF26S45HH-2120-JC	1 5/16" x 1 1/4"
AF26S45HH-2616-JC	1 5/8" x 1"
AF26S45HH-2620-JC	1 5/8" x 1 1/4"
AF26S45HH-3020-JC	1 7/8" x 1 1/4"
AF26S45HH-3024-JC	1 7/8" x 1 1/2"
AF26S45HH-3032-JC	1 7/8" x 2"
AF26S45HH-4024-JC	2 1/2" x 1 1/2"
AF26S45HH-4032-JC	2 1/2" x 2"

Hydraulic Fittings



PART NUMBER	METRIC LIGHT DKL MALE 316 S/S x HYDRAULIC HOSETAIL	TUBE SIZE (mm)
AF16SHH-1215-04-DKL	M12 x 1.5 x 1/4"	6 L
AF16SHH-1415-04-DKL	M14 x 1.5 x 1/4"	8 L
AF16SHH-1615-04-DKL	M16 x 1.5 x 1/4"	10 L
AF16SHH-1615-06-DKL	M16 x 1.5 x 3/8"	10 L
AF16SHH-1815-06-DKL	M18 x 1.5 x 3/8"	12 L
AF16SHH-2215-06-DKL	M22 x 1.5 x 3/8"	15 L
AF16SHH-2215-08-DKL	M22 x 1.5 x 1/2"	15 L
AF16SHH-2615-08-DKL	M26 x 1.5 x 1/2"	18 L
AF16SHH-3015-10-DKL	M30 x 1.5 x 5/8"	22 L
AF16SHH-3020-12-DKL	M30 x 2.0 x 3/4"	22 L
AF16SHH-3620-12-DKL	M36 x 2.0 x 3/4"	28 L
AF16SHH-3620-16-DKL	M36 x 2.0 x 1"	28 L
AF16SHH-4520-20-DKL	M45 x 2.0 x 1 1/4"	35 L
AF16SHH-5220-24-DKL	M52 x 2.0 x 1 1/2"	42 L



PART NUMBER	METRIC LIGHT DKL FEMALE 316 S/S x HYDRAULIC HOSETAIL	TUBE SIZE (mm)
AF26SHH-1215-04-DKL	M12 x 1.5 x 1/4"	6 L
AF26SHH-1415-04-DKL	M14 x 1.5 x 1/4"	8 L
AF26SHH-1615-04-DKL	M16 x 1.5 x 1/4"	10 L
AF26SHH-1815-04-DKL	M18 x 1.5 x 1/4"	12 L
AF26SHH-1615-05-DKL	M16 x 1.5 x 5/16"	10 L
AF26SHH-1815-05-DKL	M18 x 1.5 x 5/16"	12 L
AF26SHH-1615-06-DKL	M16 x 1.5 x 3/8"	10 L
AF26SHH-1815-06-DKL	M18 x 1.5 x 3/8"	12 L
AF26SHH-2215-06-DKL	M22 x 1.5 x 3/8"	15 L
AF26SHH-2215-08-DKL	M22 x 1.5 x 1/2"	15 L
AF26SHH-2615-08-DKL	M26 x 1.5 x 1/2"	18 L
AF26SHH-2615-10-DKL	M26 x 1.5 x 5/8"	18 L
AF26SHH-2615-12-DKL	M26 x 1.5 x 3/4"	18 L
AF26SHH-3020-12-DKL	M30 x 2.0 x 3/4"	22 L
AF26SHH-3620-12-DKL	M36 x 2.0 x 3/4"	28 L
AF26SHH-3620-16-DKL	M36 x 2.0 x 1"	28 L
AF26SHH-4520-20-DKL	M45 x 2.0 x 1 1/4"	35 L
AF26SHH-5220-24-DKL	M52 x 2.0 x 1 1/2"	42 L



PART NUMBER	METRIC LIGHT DKL 316 S/S COMPRESSION FITTINGS	TUBE SIZE (mm)
COMHM6S-1215-DKL	M12 x 1.5	6 L
COMHM6S-1415-DKL	M14 x 1.5	8 L
COMHM6S-1615-DKL	M16 x 1.5	10 L
COMHM6S-1815-DKL	M18 x 1.5	12 L
COMHM6S-2215-DKL	M22 x 1.5	15 L
COMHM6S-2615-DKL	M26 x 1.5	18 L
COMHM6S-3615-DKL	M36 x 1.5	28 L

Hydraulic Fittings



PART NUMBER	METRIC HEAVY DKS MALE 316 S/S x HYDRAULIC HOSETAIL	TUBE SIZE (mm)
AF16SHH-1615-04-DKS	M16 x 1.5 x 1/4"	8 S
AF16SHH-1815-04-DKS	M18 x 1.5 x 1/4"	10 S
AF16SHH-2015-05-DKS	M20 x 1.5 x 5/16"	12 S
AF16SHH-2015-06-DKS	M20 x 1.5 x 3/8"	12 S
AF16SHH-2215-06-DKS	M22 x 1.5 x 3/8"	14 S
AF16SHH-2415-08-DKS	M24 x 1.5 x 1/2"	16 S
AF16SHH-3020-10-DKS	M30 x 2.0 x 5/8"	20 S
AF16SHH-3020-12-DKS	M30 x 2.0 x 3/4"	20 S
AF16SHH-3620-12-DKS	M36 x 2.0 x 3/4"	25 S
AF16SHH-3620-16-DKS	M36 x 2.0 x 1"	30 S
AF16SHH-5220-20-DKS	M52 x 2.0 x 1 1/4"	38 S

PART NUMBER	METRIC HEAVY DKS FEMALE 316 S/S x HYDRAULIC HOSETAIL	TUBE SIZE (mm)
AF26SHH-1615-04-DKS	M16 x 1.5 x 1/4"	8 S
AF26SHH-1815-04-DKS	M18 x 1.5 x 1/4"	10 S
AF26SHH-2015-05-DKS	M20 x 1.5 x 5/16"	12 S
AF26SHH-2015-06-DKS	M20 x 1.5 x 3/8"	12 S
AF26SHH-2215-06-DKS	M22 x 1.5 x 3/8"	14 S
AF26SHH-2415-08-DKS	M24 x 1.5 x 1/2"	16 S
AF26SHH-3020-10-DKS	M30 x 2.0 x 5/8"	20 S
AF26SHH-3020-12-DKS	M36 x 2.0 x 3/4"	25 S
AF26SHH-4220-16-DKS	M42 x 2.0 x 1"	30 S
AF26SHH-5220-20-DKS	M52 x 2.0 x 1 1/4"	38 S



PART NUMBER	METRIC HEAVY DKS 316 S/S COMPRESSION FITTINGS	TUBE SIZE (mm)
COMHM6S-1615-DKS	M16 x 1.5	8 S
COMHM6S-1815-DKS	M18 x 1.5	10 S
COMHM6S-2015-DKS	M20 x 1.5	12 S
COMHM6S-2415-DKS	M24 x 1.5	16 S
COMHM6S-3620-DKS	M36 x 2.0	25 S
COMHM6S-4220-DKS	M42 x 2.0	30 S

Hydraulic Fittings



PART NUMBER	1 & 2 WIRE NON SKIVE S/S FERRULE
R1/26S-03	3/16"
R1/26S-04	1/4"
R1/26S-05	5/16"
R1/26S-06	3/8"
R1/26S-08	1/2"
R1/26S-10	5/8"
R1/26S-12	3/4"
R1/26S-16	1"
R1/26S-20	1 1/4"
R1/26S-24	1 1/2"
R1/26S-32	2"



PART NUMBER	R7 & R8 316 S/S FERRULE
R7/86S-02	1/8"
R7/86S-03	3/16"
R7/86S-04	1/4"
R7/86S-05	5/16"
R7/86S-06	3/8"
R7/86S-08	1/2"
R7/86S-10	5/8"
R7/86S-12	3/4"
R7/86S-16	1"



PART NUMBER	PTFE UNIVERSAL 316 S/S FERRULE
PUF6S-02	1/8"
PUF6S-03	3/16"
PUF6S-04	1/4"
PUF6S-05	5/16"
PUF6S-06	3/8"
PUF6S-08	1/2"
PUF6S-10	5/8"
PUF6S-12	3/4"
PUF6S-16	1"
PUF6S-20	1-1/4"
PUF6S-24	1-1/2"
PUF6S-32	2"
PUF6S-40	2-1/2"
PUF6S-48	3"
PUF6S-64	4"



PART NUMBER	PTFE SAE 100 R14 316 S/S FERRULE
R146S-02	1/8"
R146S-03	3/16"
R146S-04	1/4"
R146S-05	5/16"
R146S-06	3/8"
R146S-08	1/2"
R146S-10	5/8"
R146S-12	3/4"
R146S-16	1"

Hydraulic Fittings



PART NUMBER	STANDPIPE 316 S/S x HYDRAULIC HOSETAIL (IMPERIAL)
AF106SHH-I-0202	1/8" x 1/8"
AF106SHH-I-0203	1/8" x 3/16"
AF106SHH-I-0204	1/8" x 1/4"
AF106SHH-I-0303	3/16" x 3/16"
AF106SHH-I-0304	3/16" x 1/4"
AF106SHH-I-0402	1/4" x 1/8"
AF106SHH-I-0403	1/4" x 3/16"
AF106SHH-I-0404	1/4" x 1/4"
AF106SHH-I-0406	1/4" x 3/8"
AF106SHH-I-0408	1/4" x 1/2"
AF106SHH-I-0604	3/8" x 1/4"
AF106SHH-I-0606	3/8" x 3/8"
AF106SHH-I-0608	3/8" x 1/2"
AF106SHH-I-0806	1/2" x 3/8"
AF106SHH-I-0808	1/2" x 1/2"
AF106SHH-I-0810	1/2" x 5/8"
AF106SHH-I-0812	1/2" x 3/4"
AF106SHH-I-1008	5/8" x 1/2"
AF106SHH-I-1010	5/8" x 5/8"
AF106SHH-I-1012	5/8" x 3/4"
AF106SHH-I-1208	1/2" x 3/4"
AF106SHH-I-1210	3/4" x 5/8"
AF106SHH-I-1212	3/4" x 3/4"
AF106SHH-I-1216	3/4" x 1"
AF106SHH-I-1612	1" x 3/4"
AF106SHH-I-1616	1" x 1"
AF106SHH-I-2020	1 1/4" x 1 1/4"
AF106SHH-I-2424	1 1/2" x 1 1/2"
AF106SHH-I-3232	2" x 2"

PART NUMBER	STANDPIPE 316 S/S x HYDRAULIC HOSETAIL (METRIC)
AF106SHH-M-0202	3mm x 1/8"
AF106SHH-M-0303	4mm x 3/16"
AF106SHH-M-0404	6mm x 1/4"
AF106SHH-M-0606	10mm x 3/8"
AF106SHH-M-0808	12mm x 1/2"
AF106SHH-M-1010	15mm x 5/8"
AF106SHH-M-1212	20mm x 3/4"
AF106SHH-M-1616	25mm x 1"
AF106SHH-M-2020	32mm x 1 1/4"
AF106SHH-M-2424	38mm x 1 1/2"
AF106SHH-M-3232	50mm x 2"



PART NUMBER	HYDRAULIC 316 S/S LIFESAVER TAIL
LT6SHH-02	1/8"
LT6SHH-03	3/16"
LT6SHH-04	1/4"
LT6SHH-05	5/16"
LT6SHH-06	3/8"
LT6SHH-08	1/2"
LT6SHH-10	5/8"
LT6SHH-12	3/4"
LT6SHH-16	1"
LT6SHH-20	1 1/4"
LT6SHH-24	1 1/2"
LT6SHH-32	2"
LT6SHH-40	2 1/2"
LT6SHH-48	3"
LT6SHH-64	4"

Industrial Fittings



PART NUMBER		ANSI 150 lb ASME B16.5 FIXED FLANGE x INDUSTRIAL HOSETAIL
316 S/S	MILD STEEL	
AF36SIH-25-A1	AF3MSIH-25-A1	1"
AF36SIH-32-A1	AF3MSIH-32-A1	1 1/4"
AF36SIH-40-A1	AF3MSIH-40-A1	1 1/2"
AF36SIH-50-A1	AF3MSIH-50-A1	2"
AF36SIH-65-A1	AF3MSIH-65-A1	2 1/2"
AF36SIH-80-A1	AF3MSIH-80-A1	3"
AF36SIH-100-A1	AF3MSIH-100-A1	4"
AF36SIH-125-A1	AF3MSIH-125-A1	5"
AF36SIH-150-A1	AF3MSIH-150-A1	6"
AF36SIH-200-A1	AF3MSIH-200-A1	8"
AF36SIH-250-A1	AF3MSIH-250-A1	10"
AF36SIH-300-A1	AF3MSIH-300-A1	12"
AF36SIH-350-A1	AF3MSIH-350-A1	14"

* Also available in Floating Flanges



PART NUMBER		TAB 'E' AS2129 FIXED FLANGE x INDUSTRIAL HOSETAIL
316 S/S	MILD STEEL	
AF36SIH-25-E	AF3MSIH-25-E	1"
AF36SIH-32-E	AF3MSIH-32-E	1 1/4"
AF36SIH-40-E	AF3MSIH-40-E	1 1/2"
AF36SIH-50-E	AF3MSIH-50-E	2"
AF36SIH-65-E	AF3MSIH-65-E	2 1/2"
AF36SIH-80-E	AF3MSIH-80-E	3"
AF36SIH-100-E	AF3MSIH-100-E	4"
AF36SIH-125-E	AF3MSIH-125-E	5"
AF36SIH-150-E	AF3MSIH-150-E	6"
AF36SIH-200-E	AF3MSIH-200-E	8"
AF36SIH-250-E	AF3MSIH-250-E	10"
AF36SIH-300-E	AF3MSIH-300-E	12"
AF36SIH-350-E	AF3MSIH-350-E	14"

* Also available in Floating Flanges



PART NUMBER		EN 1092-1 DIN 16 FIXED FLANGE x INDUSTRIAL HOSETAIL
316 S/S	MILD STEEL	
AF36SIH-25-D16	AF3MSIH-25-D16	1"
AF36SIH-32-D16	AF3MSIH-32-D16	1 1/4"
AF36SIH-40-D16	AF3MSIH-40-D16	1 1/2"
AF36SIH-50-D16	AF3MSIH-50-D16	2"
AF36SIH-65-D16	AF3MSIH-65-D16	2 1/2"
AF36SIH-80-D16	AF3MSIH-80-D16	3"
AF36SIH-100-D16	AF3MSIH-100-D16	4"
AF36SIH-125-D16	AF3MSIH-125-D16	5"
AF36SIH-150-D16	AF3MSIH-150-D16	6"
AF36SIH-200-D16	AF3MSIH-200-D16	8"
AF36SIH-250-D16	AF3MSIH-250-D16	10"
AF36SIH-300-D16	AF3MSIH-300-D16	12"
AF36SIH-350-D16	AF3MSIH-350-D16	14"

**Specialised Encapsulated Fittings
Available on request.**



Industrial Fittings



PART NUMBER	BSPT 150lb 316 S/S HEX MALE WELD ON
AF16SW-02-BT	1/8"
AF16SW-04-BT	1/4"
AF16SW-06-BT	3/8"
AF16SW-08-BT	1/2"
AF16SW-10-BT	5/8"
AF16SW-12-BT	3/4"
AF16SW-16-BT	1"
AF16SW-20-BT	1 1/4"
AF16SW-24-BT	1 1/2"
AF16SW-32-BT	2"
AF16SW-40-BT	2 1/2"
AF16SW-48-BT	3"
AF16SW-64-BT	4"

PART NUMBER	BSPP CONE SEAT 316 S/S FEMALE SWIVEL WELD ON
AF26SW-02-BPCS	1/8"
AF26SW-04-BPCS	1/4"
AF26SW-06-BPCS	3/8"
AF26SW-08-BPCS	1/2"
AF26SW-10-BPCS	5/8"
AF26SW-12-BPCS	3/4"
AF26SW-16-BPCS	1"
AF26SW-20-BPCS	1 1/4"
AF26SW-24-BPCS	1 1/2"
AF26SW-32-BPCS	2"
AF26SW-40-BPCS	2 1/2"
AF26SW-48-BPCS	3"
AF26SW-64-BPCS	4"



PART NUMBER	BSPP 150 lb 316 S/S 3 PIECE FEMALE/FEMALE BARREL UNION
AF126S-02-BP1	1/8"
AF126S-04-BP1	1/4"
AF126S-06-BP1	3/8"
AF126S-08-BP1	1/2"
AF126S-12-BP1	3/4"
AF126S-16-BP1	1"
AF126S-20-BP1	1 1/4"
AF126S-24-BP1	1 1/2"
AF126S-32-BP1	2"
AF126S-40-BP1	2 1/2"
AF126S-48-BP1	3"
AF126S-64-BP1	4"

PART NUMBER	BSPP X BSPT 150 lb 316 S/S 3 PIECE FEMALE/MALE BARREL UNION
AF116S-04-BP1	1/4"
AF116S-06-BP1	3/8"
AF116S-08-BP1	1/2"
AF116S-12-BP1	3/4"
AF116S-16-BP1	1"
AF116S-20-BP1	1 1/4"
AF116S-24-BP1	1 1/2"
AF116S-32-BP1	2"
AF116S-40-BP1	2 1/2"
AF116S-48-BP1	3"
AF116S-64-BP1	4"

Industrial Fittings



PART NUMBER	NPT 316 S/S 150lb HEX MALE WELD ON
AF16SW-02-NT1	1/8"
AF16SW-04-NT1	1/4"
AF16SW-06-NT1	3/8"
AF16SW-08-NT1	1/2"
AF16SW-10-NT1	5/8"
AF16SW-12-NT1	3/4"
AF16SW-16-NT1	1"
AF16SW-20-NT1	1 1/4"
AF16SW-24-NT1	1 1/2"
AF16SW-32-NT1	2"
AF16SW-40-NT1	2 1/2"
AF16SW-48-NT1	3"
AF16SW-64-NT1	4"



PART NUMBER	NPSM CONE SEAT 316 S/S FEMALE SWIVEL WELD ON
AF26SW-02-NMCS	1/8"
AF26SW-04-NMCS	1/4"
AF26SW-06-NMCS	3/8"
AF26SW-08-NMCS	1/2"
AF26SW-10-NMCS	5/8"
AF26SW-12-NMCS	3/4"
AF26SW-16-NMCS	1"
AF26SW-20-NMCS	1 1/4"
AF26SW-24-NMCS	1 1/2"
AF26SW-32-NMCS	2"



PART NUMBER	NPT 150 lb 316 S/S 3 PIECE FEMALE/FEMALE BARREL UNION
AF126S-02-NT1	1/8"
AF126S-04-NT1	1/4"
AF126S-06-NT1	3/8"
AF126S-08-NT1	1/2"
AF126S-12-NT1	3/4"
AF126S-16-NT1	1"
AF126S-20-NT1	1 1/4"
AF126S-24-NT1	1 1/2"
AF126S-32-NT1	2"
AF126S-40-NT1	2 1/2"
AF126S-48-NT1	3"
AF126S-64-NT1	4"



PART NUMBER	NPT X NPT 150 lb 316 S/S 3 PIECE FEMALE/MALE BARREL UNION
AF116S-04-NT1	1/4"
AF116S-06-NT1	3/8"
AF116S-08-NT1	1/2"
AF116S-12-NT1	3/4"
AF116S-16-NT1	1"
AF116S-20-NT1	1 1/4"
AF116S-24-NT1	1 1/2"
AF116S-32-NT1	2"
AF116S-40-NT1	2 1/2"
AF116S-48-NT1	3"
AF116S-64-NT1	4"

Industrial Fittings



PART NUMBER	JIC 316 S/S FEMALE SWIVEL WELD ON
AF26SW-07-JC	7/16"
AF26SW-09-JC	9/16"
AF26SW-12-JC	3/4"
AF26SW-14-JC	7/8"
AF26SW-17-JC	1 1/16"
AF26SW-21-JC	1 5/16"
AF26SW-26-JC	1 5/8"
AF26SW-30-JC	1 7/8"
AF26SW-40-JC	2 1/2"



PART NUMBER	316 S/S SHD 10 STUB END
ST6SP-12-S10	1/2"
ST6SP-20-S10	3/4"
ST6SP-25-S10	1"
ST6SP-32-S10	1 1/4"
ST6SP-40-S10	1 1/2"
ST6SP-50-S10	2"
ST6SP-65-S10	2 1/2"
ST6SP-80-S10	3"
ST6SP-100-S10	4"
ST6SP-150-S10	6"
ST6SP-200-S10	8"



PART NUMBER	316 S/S SHD 40 STUB END
ST6SP-12-S40	1/2"
ST6SP-20-S40	3/4"
ST6SP-25-S40	1"
ST6SP-32-S40	1 1/4"
ST6SP-40-S40	1 1/2"
ST6SP-50-S40	2"
ST6SP-65-S40	2 1/2"
ST6SP-80-S40	3"
ST6SP-100-S40	4"
ST6SP-150-S40	6"
ST6SP-200-S40	8"



PART NUMBER	INDUSTRIAL 316 S/S LIFESAVER TAIL (6000 kPa)
LT6SIH60-12	3/4"
LT6SIH60-16	1"
LT6SIH60-20	1 1/4"
LT6SIH60-24	1 1/2"
LT6SIH60-32	2"
LT6SIH60-40	2 1/2"
LT6SIH60-48	3"
LT6SIH60-64	4"
LT6SIH60-80	5"
LT6SIH60-96	6"
LT6SIH60-128	8"
LT6SIH60-160	10"
LT6SIH60-192	12"

Industrial Fittings



PART NUMBER	INDUSTRIAL 316 S/S FERRULE (6000 kPa)
IF6S60-12	3/4"
IF6S60-16	1"
IF6S60-20	1 1/4"
IF6S60-24	1 1/2"
IF6S60-32	2"
IF6S60-40	2 1/2"
IF6S60-48	3"
IF6S60-64	4"



PART NUMBER	INDUSTRIAL 304 S/S SLOTTED FERRULE (2000 kPa)	
	HOSE SIZE	FERRULE I.D. (mm)
IF4S20-31.8-12	3/4"	31.8
IF4S20-33.3-12	3/4"	33.3
IF4S20-34.9-12	3/4"	34.9
IF4S20-36.5-16	1"	36.5
IF4S20-38.1-16	1"	38.1
IF4S20-39.7-16	1"	39.7
IF4S20-44.5-20	1 1/4"	44.5
IF4S20-46-20	1 1/4"	46
IF4S20-46-24	1 1/2"	46
IF4S20-49.2-24	1 1/2"	49.2
IF4S20-50.8-24	1 1/2"	50.8
IF4S20-52.4-24	1 1/2"	52.4
IF4S20-63.5-32	2"	63.5
IF4S20-65.1-32	2"	65.1
IF4S20-66.7-32	2"	66.7
IF4S20-68.3-32	2"	68.3
IF4S20-76.2-40	2 1/2"	76.2
IF4S20-79.4-40	2 1/2"	79.4
IF4S20-90.5-48	3"	90.5
IF4S20-92.1-48	3"	92.1
IF4S20-93.7-48	3"	93.7
IF4S20-115.9-64	4"	115.9
IF4S20-119.1-64	4"	119.1
IF4S20-122.2-64	4"	122.2
IF4S20-168.3-96	6"	168.3
IF4S20-171.5-96	6"	171.5



PART NUMBER	INDUSTRIAL 316 S/S LIFESAVER TAIL (2000 kPa)
LT6SIH20-16	1"
LT6SIH20-20	1 1/4"
LT6SIH20-24	1 1/2"
LT6SIH20-32	2"
LT6SIH20-40	2 1/2"
LT6SIH20-48	3"
LT6SIH20-64	4"
LT6SIH20-80	5"
LT6SIH20-96	6"
LT6SIH20-128	8"
LT6SIH20-160	10"
LT6SIH20-192	12"

Industrial Fittings



PART NUMBER	BSPT 316 S/S MALE x INDUSTRIAL HOSETAIL
AF56SIH20-1616-BT	1" x 1"
AF56SIH20-2020-BT	1 1/4" x 1 1/4"
AF56SIH20-2424-BT	1 1/2" x 1 1/2"
AF56SIH20-3232-BT	2" x 2"
AF56SIH20-4040-BT	2 1/2" x 2 1/2"
AF56SIH20-4848-BT	3"
AF56SIH20-9696-BT	4"

PART NUMBER	BSPP CONE SEAT 316 S/S FEMALE SWIVEL x INDUSTRIAL HOSETAIL
AF26SIH20-1616-BPCS	1" x 1"
AF26SIH20-2020-BPCS	1 1/4" x 1 1/4"
AF26SIH20-2424-BPCS	1 1/2" x 1 1/2"
AF26SIH20-3232-BPCS	2" x 2"
AF26SIH20-4040-BPCS	2 1/2" x 2 1/2"
AF26SIH20-4848-BPCS	3"
AF26SIH20-9696-BPCS	4"



PART NUMBER	BSPT/P 150lb 316 S/S SEATED HEX MALE NIPPLE
HMN6S-2020-BT1SBP1S	1 1/4" x 1 1/4"
HMN6S-2424-BT1SBP1S	1 1/2" x 1 1/2"
HMN6S-3232-BT1SBP1S	2" x 2"

Industrial Fittings



PART NUMBER	ROLLED GROOVE CARBON STEEL STD SPIGOT		
	SIZE	WALL THICKNESS (mm)	O.D. (mm)
RGMSW-25	1"	3.38	33.7
RGMSW-32	1 1/4"	3.56	42.4
RGMSW-40	1 1/2"	3.65	48.3
RGMSW-50	2"	3.91	60.3
RGMSW-65-US	2 1/2"	5.16	73.0
RGMSW-65	2 1/2"	5.16	76.1
RGMSW-80	3"	5.49	88.9
RGMSW-100	4"	6.02	114.3
RGMSW-125	5"	6.55	141.3
RGMSW-150	6"	7.11	165.1
RGMSW-150-US	6"	7.11	168.3
RGMSW-200	8"	8.18	219.1
RGMSW-250	10"	9.27	273.0
RGMSW-300	12"	10.31	323.9

PART NUMBER	ROLLED GROOVE 316 S/S SCH40 SPIGOT		
	SIZE	WALL THICKNESS (mm)	O.D. (mm)
RG6SW-25	1"	3.38	33.7
RG6SW-32	1 1/4"	3.56	42.4
RG6SW-40	1 1/2"	3.68	48.3
RG6SW-50	2"	3.91	60.3
RG6SW-65-US	2 1/2"	5.16	73.0
RG6SW-65	2 1/2"	5.16	76.1
RG6SW-80	3"	5.49	88.9
RG6SW-100	4"	6.02	114.3
RG6SW-125	5"	6.55	141.3
RG6SW-150	6"	7.11	165.1
RG6SW-150-US	6"	7.11	168.3
RG6SW-200	8"	8.18	219.1
RG6SW-250	10"	9.27	273.0
RG6SW-300	12"	9.53	323.9

Refer to specifications on page: 319

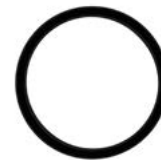

PART NUMBER	GALVANISED PAINTED ROLLED GROOVE RIGID COUPLING (2068 kPa)
RGCLAMP-25	1"
RGCLAMP-32	1 1/4"
RGCLAMP-40	1 1/2"
RGCLAMP-50	2"
RGCLAMP-65	2 1/2"
RGCLAMP-65US	2 1/2"
RGCLAMP-80	3"
RGCLAMP-100	4"
RGCLAMP-125	5"
RGCLAMP-150	6"
RGCLAMP-150-US	6"
RGCLAMP-200	8"
RGCLAMP-250	10"
RGCLAMP-300	12"

PART NUMBER		ROLLED GROOVE SEAL
NITRILE	EPDM	
RGSBN-25	RGSEPD-25	1"
RGSBN-32	RGSEPD-32	1 1/4"
RGSBN-40	RGSEPD-40	1 1/2"
RGSBN-50	RGSEPD-50	2"
RGSBN-65	RGSEPD-65	2 1/2"
RGSBN-65-US	RGSEPD-65-US	2 1/2"
RGSBN-80	RGSEPD-80	3"
RGSBN-100	RGSEPD-100	4"
RGSBN-125	RGSEPD-125	5"
RGSBN-150	RGSEPD-150	6"
RGSBN-150-US	RGSEPD-150-US	6"
RGSBN-200	RGSEPD-200	8"
RGSBN-250	RGSEPD-250	10"
RGSBN-300	RGSEPD-300	12"

Industrial Fittings



PART NUMBER	DOUBLE ROLLED GROOVE CARBON STEEL STD ADPATOR		
	SIZE	WALL THICKNESS (mm)	O.D. (mm)
RGDMS-25	1"	3.38	33.7
RGDMS-32	1 1/4"	3.56	42.4
RGDMS-40	1 1/2"	3.65	48.3
RGDMS-50	2"	3.91	60.3
RGDMS-65-US	2 1/2"	5.16	73.0
RGDMS-65	2 1/2"	5.16	76.1
RGDMS-80	3"	5.49	88.9
RGDMS-100	4"	6.02	114.3
RGDMS-125	5"	6.55	141.3
RGDMS-150	6"	7.11	165.1
RGDMS-150-US	6"	7.11	168.3
RGDMS-200	8"	8.18	219.1
RGDMS-250	10"	9.27	273.0
RGDMS-300	12"	10.31	323.9

PART NUMBER	DOUBLE ROLLED GROOVE 316 S/S SCH40 ADPATOR		
	SIZE	WALL THICKNESS (mm)	O.D. (mm)
RGD6S-25	1"	3.38	33.7
RGD6S-32	1 1/4"	3.56	42.4
RGD6S-40	1 1/2"	3.68	48.3
RGD6S-50	2"	3.91	60.3
RGD6S-65-US	2 1/2"	5.16	73.0
RGD6S-65	2 1/2"	5.16	76.1
RGD6S-80	3"	5.49	88.9
RGD6S-100	4"	6.02	114.3
RGD6S-125	5"	6.55	141.3
RGD6S-150	6"	7.11	165.1
RGD6S-150-US	6"	7.11	168.3
RGD6S-200	8"	8.18	219.1
RGD6S-250	10"	9.27	273.0
RGD6S-300	12"	9.53	323.9

*Custom Adapters Available On Request

Industrial Fittings



PART NUMBER	TYPE 'E' 316 S/S MALE CAMLOCK x INDUSTRIAL HOSETAIL
QL16SIH-08	1/2"
QL16SIH-12	3/4"
QL16SIH-16	1"
QL16SIH-20	1 1/4"
QL16SIH-24	1 1/2"
QL16SIH-32	2"
QL16SIH-40	2 1/2"
QL16SIH-48	3"
QL16SIH-64	4"
QL16SIH-96	6"



PART NUMBER	TYPE 'C' 316 S/S FEMALE CAMLOCK x INDUSTRIAL HOSETAIL (BN SEALS)
QL26SIH-08	1/2"
QL26SIH-12	3/4"
QL26SIH-16	1"
QL26SIH-20	1 1/4"
QL26SIH-24	1 1/2"
QL26SIH-32	2"
QL26SIH-40	2 1/2"
QL26SIH-48	3"
QL26SIH-64	4"
QL26SIH-96	6"



PART NUMBER	TYPE 'C' SAFLOK 316 S/S FEMALE CAMLOCK x INDUSTRIAL HOSETAIL (BN SEALS)
QL26SSAFIH-16	1"
QL26SSAFIH-24	1 1/2"
QL26SSAFIH-32	2"
QL26SSAFIH-40	2 1/2"
QL26SSAFIH-48	3"
QL26SSAFIH-64	4"



PART NUMBER	TYPE 'C' INSTA-LOCK 316 S/S FEMALE CAMLOCK x INDUSTRIAL HOSETAIL (BN SEALS)
QL26SINIH-08	1/2"
QL26SINIH-12	3/4"
QL26SINIH-16	1"
QL26SINIH-20	1 1/4"
QL26SINIH-24	1 1/2"
QL26SINIH-32	2"
QL26SINIH-40	2 1/2"
QL26SINIH-48	3"
QL26SINIH-64	4"
QL26SINIH-96	6"

Specialised Encapsulated Fittings Available on request.



Fittings for Composite Hose

QL2

Female Camlock

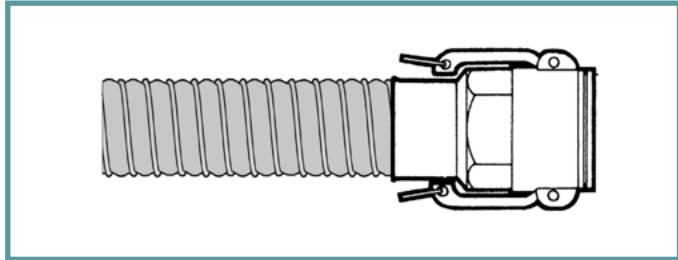

QL1

Male Camlock

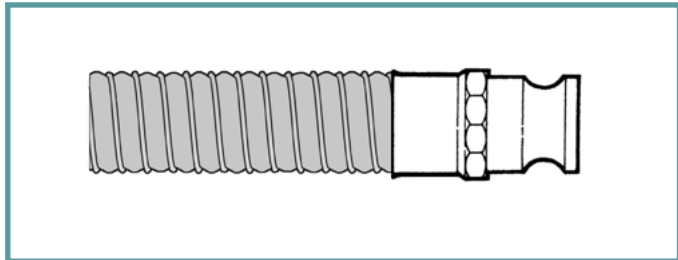

AF1

Fixed Male

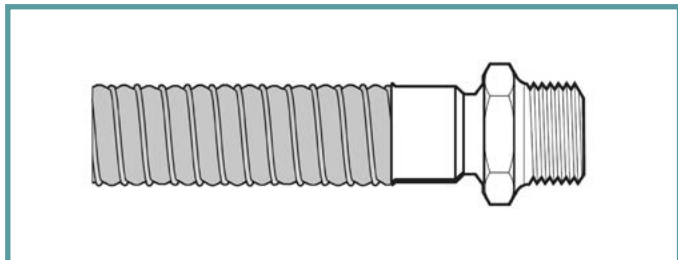

AF2

Swivel Female

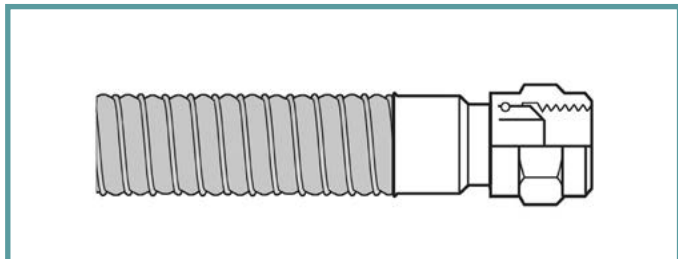

AF3

Fixed Flange

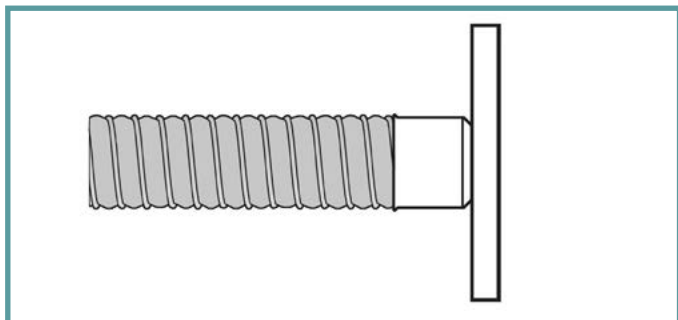

AF4

Floating Flange

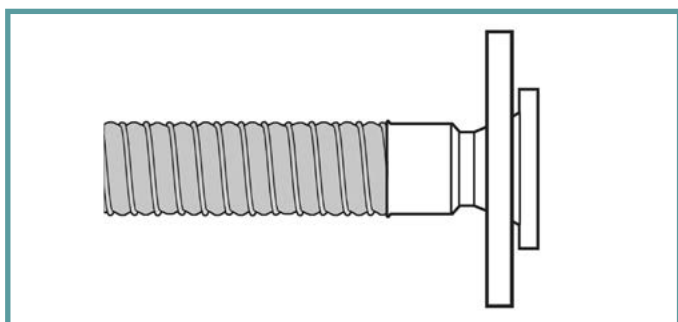

Composite Hose Fittings



PART NUMBER	TYPE 'E' 316 S/S MALE CAMLOCK x COMPOSITE HOSETAIL
316 STAINLESS STEEL	
QL16SCH-16	1"
QL16SCH-20	1 1/4"
QL16SCH-24	1 1/2"
QL16SCH-32	2"
QL16SCH-40	2 1/2"
QL16SCH-48	3"
QL16SCH-64	4"
QL16SCH-96	6"
ALUMINIUM	
QL1ACH-16	1"
QL1ACH-20	1 1/4"
QL1ACH-24	1 1/2"
QL1ACH-32	2"
QL1ACH-40	2 1/2"
QL1ACH-48	3"
QL1ACH-64	4"
QL1ACH-96	6"



PART NUMBER	TYPE 'C' 316 S/S FEMALE CAMLOCK x COMPOSITE HOSETAIL (BN SEALS)
316 STAINLESS STEEL	
QL26SCH-16	1"
QL26SCH-20	1 1/4"
QL26SCH-24	1 1/2"
QL26SCH-32	2"
QL26SCH-40	2 1/2"
QL26SCH-48	3"
QL26SCH-64	4"
QL26SCH-96	6"
ALUMINIUM	
QL2ACH-16	1"
QL2ACH-20	1 1/4"
QL2ACH-24	1 1/2"
QL2ACH-32	2"
QL2ACH-40	2 1/2"
QL2ACH-48	3"
QL2ACH-64	4"
QL2ACH-96	6"



PART NUMBER	TYPE 'C' SAFLOK 316 S/S FEMALE CAMLOCK x COMPOSITE HOSETAIL (BN SEALS)
QL26SSAFCH-16	1"
QL26SSAFCH-20	1 1/4"
QL26SSAFCH-24	1 1/2"
QL26SSAFCH-32	2"
QL26SSAFCH-40	2 1/2"
QL26SSAFCH-48	3"
QL26SSAFCH-64	4"



PART NUMBER	TYPE 'C' INSTA-LOCK 316 S/S FEMALE CAMLOCK x COMPOSITE HOSETAIL (BN SEALS)
QL26SINCH-16	1"
QL26SINCH-20	1 1/4"
QL26SINCH-24	1 1/2"
QL26SINCH-32	2"
QL26SINCH-40	2 1/2"
QL26SINCH-48	3"
QL26SINCH-64	4"
QL26SINCH-96	6"

Composite Hose Fittings



PART NUMBER	ANSI 150 lb 316 FLANGE ASME B16.5 x COMPOSITE HOSETAIL
AF36SCH-25-A1	1"
AF36SCH-32-A1	1 1/4"
AF36SCH-40-A1	1 1/2"
AF36SCH-50-A1	2"
AF36SCH-65-A1	2 1/2"
AF36SCH-80-A1	3"
AF36SCH-100-A1	4"
AF36SCH-150-A1	6"
TAB 'E' 316 S/S FLANGE AS2129 x COMPOSITE HOSETAIL	
AF36SCH-25-E	1"
AF36SCH-32-E	1 1/4"
AF36SCH-40-E	1 1/2"
AF36SCH-50-E	2"
AF36SCH-65-E	2 1/2"
AF36SCH-80-E	3"
AF36SCH-100-E	4"
AF36SCH-150-E	6"

PART NUMBER	TYPE 'M' S/S 316 MALE BSPT x COMPOSITE HOSETAIL
SSCC-M025	1"
SSCC-M032	1 1/4"
SSCC-M038	1 1/2"
SSCC-M050	2"
SSCC-M065	2 1/2"
SSCC-M080	3"
SSCC-M100	4"
SSCC-M150	6"

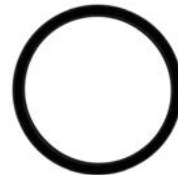

PART NUMBER	COMPOSITE HOSE FERRULE
304 STAINLESS STEEL	
CF4S-025	1"
CF4S-032	1 1/4"
CF4S-038	1 1/2"
CF4S-050	2"
CF4S-065	2 1/2"
CF4S-080	3"
CF4S-100	4"
CF4S-150	6"
ALUMINIUM	
CFAL-050	2"
CFAL-065	2 1/2"
CFAL-080	3"
CFAL-100	4"
CFAL-150	6"

PART NUMBER	COMPOSITE CRIMP SEAL
NITRILE	
CC-SB025	1"
CC-SB032	1 1/4"
CC-SB040	1 1/2"
CC-SB050	2"
CC-SB065	2 1/2"
CC-SB080	3"
CC-SB100	4"
CC-SB150	6"
VITON	
CC-SV025	1"
CC-SV032	1 1/4"
CC-SV040	1 1/2"
CC-SV050	2"
CC-SV065	2 1/2"
CC-SV080	3"
CC-SV100	4"
CC-SV150	6"

PTFE Fittings



PART NUMBER	BSPT SEATED 316 S/S HEX MALE x PTFE HOSETAIL
AF16SPH-0202-BTS	1/8" x 1/8"
AF16SPH-0203-BTS	1/8" x 3/16"
AF16SPH-0204-BTS	1/8" x 1/4"
AF16SPH-0404-BTS	1/4" x 1/4"
AF16SPH-0405-BTS	1/4" x 5/16"
AF16SPH-0406-BTS	1/4" x 3/8"
AF16SPH-0604-BTS	3/8" x 1/4"
AF16SPH-0606-BTS	3/8" x 3/8"
AF16SPH-0608-BTS	3/8" x 1/2"
AF16SPH-0804-BTS	1/2" x 1/4"
AF16SPH-0806-BTS	1/2" x 3/8"
AF16SPH-0808-BTS	1/2" x 1/2"
AF16SPH-0812-BTS	1/2" x 3/4"
AF16SPH-0816-BTS	1/2" x 1"
AF16SPH-1206-BTS	3/4" x 3/8"
AF16SPH-1208-BTS	3/4" x 1/2"
AF16SPH-1212-BTS	3/4" x 3/4"
AF16SPH-1216-BTS	3/4" x 1"
AF16SPH-1608-BTS	1" x 1/2"
AF16SPH-1612-BTS	1" x 3/4"
AF16SPH-1616-BTS	1" x 1"
AF16SPH-1620-BTS	1" x 1 1/4"
AF16SPH-2016-BTS	1 1/4" x 1"
AF16SPH-2020-BTS	1 1/4" x 1 1/4"
AF16SPH-2024-BTS	1 1/4" x 1 1/2"
AF16SPH-2420-BTS	1 1/2" x 1 1/4"
AF16SPH-2424-BTS	1 1/2" x 1 1/2"
AF16SPH-2432-BTS	1 1/2" x 2"
AF16SPH-3220-BTS	2" x 1 1/4"
AF16SPH-3224-BTS	2" x 1 1/2"
AF16SPH-3232-BTS	2" x 2"

PART NUMBER	BSPP CONE SEAT 316 S/S FEMALE SWIVEL x PTFE HOSETAIL
AF26SPH-0202-BPCS	1/8" x 1/8"
AF26SPH-0203-BPCS	1/8" x 3/16"
AF26SPH-0204-BPCS	1/8" x 1/4"
AF26SPH-0403-BPCS	1/4" x 3/16"
AF26SPH-0404-BPCS	1/4" x 1/4"
AF26SPH-0406-BPCS	1/4" x 3/8"
AF26SPH-0604-BPCS	3/8" x 1/4"
AF26SPH-0606-BPCS	3/8" x 3/8"
AF26SPH-0608-BPCS	3/8" x 1/2"
AF26SPH-0804-BPCS	1/2" x 1/4"
AF26SPH-0806-BPCS	1/2" x 3/8"
AF26SPH-0808-BPCS	1/2" x 1/2"
AF26SPH-0812-BPCS	1/2" x 3/4"
AF26SPH-0816-BPCS	1/2" x 1"
AF26SPH-1206-BPCS	3/4" x 3/8"
AF26SPH-1208-BPCS	3/4" x 1/2"
AF26SPH-1212-BPCS	3/4" x 3/4"
AF26SPH-1216-BPCS	3/4" x 1"
AF26SPH-1608-BPCS	1" x 1/2"
AF26SPH-1612-BPCS	1" x 3/4"
AF26SPH-1616-BPCS	1" x 1"
AF26SPH-1620-BPCS	1" x 1 1/4"
AF26SPH-2016-BPCS	1 1/4" x 1"
AF26SPH-2020-BPCS	1 1/4" x 1 1/4"
AF26SPH-2024-BPCS	1 1/4" x 1 1/2"
AF26SPH-2420-BPCS	1 1/2" x 1 1/4"
AF26SPH-2424-BPCS	1 1/2" x 1 1/2"
AF26SPH-2432-BPCS	1 1/2" x 2"
AF26SPH-3220-BPCS	2" x 1 1/4"
AF26SPH-3224-BPCS	2" x 1 1/2"
AF26SPH-3232-BPCS	2" x 2"

PTFE Fittings



PART NUMBER	BSPP SEATED 316 S/S FEMALE SWIVEL x 90° SWEPT BEND x PTFE HOSETAIL
AF26S90PH-0202-BPS	1/8" x 1/8"
AF26S90PH-0203-BPS	1/8" x 3/16"
AF26S90PH-0204-BPS	1/8" x 1/4"
AF26S90PH-0403-BPS	1/4" x 3/16"
AF26S90PH-0404-BPS	1/4" x 1/4"
AF26S90PH-0406-BPS	1/4" x 3/8"
AF26S90PH-0604-BPS	3/8" x 1/4"
AF26S90PH-0606-BPS	3/8" x 3/8"
AF26S90PH-0608-BPS	3/8" x 1/2"
AF26S90PH-0804-BPS	1/2" x 1/4"
AF26S90PH-0806-BPS	1/2" x 3/8"
AF26S90PH-0808-BPS	1/2" x 1/2"
AF26S90PH-0812-BPS	1/2" x 3/4"
AF26S90PH-0816-BPS	1/2" x 1"
AF26S90PH-1206-BPS	3/4" x 3/8"
AF26S90PH-1208-BPS	3/4" x 1/2"
AF26S90PH-1212-BPS	3/4" x 3/4"
AF26S90PH-1216-BPS	3/4" x 1"
AF26S90PH-1608-BPS	1" x 1/2"
AF26S90PH-1612-BPS	1" x 3/4"
AF26S90PH-1616-BPS	1" x 1"
AF26S90PH-1620-BPS	1" x 1 1/4"
AF26S90PH-2016-BPS	1 1/4" x 1"
AF26S90PH-2020-BPS	1 1/4" x 1 1/4"
AF26S90PH-2024-BPS	1 1/4" x 1 1/2"
AF26S90PH-2420-BPS	1 1/2" x 1 1/4"
AF26S90PH-2424-BPS	1 1/2" x 1 1/2"
AF26S90PH-2432-BPS	1 1/2" x 2"
AF26S90PH-3220-BPS	2" x 1 1/4"
AF26S90PH-3224-BPS	2" x 1 1/2"
AF26S90PH-3232-BPS	2" x 2"

PART NUMBER	BSPP SEATED 316 S/S FEMALE SWIVEL x 45° SWEPT BEND x PTFE HOSETAIL
AF26S45PH-0202-BPS	1/8" x 1/8"
AF26S45PH-0203-BPS	1/8" x 3/16"
AF26S45PH-0204-BPS	1/8" x 1/4"
AF26S45PH-0403-BPS	1/4" x 3/16"
AF26S45PH-0404-BPS	1/4" x 1/4"
AF26S45PH-0406-BPS	1/4" x 3/8"
AF26S45PH-0604-BPS	3/8" x 1/4"
AF26S45PH-0606-BPS	3/8" x 3/8"
AF26S45PH-0608-BPS	3/8" x 1/2"
AF26S45PH-0804-BPS	1/2" x 1/4"
AF26S45PH-0806-BPS	1/2" x 3/8"
AF26S45PH-0808-BPS	1/2" x 1/2"
AF26S45PH-0812-BPS	1/2" x 3/4"
AF26S45PH-0816-BPS	1/2" x 1"
AF26S45PH-1206-BPS	3/4" x 3/8"
AF26S45PH-1208-BPS	3/4" x 1/2"
AF26S45PH-1212-BPS	3/4" x 3/4"
AF26S45PH-1216-BPS	3/4" x 1"
AF26S45PH-1608-BPS	1" x 1/2"
AF26S45PH-1612-BPS	1" x 3/4"
AF26S45PH-1616-BPS	1" x 1"
AF26S45PH-1620-BPS	1" x 1 1/4"
AF26S45PH-2016-BPS	1 1/4" x 1"
AF26S45PH-2020-BPS	1 1/4" x 1 1/4"
AF26S45PH-2024-BPS	1 1/4" x 1 1/2"
AF26S45PH-2420-BPS	1 1/2" x 1 1/4"
AF26S45PH-2424-BPS	1 1/2" x 1 1/2"
AF26S45PH-2432-BPS	1 1/2" x 2"
AF26S45PH-3220-BPS	2" x 1 1/4"
AF26S45PH-3224-BPS	2" x 1 1/2"
AF26S45PH-3232-BPS	2" x 2"

PTFE Fittings



PART NUMBER	NPT SEATED 316 S/S HEX MALE x PTFE HOSETAIL
AF16SPH-0202-NTS	1/8" x 1/8"
AF16SPH-0203-NTS	1/8" x 3/16"
AF16SPH-0204-NTS	1/8" x 1/4"
AF16SPH-0404-NTS	1/4" x 1/4"
AF16SPH-0406-NTS	1/4" x 3/8"
AF16SPH-0604-NTS	3/8" x 1/4"
AF16SPH-0606-NTS	3/8" x 3/8"
AF16SPH-0608-NTS	3/8" x 1/2"
AF16SPH-0804-NTS	1/2" x 1/4"
AF16SPH-0806-NTS	1/2" x 3/8"
AF16SPH-0808-NTS	1/2" x 1/2"
AF16SPH-0812-NTS	1/2" x 3/4"
AF16SPH-0816-NTS	1/2" x 1"
AF16SPH-1206-NTS	3/4" x 3/8"
AF16SPH-1208-NTS	3/4" x 1/2"
AF16SPH-1212-NTS	3/4" x 3/4"
AF16SPH-1216-NTS	3/4" x 1"
AF16SPH-1608-NTS	1" x 1/2"
AF16SPH-1612-NTS	1" x 3/4"
AF16SPH-1616-NTS	1" x 1"
AF16SPH-1620-NTS	1" x 1 1/4"
AF16SPH-2016-NTS	1 1/4" x 1"
AF16SPH-2020-NTS	1 1/4" x 1 1/4"
AF16SPH-2024-NTS	1 1/4" x 1 1/2"
AF16SPH-2420-NTS	1 1/2" x 1 1/4"
AF16SPH-2424-NTS	1 1/2" x 1 1/2"
AF16SPH-2432-NTS	1 1/2" x 2"
AF16SPH-3220-NTS	2" x 1 1/4"
AF16SPH-3224-NTS	2" x 1 1/2"
AF16SPH-3232-NTS	2" x 2"

PART NUMBER	NPSM CONE SEAT 316 S/S FEMALE SWIVEL x HYDRAULIC HOSETAIL
AF26SPH-0202-NMCS	1/8" x 1/8"
AF26SPH-0203-NMCS	1/8" x 3/16"
AF26SPH-0204-NMCS	1/8" x 1/4"
AF26SPH-0404-NMCS	1/4" x 1/4"
AF26SPH-0406-NMCS	1/4" x 3/8"
AF26SPH-0604-NMCS	3/8" x 1/4"
AF26SPH-0606-NMCS	3/8" x 3/8"
AF26SPH-0608-NMCS	3/8" x 1/2"
AF26SPH-0804-NMCS	1/2" x 1/4"
AF26SPH-0806-NMCS	1/2" x 3/8"
AF26SPH-0808-NMCS	1/2" x 1/2"
AF26SPH-0812-NMCS	1/2" x 3/4"
AF26SPH-0816-NMCS	1/2" x 1"
AF26SPH-1206-NMCS	3/4" x 3/8"
AF26SPH-1208-NMCS	3/4" x 1/2"
AF26SPH-1212-NMCS	3/4" x 3/4"
AF26SPH-1216-NMCS	3/4" x 1"
AF26SPH-1608-NMCS	1" x 1/2"
AF26SPH-1612-NMCS	1" x 3/4"
AF26SPH-1616-NMCS	1" x 1"
AF26SPH-1620-NMCS	1" x 1 1/4"
AF26SPH-2016-NMCS	1 1/4" x 1"
AF26SPH-2020-NMCS	1 1/4" x 1 1/4"
AF26SPH-2024-NMCS	1 1/4" x 1 1/2"
AF26SPH-2420-NMCS	1 1/2" x 1 1/4"
AF26SPH-2424-NMCS	1 1/2" x 1 1/2"
AF26SPH-2432-NMCS	1 1/2" x 2"
AF26SPH-3220-NMCS	2" x 1 1/4"
AF26SPH-3224-NMCS	2" x 1 1/2"
AF26SPH-3232-NMCS	2" x 2"

**Specialised Encapsulated Fittings
Available on request.**



PTFE Fittings



PART NUMBER	NPSM CONE SEAT 316 S/S FEMALE SWIVEL x 90° SWEPT BEND x PTFE HOSETAIL
AF26S90PH-0202-NMCS	1/8" x 1/8"
AF26S90PH-0203-NMCS	1/8" x 3/16"
AF26S90PH-0204-NMCS	1/8" x 1/4"
AF26S90PH-0404-NMCS	1/4" x 1/4"
AF26S90PH-0406-NMCS	1/4" x 3/8"
AF26S90PH-0604-NMCS	3/8" x 1/4"
AF26S90PH-0606-NMCS	3/8" x 3/8"
AF26S90PH-0608-NMCS	3/8" x 1/2"
AF26S90PH-0804-NMCS	1/2" x 1/4"
AF26S90PH-0806-NMCS	1/2" x 3/8"
AF26S90PH-0808-NMCS	1/2" x 1/2"
AF26S90PH-0812-NMCS	1/2" x 3/4"
AF26S90PH-0816-NMCS	1/2" x 1"
AF26S90PH-1206-NMCS	3/4" x 3/8"
AF26S90PH-1208-NMCS	3/4" x 1/2"
AF26S90PH-1212-NMCS	3/4" x 3/4"
AF26S90PH-1216-NMCS	3/4" x 1"
AF26S90PH-1608-NMCS	1" x 1/2"
AF26S90PH-1612-NMCS	1" x 3/4"
AF26S90PH-1616-NMCS	1" x 1"
AF26S90PH-1620-NMCS	1" x 1 1/4"
AF26S90PH-2016-NMCS	1 1/4" x 1"
AF26S90PH-2020-NMCS	1 1/4" x 1 1/4"
AF26S90PH-2024-NMCS	1 1/4" x 1 1/2"
AF26S90PH-2420-NMCS	1 1/2" x 1 1/4"
AF26S90PH-2424-NMCS	1 1/2" x 1 1/2"
AF26S90PH-2432-NMCS	1 1/2" x 2"
AF26S90PH-3220-NMCS	2" x 1 1/4"
AF26S90PH-3224-NMCS	2" x 1 1/2"
AF26S90PH-3232-NMCS	2" x 2"

PART NUMBER	NPSM CONE SEAT 316 S/S FEMALE SWIVEL x 45° SWEPT BEND x PTFE HOSETAIL
AF26S45PH-0202-NMCS	1/8" x 1/8"
AF26S45PH-0203-NMCS	1/8" x 3/16"
AF26S45PH-0204-NMCS	1/8" x 1/4"
AF26S45PH-0404-NMCS	1/4" x 1/4"
AF26S45PH-0406-NMCS	1/4" x 3/8"
AF26S45PH-0604-NMCS	3/8" x 1/4"
AF26S45PH-0606-NMCS	3/8" x 3/8"
AF26S45PH-0608-NMCS	3/8" x 1/2"
AF26S45PH-0804-NMCS	1/2" x 1/4"
AF26S45PH-0806-NMCS	1/2" x 3/8"
AF26S45PH-0808-NMCS	1/2" x 1/2"
AF26S45PH-0812-NMCS	1/2" x 3/4"
AF26S45PH-0816-NMCS	1/2" x 1"
AF26S45PH-1206-NMCS	3/4" x 3/8"
AF26S45PH-1208-NMCS	3/4" x 1/2"
AF26S45PH-1212-NMCS	3/4" x 3/4"
AF26S45PH-1216-NMCS	3/4" x 1"
AF26S45PH-1608-NMCS	1" x 1/2"
AF26S45PH-1612-NMCS	1" x 3/4"
AF26S45PH-1616-NMCS	1" x 1"
AF26S45PH-1620-NMCS	1" x 1 1/4"
AF26S45PH-2016-NMCS	1 1/4" x 1"
AF26S45PH-2020-NMCS	1 1/4" x 1 1/4"
AF26S45PH-2024-NMCS	1 1/4" x 1 1/2"
AF26S45PH-2420-NMCS	1 1/2" x 1 1/4"
AF26S45PH-2424-NMCS	1 1/2" x 1 1/2"
AF26S45PH-2432-NMCS	1 1/2" x 2"
AF26S45PH-3220-NMCS	2" x 1 1/4"
AF26S45PH-3224-NMCS	2" x 1 1/2"
AF26S45PH-3232-NMCS	2" x 2"

PTFE Fittings



PART NUMBER	JIC 316 S/S HEX MALE x PTFE HOSETAIL
AF16SPH-0702-JC	7/16" x 1/8"
AF16SPH-0703-JC	7/16" x 3/16"
AF16SPH-0704-JC	7/16" x 1/4"
AF16SPH-0706-JC	7/16" x 3/8"
AF16SPH-0904-JC	9/16" x 1/4"
AF16SPH-0906-JC	9/16" x 3/8"
AF16SPH-0908-JC	9/16" x 1/2"
AF16SPH-1204-JC	3/4" x 1/4"
AF16SPH-1206-JC	3/4" x 3/8"
AF16SPH-1208-JC	3/4" x 1/2"
AF16SPH-1210-JC	3/4" x 5/8"
AF16SPH-1406-JC	7/8" x 3/8"
AF16SPH-1408-JC	7/8" x 1/2"
AF16SPH-1410-JC	7/8" x 5/8"
AF16SPH-1412-JC	7/8" x 3/4"
AF16SPH-1710-JC	1 1/16" x 5/8"
AF16SPH-1712-JC	1 1/16" x 3/4"
AF16SPH-1716-JC	1 1/16" x 1"
AF16SPH-1912-JC	1 3/16" x 3/4"
AF16SPH-1916-JC	1 3/16" x 1"
AF16SPH-2112-JC	1 5/16" x 3/4"
AF16SPH-2116-JC	1 5/16" x 1"
AF16SPH-2120-JC	1 5/16" x 1 1/4"
AF16SPH-2616-JC	1 5/8" x 1"
AF16SPH-2620-JC	1 5/8" x 1 1/4"
AF16SPH-3020-JC	1 7/8" x 1 1/4"
AF16SPH-3024-JC	1 7/8" x 1 1/2"
AF16SPH-3032-JC	1 7/8" x 2"
AF16SPH-4024-JC	2 1/2" x 1 1/2"
AF16SPH-4032-JC	2 1/2" x 2"

PART NUMBER	JIC 316 S/S FEMALE SWIVEL x PTFE HOSETAIL
AF26SPH-0702-JC	7/16" x 1/8"
AF26SPH-0703-JC	7/16" x 3/16"
AF26SPH-0704-JC	7/16" x 1/4"
AF26SPH-0706-JC	7/16" x 3/8"
AF26SPH-0904-JC	9/16" x 1/4"
AF26SPH-0906-JIC	9/16" x 3/8"
AF26SPH-0908-JC	9/16" x 1/2"
AF26SPH-1204-JC	3/4" x 1/4"
AF26SPH-1206-JC	3/4" x 3/8"
AF26SPH-1208-JC	3/4" x 1/2"
AF26SPH-1210-JC	3/4" x 5/8"
AF26SPH-1406-JC	7/8" x 3/8"
AF26SPH-1408-JC	7/8" x 1/2"
AF26SPH-1410-JC	7/8" x 5/8"
AF26SPH-1412-JC	7/8" x 3/4"
AF26SPH-1710-JC	1 1/16" x 5/8"
AF26SPH-1712-JC	1 1/16" x 3/4"
AF26SPH-1716-JC	1 1/16" x 1"
AF26SPH-1912-JC	1 3/16" x 3/4"
AF26SPH-1916-JC	1 3/16" x 1"
AF26SPH-2112-JC	1 5/16" x 3/4"
AF26SPH-2116-JC	1 5/16" x 1"
AF26SPH-2120-JC	1 5/16" x 1 1/4"
AF26SPH-2616-JC	1 5/8" x 1"
AF26SPH-2620-JC	1 5/8" x 1 1/4"
AF26SPH-3020-JC	1 7/8" x 1 1/4"
AF26SPH-3024-JC	1 7/8" x 1 1/2"
AF26SPH-3032-JC	1 7/8" x 2"
AF26SPH-4024-JC	2 1/2" x 1 1/2"
AF26SPH-4032-JC	2 1/2" x 2"

Specialised Encapsulated Fittings Available on request.



PTFE Fittings



PART NUMBER	JIC 316 S/S FEMALE SWIVEL x 90° SWEPT BEND x PTFE HOSETAIL
AF26S90PH-0702-JC	7/16" x 1/8"
AF26S90HH-0703-JC	7/16" x 3/16"
AF26S90PH-0704-JC	7/16" x 1/4"
AF26S90PH-0706-JC	7/16" x 3/8"
AF26S90PH-0904-JC	9/16" x 1/4"
AF26S90PH-0906-JC	9/16" x 3/8"
AF26S90PH-0908-JC	9/16" x 1/2"
AF26S90PH-1204-JC	3/4" x 1/4"
AF26S90PH-1206-JC	3/4" x 3/8"
AF26S90PH-1208-JC	3/4" x 1/2"
AF26S90PH-1210-JC	3/4" x 5/8"
AF26S90PH-1406-JC	7/8" x 3/8"
AF26S90PH-1408-JC	7/8" x 1/2"
AF26S90PH-1410-JC	7/8" x 5/8"
AF26S90PH-1412-JC	7/8" x 3/4"
AF26S90PH-1710-JC	1 1/16" x 5/8"
AF26S90PH-1712-JC	1 1/16" x 3/4"
AF26S90PH-1716-JC	1 1/16" x 1"
AF26S90PH-1912-JC	1 3/16" x 3/4"
AF26S90PH-1916-JC	1 3/16" x 1"
AF26S90PH-2112-JC	1 5/16" x 3/4"
AF26S90PH-2116-JC	1 5/16" x 1"
AF26S90PH-2120-JC	1 5/16" x 1 1/4"
AF26S90PH-2616-JC	1 5/8" x 1"
AF26S90PH-2620-JC	1 5/8" x 1 1/4"
AF26S90PH-3020-JC	1 7/8" x 1 1/4"
AF26S90PH-3024-JC	1 7/8" x 1 1/2"
AF26S90PH-3032-JC	1 7/8" x 2"
AF26S90PH-4024-JC	2 1/2" x 1 1/2"
AF26S90PH-4032-JC	2 1/2" x 2"

PART NUMBER	JIC 316 S/S FEMALE SWIVEL x 45° SWEPT BEND x PTFE HOSETAIL
AF26S45PH-0702-JC	7/16" x 1/8"
AF26S45PH-0703-JC	7/16" x 3/16"
AF26S45PH-0704-JC	7/16" x 1/4"
AF26S45PH-0706-JC	7/16" x 3/8"
AF26S45PH-0904-JC	9/16" x 1/4"
AF26S45PH-0906-JC	9/16" x 3/8"
AF26S45PH-0908-JC	9/16" x 1/2"
AF26S45PH-1204-JC	3/4" x 1/4"
AF26S45PH-1206-JC	3/4" x 3/8"
AF26S45PH-1208-JC	3/4" x 1/2"
AF26S45PH-1210-JC	3/4" x 5/8"
AF26S45PH-1406-JC	7/8" x 3/8"
AF26S45PH-1408-JC	7/8" x 1/2"
AF26S45PH-1410-JC	7/8" x 5/8"
AF26S45PH-1412-JC	7/8" x 3/4"
AF26S45PH-1710-JC	1 1/16" x 5/8"
AF26S45PH-1712-JC	1 1/16" x 3/4"
AF26S45PH-1716-JC	1 1/16" x 1"
AF26S45PH-1912-JC	1 3/16" x 3/4"
AF26S45PH-1916-JC	1 3/16" x 1"
AF26S45PH-2112-JC	1 5/16" x 3/4"
AF26S45PH-2116-JC	1 5/16" x 1"
AF26S45PH-2120-JC	1 5/16" x 1 1/4"
AF26S45PH-2616-JC	1 5/8" x 1"
AF26S45PH-2620-JC	1 5/8" x 1 1/4"
AF26S45PH-3020-JC	1 7/8" x 1 1/4"
AF26S45PH-3024-JC	1 7/8" x 1 1/2"
AF26S45PH-3032-JC	1 7/8" x 2"
AF26S45PH-4024-JC	2 1/2" x 1 1/2"
AF26S45PH-4032-JC	2 1/2" x 2"

PTFE Fittings



PART NUMBER	METRIC LIGHT DKL MALE 316 S/S x PTFE HOSETAIL	TUBE SIZE (mm)
AF16SPH-1215-04-DKL	M12 x 1.5 x 1/4"	6 L
AF16SPH-1415-04-DKL	M14 x 1.5 x 1/4"	8 L
AF16SPH-1615-04-DKL	M16 x 1.5 x 1/4"	10 L
AF16SPH-1615-06-DKL	M16 x 1.5 x 3/8"	10 L
AF16SPH-1815-06-DKL	M18 x 1.5 x 3/8"	12 L
AF16SPH-2215-06-DKL	M22 x 1.5 x 3/8"	15 L
AF16SPH-2215-08-DKL	M22 x 1.5 x 1/2"	15 L
AF16SPH-2615-08-DKL	M26 x 1.5 x 1/2"	18 L
AF16SPH-3015-10-DKL	M30 x 1.5 x 5/8"	22 L
AF16SPH-3020-12-DKL	M30 x 2.0 x 3/4"	22 L
AF16SPH-3620-12-DKL	M36 x 2.0 x 3/4"	28 L
AF16SPH-3620-16-DKL	M36 x 2.0 x 1"	28 L
AF16SPH-4520-20-DKL	M45 x 2.0 x 1 1/4"	35 L
AF16SPH-5220-24-DKL	M52 x 2.0 x 1 1/2"	42 L

PART NUMBER	METRIC LIGHT DKL FEMALE 316 S/S x PTFE HOSETAIL	TUBE SIZE (mm)
AF26SPH-1215-04-DKL	M12 x 1.5 x 1/4"	6 L
AF26SPH-1415-04-DKL	M14 x 1.5 x 1/4"	8 L
AF26SPH-1615-04-DKL	M16 x 1.5 x 1/4"	10 L
AF26SPH-1815-04-DKL	M18 x 1.5 x 1/4"	12 L
AF26SPH-1615-05-DKL	M16 x 1.5 x 5/16"	10 L
AF26SPH-1815-05-DKL	M18 x 1.5 x 5/16"	12 L
AF26SPH-1615-06-DKL	M16 x 1.5 x 3/8"	10 L
AF26SPH-1815-06-DKL	M18 x 1.5 x 3/8"	12 L
AF26SPH-2215-06-DKL	M22 x 1.5 x 3/8"	15 L
AF26SPH-2215-08-DKL	M22 x 1.5 x 1/2"	15 L
AF26SPH-2615-08-DKL	M26 x 1.5 x 1/2"	18 L
AF26SPH-2615-10-DKL	M26 x 1.5 x 5/8"	18 L
AF26SPH-2615-12-DKL	M26 x 1.5 x 3/4"	18 L
AF26SPH-3020-12-DKL	M30 x 2.0 x 3/4"	22 L
AF26SPH-3620-12-DKL	M36 x 2.0 x 3/4"	28 L
AF26SPH-3620-16-DKL	M36 x 2.0 x 1"	28 L
AF26SPH-4520-20-DKL	M45 x 2.0 x 1 1/4"	35 L
AF26SPH-5220-24-DKL	M52 x 2.0 x 1 1/2"	42 L

PTFE Fittings



PART NUMBER	METRIC HEAVY DKS MALE 316 S/S x PTFE HOSETAIL	TUBE SIZE (mm)
AF16SPH-1615-04-DKS	M16 x 1.5 x 1/4"	8 S
AF16SPH-1815-04-DKS	M18 x 1.5 x 1/4"	10 S
AF16SPH-2015-05-DKS	M20 x 1.5 x 5/16"	12 S
AF16SPH-2015-06-DKS	M20 x 1.5 x 3/8"	12 S
AF16SPH-2215-06-DKS	M22 x 1.5 x 3/8"	14 S
AF16SPH-2415-08-DKS	M24 x 1.5 x 1/2"	16 S
AF16SPH-3020-10-DKS	M30 x 2.0 x 5/8"	20 S
AF16SPH-3020-12-DKS	M30 x 2.0 x 3/4"	20 S
AF16SPH-3620-12-DKS	M36 x 2.0 x 3/4"	25 S
AF16SPH-3620-16-DKS	M36 x 2.0 x 1"	30 S
AF16SPH-5220-20-DKS	M52 x 2.0 x 1 1/4"	38 S

PART NUMBER	METRIC HEAVY DKS FEMALE 316 S/S x PTFE HOSETAIL	TUBE SIZE (mm)
AF26SPH-1615-04-DKS	M16 x 1.5 x 1/4"	8 S
AF26SPH-1815-04-DKS	M18 x 1.5 x 1/4"	10 S
AF26SPH-2015-05-DKS	M20 x 1.5 x 5/16"	12 S
AF26SPH-2015-06-DKS	M20 x 1.5 x 3/8"	12 S
AF26SPH-2215-06-DKS	M22 x 1.5 x 3/8"	14 S
AF26SPH-2415-08-DKS	M24 x 1.5 x 1/2"	16 S
AF26SPH-3020-10-DKS	M30 x 2.0 x 5/8"	20 S
AF26SPH-3020-12-DKS	M36 x 2.0 x 3/4"	25 S
AF26SPH-4220-16-DKS	M42 x 2.0 x 1"	30 S
AF26SPH-5220-20-DKS	M52 x 2.0 x 1 1/4"	38 S

PTFE Fittings



PART NUMBER	STANDPIPE 316 S/S x PTFE HOSETAIL (IMPERIAL)
AF106SPH-I-0202	1/8" x 1/8"
AF106SPH-I-0203	1/8" x 3/16"
AF106SPH-I-0204	1/8" x 1/4"
AF106SPH-I-0303	3/16" x 3/16"
AF106SPH-I-0304	3/16" x 1/4"
AF106SPH-I-0402	1/4" x 1/8"
AF106SPH-I-0403	1/4" x 3/16"
AF106SPH-I-0404	1/4" x 1/4"
AF106SPH-I-0406	1/4" x 3/8"
AF106SPH-I-0408	1/4" x 1/2"
AF106SPH-I-0604	3/8" x 1/4"
AF106SPH-I-0606	3/8" x 3/8"
AF106SPH-I-0608	3/8" x 1/2"
AF106SPH-I-0806	1/2" x 3/8"
AF106SPH-I-0808	1/2" x 1/2"
AF106SPH-I-0810	1/2" x 5/8"
AF106SPH-I-0812	1/2" x 3/4"
AF106SPH-I-1008	5/8" x 1/2"
AF106SPH-I-1010	5/8" x 5/8"
AF106SPH-I-1012	5/8" x 3/4"
AF106SPH-I-1208	1/2" x 3/4"
AF106SPH-I-1210	3/4" x 5/8"
AF106SPH-I-1212	3/4" x 3/4"
AF106SPH-I-1216	3/4" x 1"
AF106SPH-I-1612	1" x 3/4"
AF106SPH-I-1616	1" x 1"
AF106SPH-I-2020	1 1/4" x 1 1/4"
AF106SPH-I-2424	1 1/2" x 1 1/2"
AF106SPH-I-3232	2" x 2"



PART NUMBER	STANDPIPE 316 S/S x PTFE HOSETAIL (METRIC)
AF106SPH-M-0202	3mm x 1/8"
AF106SPH-M-0303	4mm x 3/16"
AF106SPH-M-0404	6mm x 1/4"
AF106SPH-M-0606	10mm x 3/8"
AF106SPH-M-0808	12mm x 1/2"
AF106SPH-M-1010	15mm x 5/8"
AF106SPH-M-1212	20mm x 3/4"
AF106SPH-M-1616	25mm x 1"
AF106SPH-M-2020	32mm x 1 1/4"



PART NUMBER	PTFE 316 S/S LIFESAVER TAIL
LT6SPH-02	1/8"
LT6SPH-03	3/16"
LT6SPH-04	1/4"
LT6SPH-05	5/16"
LT6SPH-06	3/8"
LT6SPH-08	1/2"
LT6SPH-10	5/8"
LT6SPH-12	3/4"
LT6SPH-16	1"
LT6SPH-20	1 1/4"
LT6SPH-24	1 1/2"
LT6SPH-32	2"
LT6SPH-40	2 1/2"
LT6SPH-48	3"
LT6SPH-64	4"
LT6SPH-80	5"
LT6SPH-96	6"

PTFE Fittings



PART NUMBER	PTFE UNIVERSAL 316 S/S FERRULE
PUF6S-02	1/8"
PUF6S-03	3/16"
PUF6S-04	1/4"
PUF6S-05	5/16"
PUF6S-06	3/8"
PUF6S-08	1/2"
PUF6S-10	5/8"
PUF6S-12	3/4"
PUF6S-16	1"
PUF6S-20	1 1/4"
PUF6S-24	1 1/2"
PUF6S-32	2"
PUF6S-40	2 1/2"
PUF6S-48	3"
PUF6S-64	4"



PART NUMBER	PTFE ZINC PLATED FERRULE
SMFZP-2424	1 1/2"
SMFZP-3232	2"



PART NUMBER	BSPT SEATED M/S ZINC PLATED FIXED MALE x PTFE HOSETAIL
AF1ZPPHFM-2424-BTS	1 1/2"
AF1ZPPHFM-3232-BTS	2"



PART NUMBER	PTFE SAE 100 R14 316 S/S FERRULE
R14F6S-02	1/8"
R14F6S-03	3/16"
R14F6S-04	1/4"
R14F6S-05	5/16"
R14F6S-06	3/8"
R14F6S-08	1/2"
R14F6S-10	5/8"
R14F6S-12	3/4"
R14F6S-16	1"



PART NUMBER	BSPT SEATED M/S ZINC PLATED SWIVEL MALE x PTFE HOSETAIL C/W VITON 'O' SEAL
AF1ZPPHSM-2424-BTS	1 1/2"
AF1ZPPHSM-3232-BTS	2"

PTFE Fittings



PART NUMBER	ANSI 150 lb 316 S/S FLANGE ASME B16.5 x PTFE HOSETAIL
AF36SPH-25-A1	1"
AF36SPH-32-A1	1 1/4"
AF36SPH-40-A1	1 1/2"
AF36SPH-50-A1	2"
AF36SPH-65-A1	2 1/2"
AF36SPH-80-A1	3"
AF36SPH-100-A1	4"



PART NUMBER	TAB'E' 316 S/S FLANGE AS2129 x PTFE HOSETAIL
AF36SPH-25-E	1"
AF36SPH-32-E	1 1/4"
AF36SPH-40-E	1 1/2"
AF36SPH-50-E	2"
AF36SPH-65-E	2 1/2"
AF36SPH-80-E	3"
AF36SPH-100-E	4"



PART NUMBER	ANSI 150 lb 316 S/S FLOATING FLANGE ASME B16.5 x PTFE HOSETAIL
AF46SPH-25-A1	1"
AF46SPH-32-A1	1 1/4"
AF46SPH-40-A1	1 1/2"
AF46SPH-50-A1	2"
AF46SPH-65-A1	2 1/2"
AF46SPH-80-A1	3"
AF46SPH-100-A1	4"



PART NUMBER	TAB'E' 316 S/S FLOATING FLANGE AS2129 x PTFE HOSETAIL
AF46SPH-25-E	1"
AF46SPH-32-E	1 1/4"
AF46SPH-40-E	1 1/2"
AF46SPH-50-E	2"
AF46SPH-65-E	2 1/2"
AF46SPH-80-E	3"
AF46SPH-100-E	4"

**Specialised Encapsulated Fittings
Available on request.**



Hygienic Fittings



PART NUMBER	BSM 316 S/S STANDARD LINER x HEX NUT x PTFE HOSETAIL
FBSM6SPH-16	1"
FBSM6SPH-24	1 1/2"
FBSM6SPH-32	2"
FBSM6SPH-40	2 1/2"
FBSM6SPH-48	3"
FBSM6SPH-64	4"

PART NUMBER	BSM 316 S/S FLAT FACE LINER (CIP) x HEX NUT x PTFE HOSETAIL
FBSMFF6SPH-16	1"
FBSMFF6SPH-24	1 1/2"
FBSMFF6SPH-32	2"
FBSMFF6SPH-40	2 1/2"
FBSMFF6SPH-48	3"
FBSMFF6SPH-64	4"



PART NUMBER	BSM 316 S/S STANDARD MALE x PTFE HOSETAIL
MBSM6SPH-16	1"
MBSM6SPH-24	1 1/2"
MBSM6SPH-32	2"
MBSM6SPH-40	2 1/2"
MBSM6SPH-48	3"
MBSM6SPH-64	4"

PART NUMBER	BSM 316 S/S FLAT FACE MALE (CIP) x PTFE HOSETAIL
MBSMFF6SPH-16	1"
MBSMFF6SPH-24	1 1/2"
MBSMFF6SPH-32	2"
MBSMFF6SPH-40	2 1/2"
MBSMFF6SPH-48	3"
MBSMFF6SPH-64	4"

**Specialised Encapsulated Fittings
Available on request.**



Hygienic Fittings



PART NUMBER	TRICLOVER 316 S/S FERRULE (STANDARD)
TRI6S-08	1/2"
TRI6S-12	3/4"
TRI6S-16	1"
TRI6S-20	1 1/4"
TRI6S-24	1 1/2"
TRI6S-32	2"
TRI6S-40	2 1/2"
TRI6S-48	3"
TRI6S-64	4"
TRI6S-96	6"



PART NUMBER	TRICLOVER 316 S/S FERRULE x HYGIENIC HOSETAIL
TRI6SFH-08	1/2"
TRI6SFH-12	3/4"
TRI6SFH-16	1"
TRI6SFH-20	1 1/4"
TRI6SFH-24	1 1/2"
TRI6SFH-32	2"
TRI6SFH-40	2 1/2"
TRI6SFH-48	3"
TRI6SFH-64	4"
TRI6SFH-96	6"

*Refer to Technical Data Section for Specifications - Page 355



PART NUMBER	TRICLOVER S/S 304 CLAMP
CLAMP4S-TRI-08	1/2"
CLAMP4S-TRI-12	3/4"
CLAMP4S-TRI-16	1"
CLAMP4S-TRI-20	1 1/4"
CLAMP4S-TRI-24	1 1/2"
CLAMP4S-TRI-32	2"
CLAMP4S-TRI-40	2 1/2"
CLAMP4S-TRI-48	3"
CLAMP4S-TRI-64	4"
CLAMP4S-TRI-96	6"



PART NUMBER	PTFE TRICLOVER SEAL
OR-T-TRI-08	1/2"
OR-T-TRI-12	3/4"
OR-T-TRI-16	1"
OR-T-TRI-20	1 1/4"
OR-T-TRI-24	1 1/2"
OR-T-TRI-32	2"
OR-T-TRI-40	2 1/2"
OR-T-TRI-48	3"
OR-T-TRI-64	4"
OR-T-TRI-96	6"

Specialised Encapsulated Fittings Available on request.



Hygienic Fittings



PART NUMBER	BSM 316 S/S STANDARD LINER
LS6S-16-BM	1"
LS6S-24-BM	1 1/2"
LS6S-32-BM	2"
LS6S-40-BM	2 1/2"
LS6S-48-BM	3"
LS6S-64-BM	4"
LS6S-96-BM	6"
LS6S-128-BM	8"

PART NUMBER	BSM 316 S/S FLAT FACE LINER (CIP)
LFF6S-16-BM	1"
LFF6S-24-BM	1 1/2"
LFF6S-32-BM	2"
LFF6S-40-BM	2 1/2"
LFF6S-48-BM	3"
LFF6S-64-BM	4"
LFF6S-96-BM	6"
LFF6S-128-BM	8"



PART NUMBER	BSM 316 S/S STANDARD MALE
MS6S-16-BM	1"
MS6S-24-BM	1 1/2"
MS6S-32-BM	2"
MS6S-40-BM	2 1/2"
MS6S-48-BM	3"
MS6S-64-BM	4"
MS6S-96-BM	6"
MS6S-128-BM	8"

PART NUMBER	BSM 316 S/S FLAT FACE MALE (CIP)
MFF6S-16-BM	1"
MFF6S-24-BM	1 1/2"
MFF6S-32-BM	2"
MFF6S-40-BM	2 1/2"
MFF6S-48-BM	3"
MFF6S-64-BM	4"
MFF6S-96-BM	6"
MFF6S-128-BM	8"

Specialised Encapsulated Fittings Available on request.



Hygienic Fittings



PART NUMBER	BSM 304 S/S HEX NUT
HN4S-16-BM	1"
HN4S-24-BM	1 1/2"
HN4S-32-BM	2"
HN4S-40-BM	2 1/2"
HN4S-48-BM	3"
HN4S-64-BM	4"
HN4S-96-BM	6"
HN4S-128-BM	8"



PART NUMBER	EPDM BSM 'O' RING SEAL FLAT FACE SEAL (CIP)
BSM-EPDM-FF-16	1"
BSM-EPDM-FF-24	1 1/2"
BSM-EPDM-FF-32	2"
BSM-EPDM-FF-40	2 1/2"
BSM-EPDM-FF-48	3"
BSM-EPDM-FF-64	4"
BSM-EPDM-FF-96	6"
BSM-EPDM-FF-128	8"

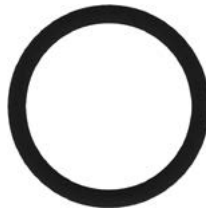

PART NUMBER	EPDM BSM 'O' RING SEAL STANDARD SEAL
BSM-EPDM-16	1"
BSM-EPDM-24	1 1/2"
BSM-EPDM-32	2"
BSM-EPDM-40	2 1/2"
BSM-EPDM-48	3"
BSM-EPDM-64	4"
BSM-EPDM-96	6"
BSM-EPDM-128	8"

Hygienic Fittings



PART NUMBER	BSM 316 S/S STANDARD LINER x HEX NUT x HYGIENIC HOSETAIL
FBSM6SFH-16	1"
FBSM6SFH-24	1 1/2"
FBSM6SFH-32	2"
FBSM6SFH-40	2 1/2"
FBSM6SFH-48	3"
FBSM6SFH-64	4"
FBSM6SFH-96	6"
FBSM6SFH-128	8"

PART NUMBER	BSM 316 S/S FLAT FACE LINER (CIP) x HEX NUT x HYGIENIC HOSETAIL
FBSMFF6SFH-16	1"
FBSMFF6SFH-24	1 1/2"
FBSMFF6SFH-32	2"
FBSMFF6SFH-40	2 1/2"
FBSMFF6SFH-48	3"
FBSMFF6SFH-64	4"
FBSMFF6SFH-96	6"
FBSMFF6SFH-128	8"



PART NUMBER	BSM 316 S/S STANDARD MALE x HYGIENIC HOSETAIL
MBSM6SFH-16	1"
MBSM6SFH-24	1 1/2"
MBSM6SFH-32	2"
MBSM6SFH-40	2 1/2"
MBSM6SFH-48	3"
MBSM6SFH-64	4"
MBSM6SFH-96	6"
MBSM6SFH-128	8"

PART NUMBER	BSM 316 S/S FLAT FACE MALE (CIP) x HYGIENIC HOSETAIL
MBSMFF6SFH-16	1"
MBSMFF6SFH-24	1 1/2"
MBSMFF6SFH-32	2"
MBSMFF6SFH-40	2 1/2"
MBSMFF6SFH-48	3"
MBSMFF6SFH-64	4"
MBSMFF6SFH-96	6"
MBSMFF6SFH-128	8"

**Specialised Encapsulated Fittings
Available on request.**



Hygienic Fittings



PART NUMBER	HYGIENIC 316 S/S LIFESAVER TAIL
LT6SFH-12	3/4"
LT6SFH-16	1"
LT6SFH-20	1 1/4"
LT6SFH-24	1 1/2"
LT6SFH-32	2"
LT6SFH-40	2 1/2"
LT6SFH-48	3"
LT6SFH-64	4"
LT6SFH-80	5"
LT6SFH-96	6"



PART NUMBER	HYGIENIC 316 S/S FERRULE
FF6S-08	1/2"
FF6S-10	5/8"
FF6S-12	3/4"
FF6S-16	1"
FF6S-20	1 1/4"
FF6S-24	1 1/2"
FF6S-32	2"
FF6S-40	2 1/2"
FF6S-48	3"
FF6S-64	4"
FF6S-80	5"
FF6S-96	6"

Bitumen Fittings



BITUMEN FITTINGS

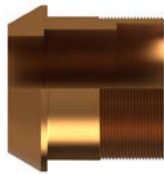

PART NUMBER	BITUMEN LOCKING CONE EXTERNAL THREAD
ALUMINIUM	
BIT-A-LCX-40	3"
BRONZE	
BIT-B-LCX-40	3"



PART NUMBER	BITUMEN LOCKING CONE INTERNAL THREAD
ALUMINIUM	
BIT-A-LCI-40	2 1/2"
BRONZE	
BIT-B-LCI-40	2 1/2"



PART NUMBER	BITUMEN GLAND
ALUMINIUM	
BIT-A-G-40	2 1/2"
BRONZE	
BIT-B-G-40	2 1/2"



PART NUMBER	BITUMEN SWIVEL NUT
ALUMINIUM	
BIT-A-SN-40	2 1/2"
BRONZE	
BIT-B-SN-40	2 1/2"

Bitumen Fittings



BITUMEN FITTINGS



PART NUMBER	BITUMEN BRONZE FERRULE
BIT-B-F-40	2 1/2"



PART NUMBER	BITUMEN FIXED COUPLING
ALUMINIUM	
BIT-A-FC-40	2 1/2"
BRONZE	
BIT-B-FC-40	2 1/2"



PART NUMBER	BITUMEN DUST PLUG
ALUMINIUM	
BIT-A-DP-40	2 1/2"
BRONZE	
BIT-B-DP-40	2 1/2"



PART NUMBER	BITUMEN DUST CAP
ALUMINIUM	
BIT-A-DC-40	2 1/2"
BRONZE	
BIT-B-DC-40	2 1/2"

Pipe Flanges (AS2129)

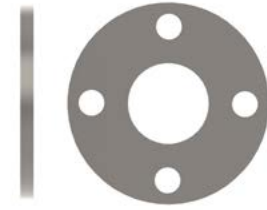

PART NUMBER	TAB 'D' 316 S/S S.O.W. PIPE FLANGE AS2129
AF36SP-12-D	1/2"
AF36SP-20-D	3/4"
AF36SP-25-D	1"
AF36SP-32-D	1 1/4"
AF36SP-40-D	1 1/2"
AF36SP-50-D	2"
AF36SP-65-D	2 1/2"
AF36SP-80-D	3"
AF36SP-100-D	4"
AF36SP-125-D	5"
AF36SP-150-D	6"
AF36SP-200-D	8"
AF36SP-250-D	10"
AF36SP-300-D	12"
AF36SP-350-D	14"
AF36SP-400-D	16"
AF36SP-450-D	18"
AF36SP-500-D	20"
AF36SP-600-D	24"

PART NUMBER	TAB 'E' 316 S/S S.O.W. PIPE FLANGE AS2129
AF36SP-12-E	1/2"
AF36SP-20-E	3/4"
AF36SP-25-E	1"
AF36SP-32-E	1 1/4"
AF36SP-40-E	1 1/2"
AF36SP-50-E	2"
AF36SP-65-E	2 1/2"
AF36SP-80-E	3"
AF36SP-100-E	4"
AF36SP-125-E	5"
AF36SP-150-E	6"
AF36SP-200-E	8"
AF36SP-250-E	10"
AF36SP-300-E	12"
AF36SP-350-E	14"
AF36SP-400-E	16"
AF36SP-450-E	18"
AF36SP-500-E	20"
AF36SP-600-E	24"

Pipe Flanges (AS2129)

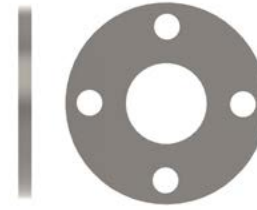
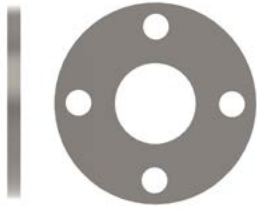

PART NUMBER	TAB 'F' 316 S/S S.O.W. PIPE FLANGE AS2129
AF36SP-12-F	1/2"
AF36SP-20-F	3/4"
AF36SP-25-F	1"
AF36SP-32-F	1 1/4"
AF36SP-40-F	1 1/2"
AF36SP-50-F	2"
AF36SP-65-F	2 1/2"
AF36SP-80-F	3"
AF36SP-100-F	4"
AF36SP-125-F	5"
AF36SP-150-F	6"
AF36SP-200-F	8"
AF36SP-250-F	10"
AF36SP-300-F	12"
AF36SP-350-F	14"
AF36SP-400-F	16"
AF36SP-450-F	18"
AF36SP-500-F	20"
AF36SP-600-F	24"

PART NUMBER	TAB 'H' 316 S/S S.O.W. PIPE FLANGE AS2129
AF36SP-12-H	1/2"
AF36SP-20-H	3/4"
AF36SP-25-H	1"
AF36SP-32-H	1 1/4"
AF36SP-40-H	1 1/2"
AF36SP-50-H	2"
AF36SP-65-H	2 1/2"
AF36SP-80-H	3"
AF36SP-100-H	4"
AF36SP-125-H	5"
AF36SP-150-H	6"
AF36SP-200-H	8"
AF36SP-250-H	10"
AF36SP-300-H	12"
AF36SP-350-H	14"
AF36SP-400-H	16"
AF36SP-450-H	18"
AF36SP-500-H	20"
AF36SP-600-H	24"

Pipe Flanges (ASME B16.5)

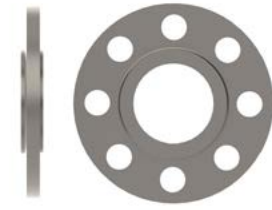
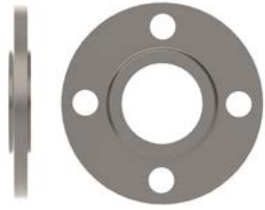

PART NUMBER	ANSI 150 lb 316 S/S S.O.W. PIPE FLANGE ASME B16.5
AF36SP-12-A1	1/2"
AF36SP-20-A1	3/4"
AF36SP-25-A1	1"
AF36SP-32-A1	1 1/4"
AF36SP-40-A1	1 1/2"
AF36SP-50-A1	2"
AF36SP-65-A1	2 1/2"
AF36SP-80-A1	3"
AF36SP-100-A1	4"
AF36SP-125-A1	5"
AF36SP-150-A1	6"
AF36SP-200-A1	8"
AF36SP-250-A1	10"
AF36SP-300-A1	12"
AF36SP-350-A1	14"
AF36SP-400-A1	16"
AF36SP-450-A1	18"
AF36SP-500-A1	20"
AF36SP-600-A1	24"

PART NUMBER	ANSI 300 lb 316 S/S S.O.W. PIPE FLANGE ASME B16.5
AF36SP-12-A3	1/2"
AF36SP-20-A3	3/4"
AF36SP-25-A3	1"
AF36SP-32-A3	1 1/4"
AF36SP-40-A3	1 1/2"
AF36SP-50-A3	2"
AF36SP-65-A3	2 1/2"
AF36SP-80-A3	3"
AF36SP-100-A3	4"
AF36SP-125-A3	5"
AF36SP-150-A3	6"
AF36SP-200-A3	8"
AF36SP-250-A3	10"
AF36SP-300-A3	12"
AF36SP-350-A3	14"
AF36SP-400-A3	16"
AF36SP-450-A3	18"
AF36SP-500-A3	20"
AF36SP-600-A3	24"

Pipe Flanges (ASME B16.5)

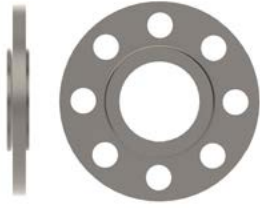

PART NUMBER	ANSI 600 lb 316 S/S S.O.W. PIPE FLANGE ASME B16.5
AF36SP-12-A6	1/2"
AF36SP-20-A6	3/4"
AF36SP-25-A6	1"
AF36SP-32-A6	1 1/4"
AF36SP-40-A6	1 1/2"
AF36SP-50-A6	2"
AF36SP-65-A6	2 1/2"
AF36SP-80-A6	3"
AF36SP-100-A6	4"
AF36SP-125-A6	5"
AF36SP-150-A6	6"
AF36SP-200-A6	8"
AF36SP-250-A6	10"
AF36SP-300-A6	12"
AF36SP-350-A6	14"
AF36SP-400-A6	16"
AF36SP-450-A6	18"
AF36SP-500-A6	20"
AF36SP-600-A6	24"

Pipe Flanges (EN 1092-1)

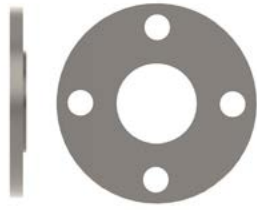

PART NUMBER	DIN 6 316 S/S S.O.W. PIPE FLANGE EN 1092-1
AF36SP-12-D6	1/2"
AF36SP-20-D6	3/4"
AF36SP-25-D6	1"
AF36SP-32-D6	1 1/4"
AF36SP-40-D6	1 1/2"
AF36SP-50-D6	2"
AF36SP-65-D6	2 1/2"
AF36SP-80-D6	3"
AF36SP-100-D6	4"
AF36SP-125-D6	5"
AF36SP-150-D6	6"
AF36SP-200-D6	8"
AF36SP-250-D6	10"
AF36SP-300-D6	12"
AF36SP-350-D6	14"
AF36SP-400-D6	16"
AF36SP-450-D6	18"
AF36SP-500-D6	20"
AF36SP-600-D6	24"

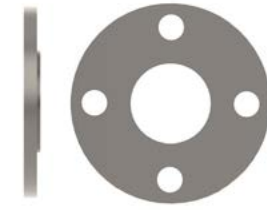

PART NUMBER	DIN 10 316 S/S S.O.W. PIPE FLANGE EN 1092-1
Use DIN 16 for sizes below 200mm	
AF36SP-250-D10	10"
AF36SP-300-D10	12"
AF36SP-350-D10	14"
AF36SP-400-D10	16"
AF36SP-450-D10	18"
AF36SP-500-D10	20"
AF36SP-600-D10	24"

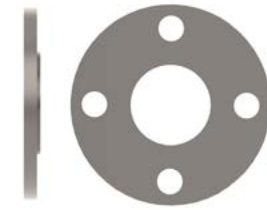

PART NUMBER	DIN 16 316 S/S S.O.W. PIPE FLANGE EN 1092-1
AF36SP-12-D16	1/2"
AF36SP-20-D16	3/4"
AF36SP-25-D16	1"
AF36SP-32-D16	1 1/4"
AF36SP-40-D16	1 1/2"
AF36SP-50-D16	2"
AF36SP-65-D16	2 1/2"
AF36SP-80-D16	3"
AF36SP-100-D16	4"
AF36SP-125-D16	5"
AF36SP-150-D16	6"
AF36SP-200-D16	8"
AF36SP-250-D16	10"
AF36SP-300-D16	12"
AF36SP-350-D16	14"
AF36SP-400-D16	16"
AF36SP-450-D16	18"
AF36SP-500-D16	20"
AF36SP-600-D16	24"

Pipe Flanges (EN 1092-1)

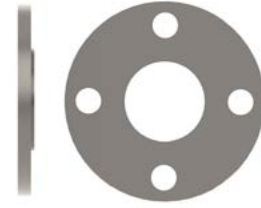
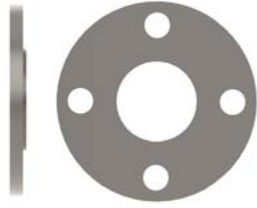

PART NUMBER	DIN 25 316 S/S S.O.W. PIPE FLANGE EN 1092-1
Use DIN 40 for sizes below 200mm	
AF36SP-250-D25	10"
AF36SP-300-D25	12"
AF36SP-350-D25	14"
AF36SP-400-D25	16"
AF36SP-450-D25	18"
AF36SP-500-D25	20"
AF36SP-600-D25	24"

PART NUMBER	DIN 40 316 S/S S.O.W. PIPE FLANGE EN 1092-1
AF36SP-12-D40	1/2"
AF36SP-20-D40	3/4"
AF36SP-25-D40	1"
AF36SP-32-D40	1 1/4"
AF36SP-40-D40	1 1/2"
AF36SP-50-D40	2"
AF36SP-65-D40	2 1/2"
AF36SP-80-D40	3"
AF36SP-100-D40	4"
AF36SP-125-D40	5"
AF36SP-150-D40	6"
AF36SP-200-D40	8"
AF36SP-250-D40	10"
AF36SP-300-D40	12"
AF36SP-350-D40	14"
AF36SP-400-D40	16"
AF36SP-450-D40	18"
AF36SP-500-D40	20"
AF36SP-600-D40	24"

Breakaway, Emergency Release and Dry Break Couplers

INTRODUCTION

Product Overview: Breakaway Couplings, Dry Break Couplings and Emergency Release Couplings

Page 230



MAINTENANCE & SERVICING

Spares Kits and Repairs

Page 231



MARINE RANGE

Size : 1/2" - 8"

Material : 316 Stainless Steel & Aluminium

Page 232



INDUSTRIAL RANGE

Size : 1/2" - 12"

Material : 316 Stainless Steel

Page 234



CRYOGENIC RANGE

Size : 1/2" to 10"

Material : 316 Stainless Steel

Page 234

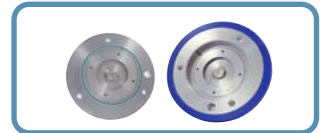

Breakaway, Emergency Release and Dry Break Couplers

Product Overview:

Breakaway Couplings:

Breakaway Couplings have breakstuds that hold the two halves of the coupling together. Its purpose is to resist external loads and line pressure up to a pre-determined point. The Coupling then activates when subjected to forces higher than the breakload setting. The Breakaway Coupling range offers a safe and identifiable parting point within the transfer system and will stop flow in an emergency such as a drive-off or other strain on the transfer system.

Materials: Stainless Steel, Carbon, C276, Titanium, Alloy 20 (not all materials can be offered on the entire range)

Size: 1-1/2" - 12" (not all sizes can be offered on the entire range)

Applications: Industrial, Cryogenic and Marine

Breakload: 15KN - 160KN (Breakload varies on each range)

Breakaway Coupling Range:

- Marine 2 Breakaway Couplings
- Marine Breakaway Couplings
- Industrial Breakaway Couplings
- TTMA Breakaway Couplings
- Non-cloure Breakaway Couplings



Dry Disconnect Couplings:

Connects and disconnects transfer lines with no spillage. Valves open and close automatically on connection and disconnection. This reduces the possibility of human error in transfer operations and reduces spillages to virtually zero.

Materials: Stainless Steel, Aluminium

Size: 1/2" - 8"

Applications: Liquid, Dry Gas, Cryogenic

Handle options: Round, Square Grip, Knurled Grip, Double Square (Red, Blue and polished Stainless Steel)

Standards: Fully compliant to NATO/STANAG 3756, ISO 18683, ISO 21593

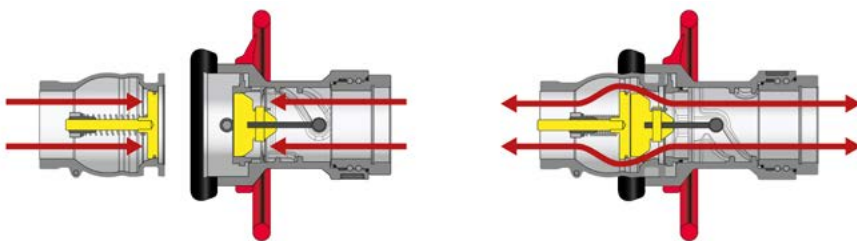

Emergency Release Couplings (ERC):

Emergency Release Couplings offer a release collar mechanism that resists operating loads via a cable or hydraulic system. A Dual release system utilising both cable and hydraulic methods is also an option. The Emergency Release System can be designed to your specific needs. In an emergency, the valves close and the ERC separates. This shuts off the downstream and upstream flows of media within the transfer system.

Materials: Stainless Steel, Aluminium, C276, Carbon Steel

Size: 1" - 10"

Applications: Industrial, Marine and Cryogenic

Breakaway Type: Cable, Hydraulic, Dual Release, Controlled Hydraulic Closure, Spring Retained, High Performance



Breakaway, Emergency Release and Dry Break Couplers

Maintenance:

Installation Operations Maintenance:

To ensure that the unit performs at its optimum level, we advise that the Installation and Operational Guidelines detailed in the IOM Manual(Installation Operations Maintenance) is read and followed.

On request we can add your coupling to our Asset Management Register (HMS) to send you maintenance reminders.

Service /Spares Kit:

We recommend servicing all couplings at least annually. Service/Spares Kits can be purchased to carry out maintenance and servicing. If you require a service/spares kit all we require is the serial number marked on the coupling. This will enable us to identify the component and its settings. The below image show the typical location of Serial/Reference Numbers:



Refurbishment:

Breakaway couplings will be inspected at our facility and a quotation will then be provided detailing approximate costs and time to complete the work. As standard, the coupling will be refurbished and tested by factory trained technicians.



Breakaway, Emergency Release and Dry Break Couplers - Marine

Marine Coupling Range:

MARINE

BREAKAWAY // COUPLINGS

MARINE2 BREAKAWAY

Size : 4"
Material : Stainless Steel

Page 233



MARINE BREAKAWAY

Size : 3" - 8"
Material : Stainless Steel

Page 233



DRY DISCONNECT HOSE UNIT

Size : 1/2" to 8"
Material : Stainless Steel, Aluminium

Page 233



DRY DISCONNECT TANK UNIT

Size : 1/2" - 8"
Material : Stainless Steel, Aluminium

Page 233



KLAWZERO FULLBORE MARINE BREAKAWAY

Size : 4" - 8"
Material : Stainless Steel & Aluminium

Page 234

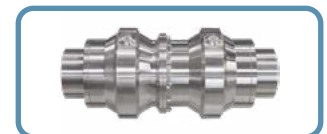

EMERGENCY RELEASE COUPLING

Size : 1" - 10"
Material : Carbon Steel, Stainless Steel

Page 234



QUICK CONNECT FLANGE

Size : 8" - 24"
Material : Forged Steel ASTM 105, Stainless Steel

Page 234



Breakaway, Emergency Release and Dry Break Couplers - Marine



MARINE2 BREAKAWAY COUPLING

Designed to limit stress and fatigue on hoses, especially when wound on hose reels. The Marine2 Breakaway Coupling is 32% shorter and 25% lighter than alternatives.

Sizes: 4"

Housing Material Options: Stainless Steel

Body and Seat Seal Options: Viton, Nitrile, EPDM, Chemraz, Kalrez

End Connections: ANSI 150/300lb, BSPP, BSPT, NPT, Hammer Fig 50/100/200 (MxF)

Break Load: 30KN to 80KN

Breakstud Materials: Stainless Steel 303, Titanium, Inconel 625

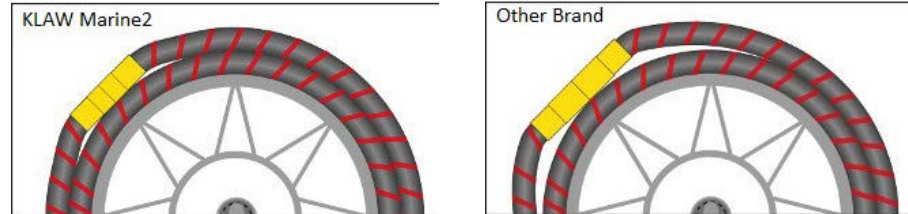

MARINE BREAKAWAY COUPLING



Marine Breakaway Coupling provides an identified and safe parting point within the hose transfer system. When tensile forces exceed predetermined tolerances, the coupling activates.

Sizes: 2 - 8"

Housing Material Options: Stainless Steel

Body and Seat Seal Options: Viton, Nitrile, EPDM, Chemraz, Kalrez, Low Temp. Nitrile

End Connections: ANSI 150/300lb, BSPP, BSPT, NPT, Hammer Fig 50/100/200 (MxF)

Break Load: 20KN to 80KN

Breakstud Materials: Stainless Steel 303, Titanium, Inconel 625

DRY DISCONNECT / DRY BREAK COUPLINGS



HOSE UNIT

The Dry Disconnect automatic valve open and closure design means there is no spillage on connection or disconnection. This prevents costly clean-up costs. These couplings are fully interchangeable with couplings that conform to STANAG 3756.

Size : 1/2" to 8"

Material : Stainless Steel, Aluminium

End Connections: ANSI 150/300lb, PN10, TTMA, PN40, BSPP, BSPT, NPT

Seal Type/Dust Seal Options: Viton, Chemraz, EPDM, GLT, Isolast, Kalrez, Low Temp Nitrile, Nitrile, NBR, Silicon, Neoprene, Cryo PTFE

Handle Options: Round, Square Grip, Knurled Grip, Double Square Grip

Handle Colour: Red, Polished ST/ST, Blue

Plug Options: Rubber, Aluminium,

TANK UNIT

The Dry Disconnect automatic valve open and closure design means there is no spillage on connection or disconnection. This prevents costly clean-up costs. These couplings are fully interchangeable with couplings that conform to STANAG 3756.

Size : 1/2" to 8"

Material : Stainless Steel, Aluminium, Super Duplex, Duplex, C276, Carbon Steel, Hastelloy

End Connections: ANSI 150/300lb, PN10, TTMA, PN40, BSPP, BSPT, NPT

Seal Type/Dust Seal Options: Viton, Chemraz, EPDM, GLT, Isolast, Kalrez, Low Temp Nitrile, Nitrile, NBR, Silicon, Neoprene, Cryo PTFE

Cap Options: Rubber, Aluminium



Breakaway, Emergency Release and Dry Break Couplers - Marine

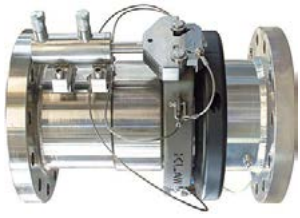

EMERGENCY RELEASE COUPLING (ERC)

Emergency Release Couplings (ERC) and Emergency Release Systems (ERS) minimise risk of spills by closing both downstream and upstream flows of media within the Hose or Loading Arm transfer system. When an event occurs, Flip-Flap Valves close and the Emergency Release Coupling separates. These couplings therefore minimise risk to assets and the environment and help protect personnel from injury. Clean-up costs and downtime are also greatly reduced.

Sizes: 1" - 10"

Pressure: 10 - 40 Bar (depending on size)

Housing Material Options: Stainless Steel, Carbon Steel

Body and Seat Seal Options: Viton, Nitrile, EPDM, Chemraz, Kalrez, Silicon, PTFE, Low Temp Nitrile, Isolast

Breakaway Type: Cable, Hydraulic, High Performance, Dual Release, Spring Retained

End Connections: ANSI 150/300lb, PN 10, 16, 25,40, BSPP, BSPT, NPT, SHD 40 Butt Weld

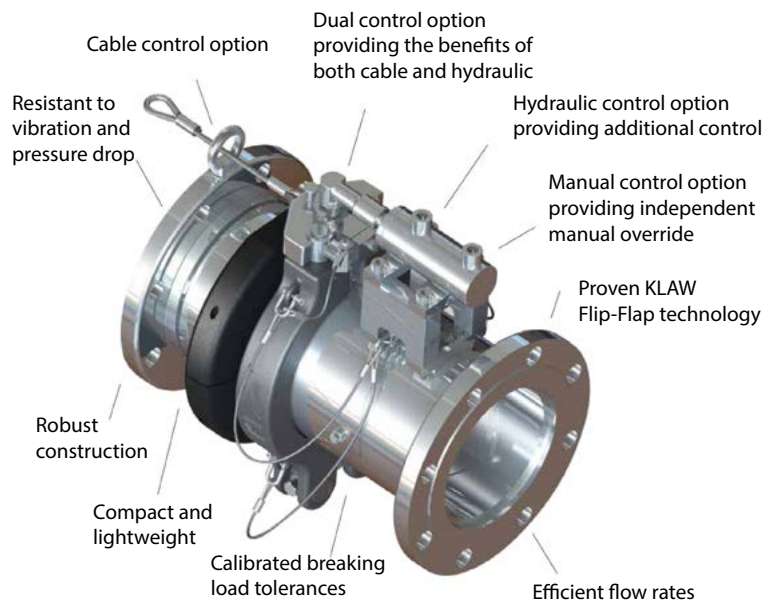

KLAWZERO FULLBORE MARINE BREAKAWAY



The KLAWZERO is the most efficient and robust 100% double course coupling in the Marine Industry. Its full bore design provides full flow with no head loss. Ideal for cuttings fluid, well testing, mud and hydrocarbons in flowback operations.

Size: 4" - 8"

Housing Material Options: Stainless Steel, Aluminium

Internal Material Options: Stainless Steel, Aluminium, Titanium

Body and Seat Seal Options: Viton, Nitrile, EPDM, Chemraz, Kalrez

End Connections: ANSI 150/300lb, BSPP, BSPT, NPT

Breakstud and nut Materials: Stainless Steel 303, Titanium, Inconel 625

KLAWZERO

FLANGE LOCK: QUICK CONNECT FLANGE



The quick connect Flange Lock is up to 50 times faster than traditional flange connections and is ideal for ship terminals wanting cost efficient and safe transfer solutions. No nuts, bolts or gaskets required so vessels can spend less time at berth and that means more ships off-loaded each week – delivering higher profits.

Size: 8" - 24"

Fitment Types: Short Spool Piece, Weld Neck, Studded, Slip-on

End Connections: ASME Class 150, 300, 600, DIN PN10, 16, 25, 40, JIS, etc.

FLANGE LOCK

Breakaway, Emergency Release and Dry Break Couplers - Industrial

Industrial Coupling Range:

FLOW BREAK

THE INDUSTRIAL BREAKAWAY COUPLING

INDUSTRIAL BREAKAWAY COUPLING

Page 236

Size : 1/2" - 12"

Material : Stainless Steel, Aluminium, C276, Carbon Steel, Titanium, Alloy 20



DRY DISCONNECT HOSE UNIT

Page 236

Size : 1" to 8"

Material : Stainless Steel, Aluminium



DRY DISCONNECT TANK UNIT

Page 236

Size : 1" - 8"

Material : Stainless Steel, Aluminium



EMERGENCY RELEASE COUPLING

Page 234

Size : 1" - 10"

Material : Carbon Steel, Stainless Steel



QUICK CONNECT FLANGE

Page 234

Size : 8" - 24"

Material : Forged Steel ASTM 105, Stainless Steel



1 2 3 4 5 6 7 8 9

FITTINGS, FLANGES & COUPLINGS



Safety Breakaway Coupling are suitable for 99% of all liquids and gases.

Breakaway, Emergency Release and Dry Break Couplers - Industrial



FLOW BREAK
THE INDUSTRIAL BREAKAWAY COUPLING

INDUSTRIAL BREAKAWAY COUPLING

In the event of drive-off or extreme pressure surge the Flowbreak activates and delivers 100% instantaneous closure of both upstream and downstream flow. The coupling then separates therefore minimising risk of damage to assets such as loading arms, hoses, mountings and other parts of the transfer system.

Sizes: 1-1/2" - 12"

Housing Material Options: Aluminium, Stainless Steel, Carbon Steel, C276

Body and Seat Seal Options: Encapsulated PTFE, Viton, Nitrile, EPDM, Chemraz, Kalrez, Silicon, Isolast, Cryogenic PTFE, White PTFE

End Connections: ANSI 150/300lb, PN10, PN25, PN40, TTMA, BSPP, BSPT, NPT, SCH40 Butt Weld

Break Load: 15KN to 160KN

Breakstud Materials: Stainless Steel 303/316, Titanium, Inconel 600/686

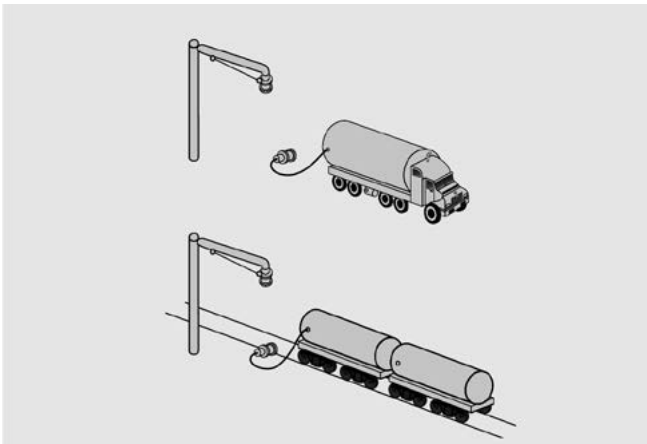

Breakaway Systems prevent spillage, damage to assets and injury to personnel.

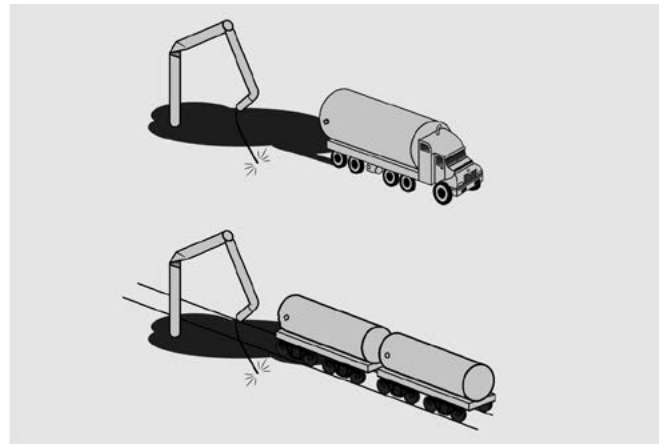

The lack of a Breakaway System in the event of a drive-off can be catastrophic.



DRY DISCONNECT / DRY BREAK COUPLINGS



HOSE UNIT

The Dry Disconnect automatic valve open and closure design means there is no spillage on connection or disconnection. This prevents costly clean-up costs. These couplings are fully interchangeable with couplings that conform to STANAG 3756.

Size : 1/2" to 8"

Material : Stainless Steel, Aluminium

End Connections: ANSI 150/300lb, PN10, TTMA, PN40, BSPP, BSPT, NPT

Seal Type/Dust Seal Options: Viton, Chemraz, EPDM, GLT, Isolast, Kalrez, Low Temp Nitrile, Nitrile, NBR, Silicon, Neoprene, Cryo PTFE

Handle Options: Round, Square Grip, Knurled Grip, Double Square Grip

Handle Colour: Red, Polished ST/ST, Blue

Plug Options: Rubber, Aluminium



TANK UNIT

The Dry Disconnect automatic valve open and closure design means there is no spillage on connection or disconnection. This prevents costly clean-up costs. These couplings are fully interchangeable with couplings that conform to STANAG 3756.

Size : 1" to 8"

Material : Stainless Steel, Aluminium, Super Duplex, Duplex, C276, Carbon Steel, Hastelloy

End Connections: ANSI 150/300lb, PN10, TTMA, PN40, BSPP, BSPT, NPT

Seal Type/Dust Seal Options: Viton, Chemraz, EPDM, GLT, Isolast, Kalrez, Low Temp Nitrile, Nitrile, NBR, Silicon, Neoprene, Cryo PTFE

Cap Options: Rubber, Aluminium

Breakaway, Emergency Release and Dry Break Couplers - Cryogenic

Cryogenic Coupling Range:

CRYO BREAK

THE CRYOGENIC BREAKAWAY COUPLING

CRYOGENIC BREAKAWAY

Size : 1/2" - 4"

Material : Stainless Steel

Page 238



CRYOGENIC DRY DISCONNECT HOSE UNIT

Size : 1" - 8"

Material : Stainless Steel

Page 238



CRYOGENIC DRY DISCONNECT TANK UNIT

Size : 1" - 8"

Material : Stainless Steel

Page 238



CRYOGENIC EMERGENCY RELEASE COUPLING

Size : 1" - 10"

Material : Stainless Steel

Page 239

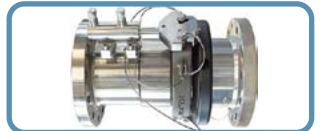

QUICK CONNECT FLANGE

Size : 8" - 24"

Material : Forged Steel ASTM 105, Stainless Steel

Page 234



Breakaway, Emergency Release and Dry Break Couplers - Cryogenic



CRYOGENIC BREAKAWAY COUPLING

The Cryobreak Breakaway Coupling minimises the risk of cryogenic media spills; this reduces the risk of both damage to assets and injury to personnel in the event of a drive-off or extreme pressure flow. It has been designed and manufactured for the safe transfer of media at cryogenic temperatures.

Sizes: 1/2" - 4"

Temperature: -196°C to +70°C

CRYO BREAK
THE CRYOGENIC BREAKAWAY COUPLING

Housing Material Options: Stainless Steel

Sealing Options: Cryo, Viton, Nitrile, EPDM, Low Temp Nitrile, Chemraz, Kalrez, PTFE Isolast, GLT Viton

End Connections: ANSI 150/300lb, PN10, PN25, PN40, TTMA, BSPP, BSPT, NPT, SCH40 Butt Weld

Break Load: 15KN to 60KN

Breakstud Materials: Stainless Steel 316

CRYODC
HOSE AND TANK COUPLINGS

CRYOGENIC DRY DISCONNECT / DRY BREAK COUPLINGS



HOSE UNIT

The CryoDC is simple to use, fast to connect and disconnect, reliable and much safer than traditional flange connections or CGA fittings. Designed and interchangeable to ISO 18683

Size : 1" to 8"

Material : Stainless Steel

End Connections: ANSI 150, NPT Female (other connections available)

Seal: PTFE

Applications: LNG, Cryogenic gas, Bunkering, Tank Storage, Refuelling, Air Separation, Railcards and Trucks, ISO Tanks.



TANK UNIT

The CryoDC is simple to use, fast to connect and disconnect, reliable and much safer than traditional flange connections or CGA fittings. Designed and interchangeable to ISO 18683

Size : 1" to 8"

Material : Stainless Steel

End Connections: ANSI 150, NPT Female (other connections available)

Seal: PTFE

Cap Options: Aluminium (pictured below)



Breakaway, Emergency Release and Dry Break Couplers - Cryogenic



CRYOGENIC EMERGENCY RELEASE COUPLING

Emergency Release Couplings (ERC) minimise risk of spills by closing both downstream and upstream flows of media within the Hose or Loading Arm transfer system. With utilisation of a collar release mechanism rather than the regular breakstud release options the collar release offers a set predetermined activation point before there is any over extension of the attached loading system or hose assembly. The Cryogenic ERC ensuring 100% closure: even in the most demanding of operating conditions.

Temperature: -196°C to +70°C

Housing Material Options: Stainless Steel, Carbon Steel

Seal: Cryogenic PTFE

End Connections: ANSI 150/, NPT Female (other connections available)



LNG Emergency Release Systems

