

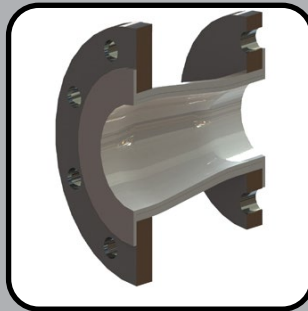

05



**PIPING SYSTEMS / LINED**

## The Range

### LINED SPOOL

Size : 1" to 12"

Profile : Smoothbore

Working Pressure : 1720 to 3160 kPa

Page 194



### LINED 90° ELBOW

Size : 1" to 12"

Profile : Smoothbore

Working Pressure : 1720 to 3160 kPa

Page 195



### LINED 90° 3D ELBOW

Size : 1" to 12"

Profile : Smoothbore

Working Pressure : 1720 to 3160 kPa

Page 190



### LINED 45° ELBOW

Size : 1" to 12"

Profile : Smoothbore

Working Pressure : 1720 to 3160 kPa

Page 197



### LINED 45° 3D ELBOW

Size : 1" to 12"

Profile : Smoothbore

Working Pressure : 1720 to 3160 kPa

Page 198



### LINED TEE

Size : 1" to 12"

Profile : Smoothbore

Working Pressure : 1720 to 3160 kPa

Page 199



### LINED CROSS

Size : 1" to 12"

Profile : Smoothbore

Working Pressure : 1720 to 3160 kPa

Page 200



### LINED CONCENTRIC REDUCER

Size : 1" to 12"

Profile : Smoothbore

Working Pressure : 1720 to 3160 kPa

Page 201

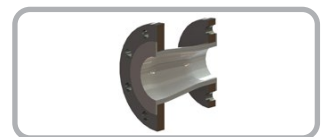

### LINED ECCENTRIC REDUCER

Size : 1" to 12"

Profile : Smoothbore

Working Pressure : 1720 to 3160 kPa

Page 202

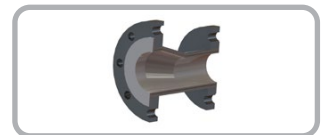

### PIPING SYSTEMS

Size : 1" to 14"

Profile : Smoothbore

Page 203



## Lined Piping Systems - Spool

### Lined Spool

**Construction:** Smoothbore  
**Pipe:** Carbon Steel / Stainless Steel  
(Other specialty metals on request)  
**Liner:** PTFE, PFA, PVDF, PP, FEP, ETFE  
**Size Available:** 1" - 12"  
(Larger sizes upon Request)  
**Vacuum:** Full Vacuum  
**Temperature:** -30°C to 260°C

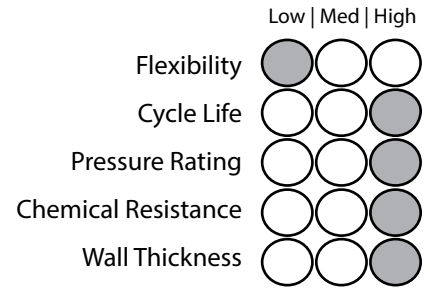

### Construction

**Use:**  
 Our range of products are used in various industries such as Chemicals, Refineries, Pesticides, Petrochemicals, Steel, Food-Processing, Beverages, Alcohols and Acids, Pharmaceuticals, Circuit Breakers, Fertilizers, Desalination.



**Standards:**  
 ASTM F1545, AS4041 Class 1, ASME IX

### Specifications

Part No:	Size	Internal Diameter	Liner Thickness	Flared Dia	At temp(°C)	ANSI class 150	ANSI class 300
	inch	mm	mm	mm	°C	kpa	kpa
TLPa-25-AF3-AF4-b-c	1"	19.50	3.05	50.80	40	1760	3160
TLPa-38-AF3-AF4-b-c	1 1/2"	33.80	3.30	73.00	100	1650	2740
TLPa-50-AF3-AF4-b-c	2"	45.40	3.30	92.10	150	1510	2430
TLPa-80-AF3-AF4-b-c	3"	70.80	3.30	127.00	200	1400	2080
TLPa-100-AF3-AF4-b-c	4"	95.20	3.80	157.20	250	1200	1720
TLPa-150-AF3-AF4-b-c	6"	145.10	4.50	215.90			
TLPa-200-AF3-AF4-b-c	8"	197.40	5.00	269.90			
TLPa-250-AF3-AF4-b-c	10"	249.30	6.00	323.90			
TLPa-300-AF3-AF4-b-c	12"	300.10	6.00	381.00			

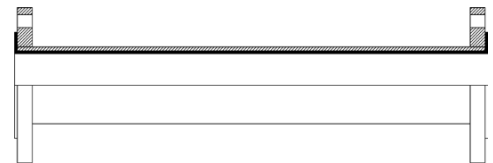

#### Part Number Key:

##### a = Pipe Material

6S = 316 Stainless Steel | 4S = 304 Stainless Steel | MS = Carbon Steel

##### b = 316 Stainless Steel Flange Type

A1 = ANSI 150lb | TE = Table E | TD = Table D | D16 = DIN 16

##### c = Face to Face Length (mm)

### Applications



PIPING SYSTEMS / LINED

## Lined Piping Systems - 90° Elbow

### Lined 90° Elbow

**Construction :** Smoothbore

**Pipe :** Carbon Steel / Stainless Steel  
(Other specialty metals on request)

**Liner:** PTFE, PFA, PVDF, PP, FEP, ETFE

**Size Available :** 1" - 12" (Larger sizes upon Request)

**Vacuum :** Full Vacuum

**Temperature :** -30°C to 260°C

	Low   Med   High
Flexibility	<input checked="" type="radio"/> <input type="radio"/> <input type="radio"/>
Cycle Life	<input type="radio"/> <input type="radio"/> <input checked="" type="radio"/>
Pressure Rating	<input type="radio"/> <input type="radio"/> <input checked="" type="radio"/>
Chemical Resistance	<input type="radio"/> <input type="radio"/> <input checked="" type="radio"/>
Wall Thickness	<input type="radio"/> <input type="radio"/> <input checked="" type="radio"/>

### Construction

**Use:**

Our range of products are used in various industries such as Chemicals, Refineries, Pesticides, Petrochemicals, Steel, Food-Processing, Beverages, Alcohols and Acids, Pharmaceuticals, Circuit Breakers, Fertilizers, Desalination.



**Standards:**

ASTM F1545, AS4041:2006 Class 1, ASME IX:2010

### Specifications

Part Number:	Size	Face to Centre (X)	Liner Thickness	Flared Dia
	inch	mm	mm	mm
TLP90a-25 -AF3-AF3-b	1"	89	3.50	51
TLP90a-38 -AF3-AF3-b	1 1/2"	102	3.50	73
TLP90a-50 -AF3-AF3-b	2"	114	4.30	92
TLP90a-80 -AF3-AF3-b	3"	140	4.40	127
TLP90a-100 -AF3-AF3-b	4"	165	4.40	157
TLP90a-150 -AF3-AF3-b	6"	203	5.50	216
TLP90a-200 -AF3-AF3-b	8"	229	6.00	270
TLP90a-250 -AF3-AF3-b	10"	279	7.50	324
TLP90a-300 -AF3-AF3-b	12"	235	7.50	381

At temp(°C)	ANSI class 150	ANSI class 300
°C	kpa	kpa
40	1760	3160
100	1650	2740
150	1510	2430
200	1400	2080
250	1200	1720

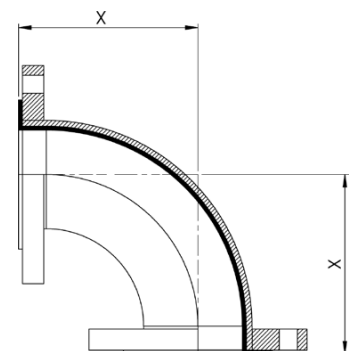

**Part Number Key:**

**a = Pipe Material**

6S = 316 Stainless Steel | 4S = 304 Stainless Steel | MS = Carbon Steel

**b = 316 Stainless Steel Flange Type**

A1 = ANSI 150lb | TE = Table E | TD = Table D | D16 = DIN 16

### Applications





# RUBBER & COMPOSITE HOSE

## Lined Piping Systems - 90° 3D Elbow

### Lined 90° 3D Elbow

**Construction :** Smoothbore  
**Pipe :** Carbon Steel / Stainless Steel  
(Other specialty metals on request)  
**Liner:** PTFE, PFA, PVDF, PP, FEP, ETFE  
**Size Available :** 1" - 12"  
(Larger sizes upon Request)  
**Vacuum :** Full Vacuum  
**Temperature :** -30°C to 260°C

	Low	Med	High
Flexibility	●	○	○
Cycle Life	○	○	●
Pressure Rating	○	○	●
Chemical Resistance	○	○	●
Wall Thickness	○	○	●

### Construction

**Use:**  
 Our range of products are used in various industries such as Chemicals, Refineries, Pesticides, Petrochemicals, Steel, Food-Processing, Beverages, Alcohols and Acids, Pharmaceuticals, Circuit Breakers, Fertilizers, Desalination.



**Standards:**  
 ASTM F1545, AS4041:2006 Class 1, ASME IX:2010

### Specifications

Part Number:	Size	Face to Centre (X)	Internal Diameter	Liner Thickness	Flared Dia
	inch	mm	mm	mm	mm
3DTLP90a-25 -AF3-AF3-b	1"	279	19.50	3.05	50.80
3DTLP90a-38 -AF3-AF3-b	1 1/2"	330	33.80	3.30	73.00
3DTLP90a-50 -AF3-AF3-b	2"	381	45.40	3.30	92.10
3DTLP90a-80 -AF3-AF3-b	3"	533	70.80	3.30	127.00
3DTLP90a-100 -AF3-AF3-b	4"	660	95.20	3.80	157.20

At temp(°C)	ANSI class 150	ANSI class 300
°C	kpa	kpa
40	1760	3160
100	1650	2740
150	1510	2430
200	1400	2080
250	1200	1720

**Part Number Key:**  
**a = Pipe Material**  
 6S = 316 Stainless Steel | 4S = 304 Stainless Steel | MS = Carbon Steel  
**b = 316 Stainless Steel Flange Type**  
 A1 = ANSI 150lb | TE = Table E | TD = Table D | D16 = DIN 16

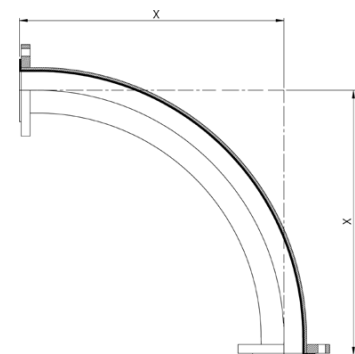

### Applications



## Lined Piping Systems - 45° Elbow

### Lined 45° Elbow

**Construction :** Smoothbore  
**Pipe :** Carbon Steel / Stainless Steel (Other specialty metals on request)  
**Liner:** PTFE, PFA, PVDF, PP, FEP, ETFE  
**Size Available :** 1" - 12" (Larger sizes upon Request)  
**Vacuum :** Full Vacuum  
**Temperature :** -30°C to 260°C

	Low	Med	High
Flexibility	●	○	○
Cycle Life	○	○	●
Pressure Rating	○	○	●
Chemical Resistance	○	○	●
Wall Thickness	○	○	●

### Construction

#### Use:

Our range of products are used in various industries such as Chemicals, Refineries, Pesticides, Petrochemicals, Steel, Food-Processing, Beverages, Alcohols and Acids, Pharmaceuticals, Circuit Breakers, Fertilizers, Desalination.

#### Standards:

ASTM F1545, AS4041:2006 Class 1, ASME IX:2010

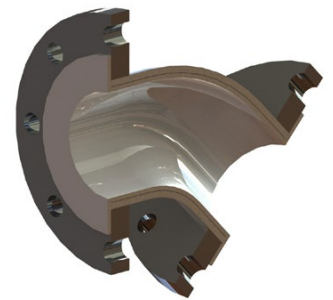

### Specifications

Part Number:	Size	Face to Centre (X)	Liner Thickness	Flared Dia
	inch	mm	mm	mm
TLP45a-25 -AF3-AF3-b	1"	44	3.50	51
TLP45a-38 -AF3-AF3-b	1 1/2"	57	3.50	73
TLP45a-50 -AF3-AF3-b	2"	63	4.30	92
TLP45a-80 -AF3-AF3-b	3"	76	4.40	127
TLP45a-100 -AF3-AF3-b	4"	102	4.40	157
TLP45a-150 -AF3-AF3-b	6"	127	5.50	216
TLP45a-200 -AF3-AF3-b	8"	140	6.00	270
TLP45a-250 -AF3-AF3-b	10"	165	7.50	324
TLP45a-300 -AF3-AF3-b	12"	190	7.50	381

At temp(°C)	ANSI class 150	ANSI class 300
°C	kpa	kpa
40	1760	3160
100	1650	2740
150	1510	2430
200	1400	2080
250	1200	1720

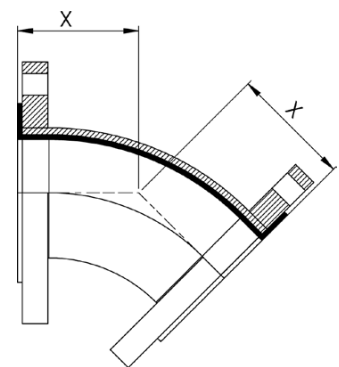

#### Part Number Key:

##### a = Pipe Material

6S = 316 Stainless Steel | 4S = 304 Stainless Steel | MS = Carbon Steel

##### b = 316 Stainless Steel Flange Type

A1 = ANSI 150lb | TE = Table E | TD = Table D | D16 = DIN 16

### Applications







# RUBBER & COMPOSITE HOSE

## Lined Piping Systems - 45° 3D Elbow

### Lined 45° 3D Elbow

**Construction :** Smoothbore

**Pipe :** Carbon Steel / Stainless Steel (Other specialty metals on request)

**Liner:** PTFE, PFA, PVDF, PP, FEP, ETFE

**Size Available :** 1" - 12" (Larger sizes upon Request)

**Vacuum :** Full Vacuum

**Temperature :** -30°C to 260°C

Low | Med | High

Flexibility

Cycle Life

Pressure Rating

Chemical Resistance

Wall Thickness

### Construction

#### Use:

Our range of products are used in various industries such as Chemicals, Refineries, Pesticides, Petrochemicals, Steel, Food-Processing, Beverages, Alcohols and Acids, Pharmaceuticals, Circuit Breakers, Fertilizers, Desalination.



#### Standards:

ASTM F1545, AS4041:2006 Class 1, ASME IX:2010

### Specifications

Part Number:	Size	Face to Centre (X)	Internal Diameter	Liner Thickness	Flared Dia
	inch	mm	mm	mm	mm
3DTLP45a-25 -AF3-AF3-b	1"	203	19.50	3.05	50.80
3DTLP45a-38 -AF3-AF3-b	1 1/2"	229	33.80	3.30	73.00
3DTLP45a-50 -AF3-AF3-b	2"	254	45.40	3.30	92.10
3DTLP45a-80 -AF3-AF3-b	3"	330	70.80	3.30	127.00
3DTLP45a-100-AF3-AF3-b	4"	432	95.20	3.80	157.20

At temp(°C)	ANSI class 150	ANSI class 300
°C	kpa	kpa
40	1760	3160
100	1650	2740
150	1510	2430
200	1400	2080
250	1200	1720

#### Part Number Key:

**a = Pipe Material**

6S = 316 Stainless Steel | 4S = 304 Stainless Steel | MS = Carbon Steel

**b = 316 Stainless Steel Flange Type**

A1 = ANSI 150lb | TE = Table E | TD = Table D | D16 = DIN 16

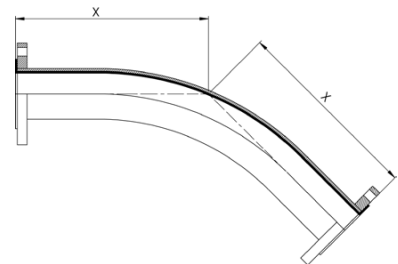

### Applications



1 2 3 4 5 6 7 8 9 PIPING SYSTEMS / LINED

## Lined Piping Systems - Tee

### Lined Tee

**Construction :** Smoothbore  
**Pipe :** Carbon Steel / Stainless Steel (Other specialty metals on request)  
**Liner:** PTFE, PFA, PVDF, PP, FEP, ETFE  
**Size Available :** 1" - 12" (Larger sizes upon Request)  
**Vacuum :** Full Vacuum  
**Temperature :** -30°C to 260°C

	Low   Med   High
Flexibility	● ○ ○
Cycle Life	○ ○ ●
Pressure Rating	○ ○ ●
Chemical Resistance	○ ○ ●
Wall Thickness	○ ○ ●

### Construction

#### Use:

Our range of products are used in various industries such as Chemicals, Refineries, Pesticides, Petrochemicals, Steel, Food-Processing, Beverages, Alcohols and Acids, Pharmaceuticals, Circuit Breakers, Fertilizers, Desalination.

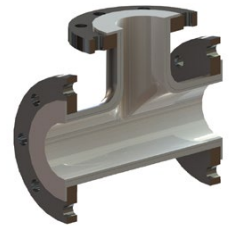

#### Standards:

ASTM F1545, AS4041:2006 Class 1, ASME IX:2010

### Specifications

Part Number:	Size		Face to Centre (X)
	NB1	NB2	mm
TLPTa-25-25-AF3-AF3-b	1"	1"	89
TLPTa-38-38-25-AF3-AF3-b	1 1/2"	1"	102
TLPTa-38-38-AF3-AF3-b	1 1/2"	1 1/2"	102
TLPTa-50-50-AF3-AF3-b	2"	1"	114
TLPTa-50-50-38-AF3-AF3-b	2"	1 1/2"	114
TLPTa-50-50-AF3-AF3-b	2"	2"	114
TLPTa-80-80-38-AF3-AF3-b	3"	1 1/2"	140
TLPTa-80-80-50-AF3-AF3-b	3"	2"	140
TLPTa-80-80-AF3-AF3-b	3"	3"	140
TLPTa-100-100-50-AF3-AF3-b	4"	2"	165
TLPTa-100-100-80-AF3-AF3-b	4"	3"	165
TLPTa-100-100-AF3-AF3-b	4"	4"	165
TLPTa-150-150-80-AF3-AF3-b	6"	3"	203
TLPTa-150-150-100-AF3-AF3-b	6"	4"	203
TLPTa-150-150-AF3-AF3-b	6"	6"	203
TLPTa-200-200-AF3-AF3-b	8"	8"	229

At temp(°C)	ANSI class 150	ANSI class 300
°C	kpa	kpa
40	1760	3160
100	1650	2740
150	1510	2430
200	1400	2080
250	1200	1720

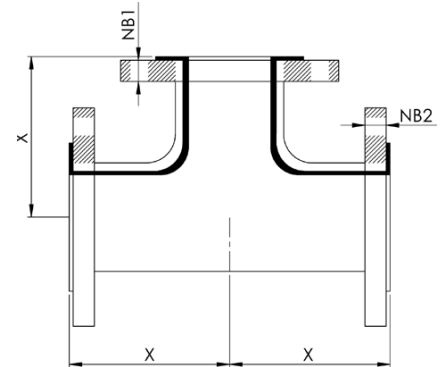

#### Part Number Key:

**a = Pipe Material:** 6S = 316 Stainless Steel | 4S = 304 Stainless Steel | MS = Carbon Steel  
**b = 316 Stainless Steel Flange Type:** A1 = ANSI 150lb | TE = Table E | TD = Table D | D16 = DIN 16

### Applications







# RUBBER & COMPOSITE HOSE

## Lined Piping Systems - Cross

### Lined Cross

**Construction :** Smoothbore

**Pipe :** Carbon Steel / Stainless Steel (Other specialty metals on request)

**Liner:** PTFE, PFA, PVDF, PP, FEP, ETFE

**Size Available :** 1" - 12" (Larger sizes upon Request)

**Vacuum :** Full Vacuum

**Temperature :** -30°C to 260°C

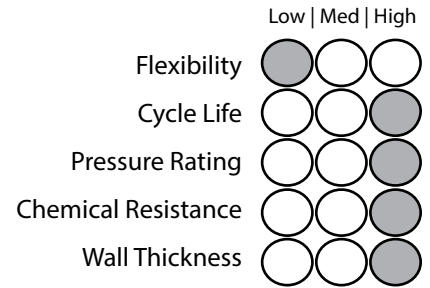

### Construction

**Use:**

Our range of products are used in various industries such as Chemicals, Refineries, Pesticides, Petrochemicals, Steel, Food-Processing, Beverages, Alcohols and Acids, Pharmaceuticals, Circuit Breakers, Fertilizers, Desalination.

**Standards:**

ASTM F1545, AS4041:2006 Class 1, ASME IX:2010

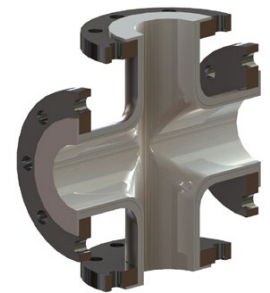

### Specifications

Part Number:	Size	Face to Centre (X)	Liner Thickness	Flared Dia
	inch			
TLPCa-25-AF3-AF3-b	1"	89	3.30	48
TLPCa-38-AF3-AF3-b	1 1/2"	102	3.80	69
TLPCa-50-AF3-AF3-b	2"	114	4.00	88
TLPCa-80-AF3-AF3-b	3"	140	4.00	118
TLPCa-100-AF3-AF3-b	4"	165	4.00	151
TLPCa-150-AF3-AF3-b	6"	203	7.00	204
TLPCa-200-AF3-AF3-b	8"	229	8.00	256
TLPCa-250-AF3-AF3-b	10"	279	8.00	312
TLPCa-300-AF3-AF3-b	12"	305	10.80	376

At temp(°C)	ANSI class 150	ANSI class 300
°C	kpa	kpa
40	1760	3160
100	1650	2740
150	1510	2430
200	1400	2080
250	1200	1720

**Part Number Key:**

**a = Pipe Material**

6S = 316 Stainless Steel | 4S = 304 Stainless Steel | MS = Carbon Steel

**b = 316 Stainless Steel Flange Type**

A1 = ANSI 150lb | TE = Table E | TD = Table D | D16 = DIN 16

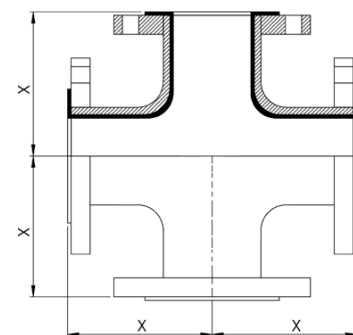

### Applications



## Lined Piping Systems - Concentric Reducer

### Lined Concentric Reducer

**Construction :** Smoothbore

**Pipe :** Carbon Steel / Stainless Steel  
(Other specialty metals on request )

**Liner:** PTFE, PFA, PVDF, PP, FEP, ETFE

**Size Available :** 1/2" - 12"  
(Larger sizes upon Request)

**Vacuum :** Full Vacuum

**Temperature :** -30°C to 260°C

	Low	Med	High
Flexibility	○	○	○
Cycle Life	○	○	○
Pressure Rating	○	○	○
Chemical Resistance	○	○	○
Wall Thickness	○	○	○

#### Construction

##### Use:

Our range of products are used in various industries such as Chemicals, Refineries, Pesticides, Petrochemicals, Steel, Food-Processing, Beverages, Alcohols and Acids, Pharmaceuticals, Circuit Breakers, Fertilizers, Desalination.

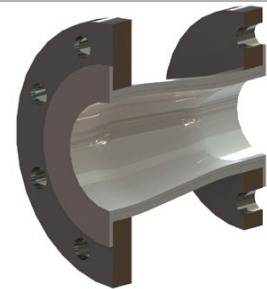

##### Standards:

ASTM F1545, AS4041:2006 Class 1, ASME IX:2010

#### Specifications

Part Number:	Flange Size		Face To Face (X)
	inch	inch	mm
TLPa-CR-25-12-b-b	1"	1/2"	114
TLPa-CR-25-20-b-b	1"	3/4"	114
TLPa-CR-38-25-b-b	1 1/2"	1"	114
TLPa-CR-38-25-b-b	1 1/2"	1"	114
TLPa-CR-50-25-b-b	2"	1"	127
TLPa-CR-50-38-b-b	2"	1 1/2"	127
TLPa-CR-80-38-b-b	3"	1 1/2"	152
TLPa-CR-80-50-b-b	3"	2"	152
TLPa-CR-100-38-b-b	4"	1 1/2"	178
TLPa-CR-100-50-b-b	4"	2"	178
TLPa-CR-100-80-b-b	4"	3"	178
TLPa-CR-150-80-b-b	6"	3"	229
TLPa-CR-150-100-b-b	6"	4"	229
TLPa-CR-200-100-b-b	8"	4"	279
TLPa-CR-250-150-b-b	10"	6"	305

At temp(°C)	ANSI class 150	ANSI class 300
°C	kpa	kpa
40	1760	3160
100	1650	2740
150	1510	2430
200	1400	2080
250	1200	1720

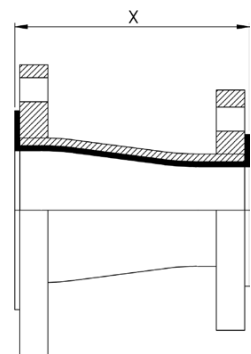

##### Part Number Key:

**a = Pipe Material:** 6S = 316 Stainless Steel | 4S = 304 Stainless Steel | MS = Carbon Steel

**b = 316 Stainless Steel Flange Type:** A1 = ANSI 150lb | TE = Table E | TD = Table D | D16 = DIN 16

#### Applications





# RUBBER & COMPOSITE HOSE

## Lined Piping Systems - Eccentric Reducer

### Lined Eccentric Reducer

**Construction :** Smoothbore

**Pipe :** Carbon Steel / Stainless Steel (Other specialty metals on request)

**Liner:** PTFE, PFA, PVDF, PP, FEP, ETFE

**Size Available :** 1" - 12" (Larger sizes upon Request)

**Vacuum :** Full Vacuum

**Temperature :** -30°C to 260°C

Low | Med | High

Flexibility

Cycle Life

Pressure Rating

Chemical Resistance

Wall Thickness

### Construction

#### Use:

Our range of products are used in various industries such as Chemicals, Refineries, Pesticides, Petrochemicals, Steel, Food-Processing, Beverages, Alcohols and Acids, Pharmaceuticals, Circuit Breakers, Fertilizers, Desalination.

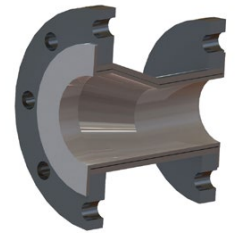

#### Standards:

ASTM F1545, AS4041:2006 Class 1, ASME IX:2010

### Specifications

Part Number:	Flange Size		Face To Face (X)	Eccentricity (E)
	inch	inch	mm	mm
TLPa-ER-38-25-b-b	1 1/2"	1"	114	6
TLPa-ER-50-25-b-b	2"	1"	127	12.2
TLPa-ER-50-38-b-b	2"	1 1/2"	127	6
TLPa-ER-80-25-b-b	3"	1"	152	25
TLPa-ER-80-38-b-b	3"	1 1/2"	152	18.3
TLPa-ER-80-50-b-b	3"	2"	152	14
TLPa-ER-100-50-b-b	4"	2"	178	25
TLPa-ER-100-80-b-b	4"	3"	178	13
TLPa-ER-150-80-b-b	6"	3"	229	35.2
TLPa-ER-150-100-b-b	6"	4"	229	27
TLPa-ER-200-100-b-b	8"	4"	279	46.4
TLPa-ER-200-150-b-b	8"	6"	279	25
TLPa-ER-250-100-b-b	10"	6"	305	52
TLPa-ER-250-200-b-b	10"	8"	305	27
TLPa-ER-300-200-b-b	12"	8"	356	52
TLPa-ER-300-250-b-b	12"	10"	356	25

At temp(°C)	ANSI class 150	ANSI class 300
°C	kpa	kpa
40	1760	3160
100	1650	2740
150	1510	2430
200	1400	2080
250	1200	1720

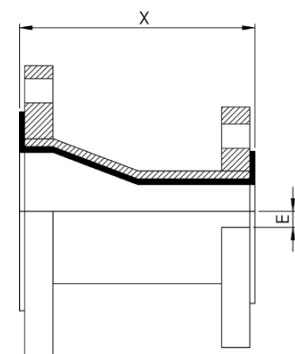

#### Part Number Key:

**a = Pipe Material:** 6S = 316 Stainless Steel | 4S = 304 Stainless Steel | MS = Carbon Steel

**b = 316 Stainless Steel Flange Type:** A1 = ANSI 150lb | TE = Table E | TD = Table D | D16 = DIN 16

### Applications



1 2 3 4 5 6 7 8 9 PIPING SYSTEMS / LINED

## Piping Systems

### Piping Systems

**Construction :** Smoothbore

**Pipe :** Carbon Steel / Stainless Steel (Other specialty metals on request)

**Size Available :** 1" - 14" (Larger sizes upon Request)

**Vacuum :** Full Vacuum

**Temperature :** 900°C

	Low	Med	High
Flexibility			
Cycle Life			
Pressure Rating			
Chemical Resistance			
Wall Thickness			

### Construction

**Use:**

Our range of piping systems are used in various industries such as oil and gas refineries, alumina refineries, chemical process plants, aluminium smelters, tunnels, water treatment plants, food & pharmaceutical plants.

**Welding Standards:**

- AS4041:2006 Class 1
- ASME IX:2010
- ASME B31.3: 2008
- AS/NZS 2992:1998

**Welding Processes:**

- Gas Tungsten Arc Welding (GTAW)
- Metal Inert Gas Welding (MIGW)
- Manual Metal Arc Welding (MMAW)
- Flux Cored Arc Welding (FCAW)

**Piping Standards:**

- ANSI
- ASME
- ISO
- DIN



### Applications

