

Product & Services Catalogue 2024/25 Edition

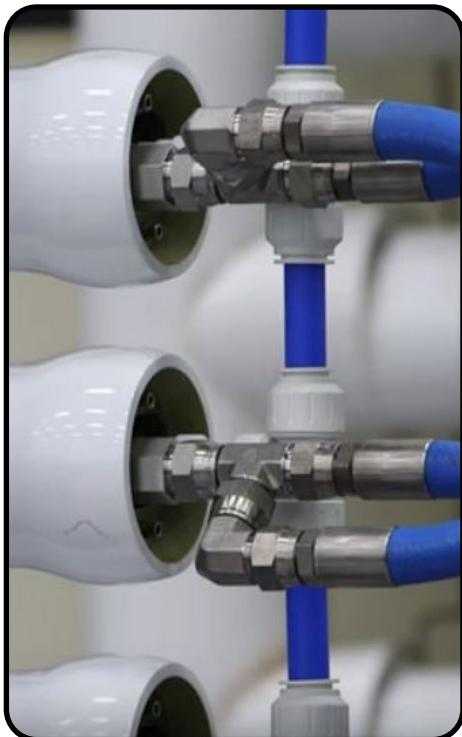

ENGINEERING FLUID TRANSFER PRODUCTS



hoseflex.com

2024/2025 Products & Services Catalog

NEW! **FACTOR** HOW EFFICIENT

NEW! **FACTORS** HOW EFFICIENT

NEW! **FACTORS** HOW EFFICIENT

NEW! **FACTORS** HOW EFFICIENT

NEW! **FACTORS** HOW EFFICIENT

NEW! **FACTORS** HOW EFFICIENT

NEW! **FACTORS** HOW EFFICIENT

NEW! **FACTORS** HOW EFFICIENT

NEW! **FACTORS** HOW EFFICIENT



COMPANY PROFILE

Recognised as an industry leader in engineering fluid transfer products, Pacific Hoseflex Pty Ltd (PHF) is a third generation Australian owned and operated business. PHF have the most advanced technology in their market, with an electronic scheduling and ERP System and a fully digitalised workplace. This system ensures the business keeps up to date with client needs and the emergence of Industry 4.0. in manufacturing.

The modern manufacturing facilities are successfully producing products which are distributed throughout Australia and globally. 6 Sigma techniques are used to ensure processes are carried out in the most efficient manner so clients receive the highest quality product.

The main business focus is to deliver superior quality products and excellent service to meet customer needs across a diverse range of industries. Supported with extensive research and development, highly qualified technicians knowledge and expertise has given the company a competitive advantage when tendering within the industry.

Pacific Hoseflex holds the quality-assured stamp of approval across manufacturing (ISO 9001), Workplace Health and Safety (ISO 45001), and Environmental (ISO 14001) work practices. The capacity to meet the requirements of projects, including engineering design and specification, complements our reputation as a market leader.

Brands:



Certifications:



Locations:

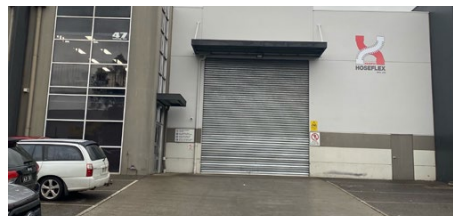

Queensland (Head Office):

10 Alex Fisher Drive,
Burleigh Heads QLD 4220
Phone: +617 5593 4292
www.hoseflex.com
Email: salesqld@hoseflex.com.au

Victoria Branch:

47 Technology Drive, Sunshine
West, VIC 3020
Phone: +613 8566 7250
www.hoseflex.com
Email: salesvic@hoseflex.com.au

Western Australia Branch:

U1, 431 Yangebup Road,
Cockburn Central, WA 6164
Phone: +618 9468 2840
www.hoseflex.com
Email: saleswa@hoseflex.com.au



COMPANY PROFILE

2D/3D CAD Drawings

Technical drawings are created by a qualified draftsman using 2D/3D CAD mechanical design software. Models of parts and assemblies are configured to dimensions and tolerances to suffice accurate manufacture, design and installation. Comprehensive technical support and drawings are available upon request and can be supplied with orders or quotations as required.



Hose/Asset Management System

Pacific Hoseflex has developed and implemented a hose management system to offer clients complete traceability and on site product identification. This can be partnered with our on site testing service in accordance to ISO 9712. Our system is flexible and can be customised to accommodate the specific needs of individual clients.



Oxygen Cleaning

This unique service offered by Pacific Hoseflex for piping systems and components to ensure the product is safe for use in Oxygen service and other critical applications.

- Hoses
- Pipe Work
- Expansion Joints
- Fittings
- Custom Fabrication
- Valves
- Pipe Spools



Testing & Certification

On Site: In accordance with ISO 9712 and ISO/IEC 17025

Test Mediums: Water, Hydraulic Oil, Nitrogen, Hydrogen, Compressed air

Non-Destructive / Destructive Test Methods:

Vacuum, Penetrant Testing, Magnetic Particle, Holiday/Spark Test, Radiographic Testing, Continuity Test, On site Testing (Live video testing Available on Request)

Third Party Inspections: NATA, DNV, Lloyds, CE Certification



Pipe Work & Hose Installation

Pacific Hoseflex has over 20 years experience in fitting, installing and commissioning fluid transfer products. Extensive client consultation and negotiation in relation to each project is conducted to ensure the product installation provides maximum performance and meets client expectations.



Welding Capabilities

Welding Materials: Carbon steel, stainless steel and other high-grade alloys

Welding techniques: Gas Tungsten Arc Welding (GTAW), Metal Inert Gas Welding (MIGW), Manual Metal Arc Welding (MMAW) and Flux Cored Arc Welding (FCAW)

Welding Standards: AS4041 Class 1, ASME B31.3, ASME IX, AS 3992, ASME BPVC.IX & AS/NZS 1554.1 SP



Crimping Capabilities

Pacific Hoseflex's workshops are equipped with crimping machines which offer a range of crimping services from 1/8" brake lines to 400mm dredging & docking hoses. With extensive expertise in assembly of industrial and hydraulic hose techniques, Pacific Hoseflex provides precision and accurate crimping processes using the latest technology.



Laser marking / tagging and traceability

Pacific Hoseflex offers both metallic and non-metallic laser marking identification on all manufactured products. Specific data can be customized on any item or assembly. All manufactured products are laser marked with a unique number that ensures traceability and can be linked back to PHF's in-house Inspection Test Procedure (ITP). Traceability of products conforms to Quality Management System ISO 9001.



SPECIALITY PRODUCTS

01	<p>PTFE Hose</p> 	
02	<p>Vitalflex[®] Stainless Steel Hose</p> 	
03	<p>Expansion Joints</p>	
04	<p>Rubber and Composite Hose</p>  	
05	<p>Piping Systems / Lined</p>	
06	<p>Fittings, Flanges & Couplings</p> 	
07	<p>Swivel Joints</p>	
09	<p>Liners / Covers</p>	
10	<p>Technical Data</p>	

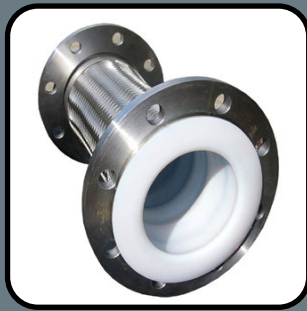

01

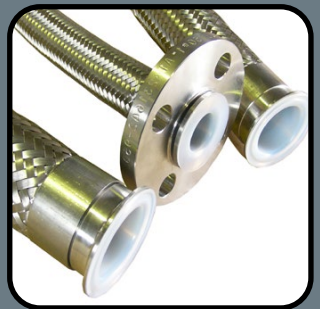
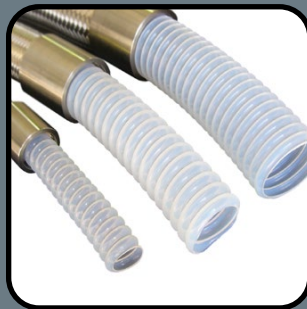

PTFE HOSE

Range

SMOOTHBORE PTFE

Size : 1/8" to 1 1/8"

Working Pressure : 5171 to 20700 kPa

Page 9

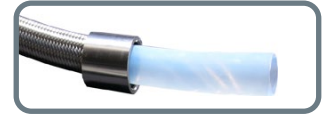

SMOOTHBORE HIGH PRESSURE PTFE

Size : 1/4" to 1 1/8"

Working Pressure : 32,000 kPa

Page 10



ULTRA HIGH SMOOTHBORE PRESSURE PTFE

Size : 1/4" to 1"

Working Pressure : 25000 to 47500 kPa

Page 11



HIGH PRESSURE PTFE THERMOPLASTIC SMOOTHBORE

Size : 1/8" to 13/32" | Working Pressure : 31000 to 55200 kPa

Page 12



TAPE WRAPPED CONVOLUTED PTFE

Size : 3/8" to 4"

Working Pressure : 1000 to 6900 kPa

Page 13

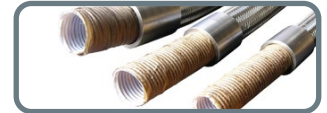

EASYFLEX CONVOLUTED PTFE

Size : 3/8" to 2"

Working Pressure : 2300 to 13800 kPa

Page 14

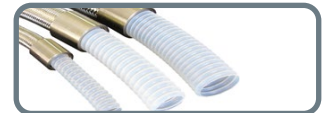

ENCAPSULATED PTFE

Size : 1/4" to 6"

Working Pressure : 500 to 1500 kPa

Page 15



ENCAPSULATED PTFE SS1 METALLIC HOSE

Size : 1/2" to 6"

Working Pressure : 1200 to 6500 kPa

Page 16



SLICKFLEX SMOOTHBORE/CONVOLUTED PTFE

Size : 1/4" to 2"

Working Pressure : 3000 to 8800 kPa

Page 17

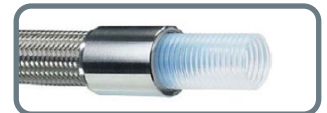

CONPRO PTFE

Size : 1/2" to 3"

Working Pressure : 600 to 1000 kPa

Page 18

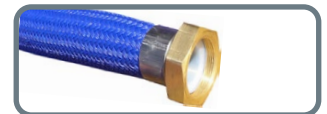

CHLORINE TRANSFER PTFE

Size : 1/2" to 1"

Working Pressure : 2600 to 3400 kPa

Page 19



PTFE ULTRA HIGH PRESSURE GAS CYLINDER HOSE

Size : 1/4"

Working Pressure : 47500 kPa

Page 20



TEFLEX SILICONE JACKET PTFE

Size : 1/4" to 1"

Working Pressure : 6200 to 22500 kPa

Page 21

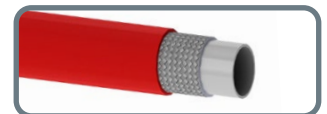

RUBBER FEP LINER

Size : 1/2" to 4"

Working Pressure : 1034 to 3447 kPa

Page 22



PTFE TUBING

Size : Imperial = 1/16" to 1" | Metric = 2mm to 32mm |

Working Pressure : 1034 kPa

Page 23-24



PTFE Hose Design

Introduction

Polytetrafluoroethylene (PTFE) is an engineered fluoropolymer. Outstanding resistance to chemicals is one of its primary attributes. All PTFE products are either post sintered or slow sintered. Post sintered PTFE gives the best overall performance on permeation therefore is better for use with gases. Slow sintered allow for a better level of permeation but not as good as post sintered. Slow sintered PTFE is mainly used for fluids. Post sintered in available in the UHP-PTFE (Ultra High Pressure Smoothbore PTFE) Range. Refer to Page 11.

A broad temperature range of -54°C to 260°C makes this hose material suitable for the majority of fluids and ambient temperature conditions found in most industries. With all types of hose, increased working temperatures require a reduction in maximum rated working or burst pressure. Whenever excessive flexing, vibration, thermal fluctuations or rapid pressure impulsing is in evidence, further caution should be exercised in reducing the maximum working pressure.

An extremely low coefficient of friction (0.05 to 0.20) provides a non-stick surface. Water absorption of PTFE is negligible, less than 0.01% by ASTM test, and it is FDA-approved for food and pharmaceutical use.

Additionally, PTFE will withstand flexing and vibration without failure from flex fatigue. PTFE is chemically inert. It will not break down or deteriorate in service, and it has an unlimited shelf life because properties do not change with age or exposure to weather. PTFE hose can be used in aerospace, automotive, chemical and industrial applications.

Pacific Hoseflex offers PTFE hose in a variety of configurations. PTFE hose innercore is offered in smooth bore, convoluted, smooth inner with a convoluted outer, conductive (Carbon black added) anti-static and non-conductive virgin. Type 304 or 316 stainless steel wire braid is the standard reinforcement with other speciality materials available.

Pacific Hoseflex can offer alternative hose covers for chafe resistance and silicone-covered hose for heat and fire resistance. Alternate braid materials include Nomex braided convoluted hose and Kevlar braided high-pressure smoothbore hose.

All stated burst pressures are static and are measured on samples at ambient temperature from which averages are recorded to create relevant specifications. Proof or test pressures are usually twice working pressure. All burst pressures are conservatively rated to provide a high margin of safety. At working pressure this falls within the range +2% to -4% (1/8" & 3/16" +0% to -6%). Pacific Hoseflex 100% tests all assemblies.

A damaging electrostatic charge can build up inside the hose when electrically resistive fluids are being transmitted at very high flow rates (particularly if the PTFE hose assemblies are lengthy). To prevent this, special carbon is mixed with the PTFE to reduce its resistivity. The need for earth conductor braids or wires in the bore of the hose is therefore eliminated.

Regarding PTFE tubing, PTFE Hose and Hose Assemblies: Please be advised that we have found no instance of the use of bovine or other animal derived materials used in the manufacture of our PTFE braided products. The subject products are 100% animal origin free. Therefore, there is no concern with regard to the BSE/TSE issue in the PTFE tube and hose as defined in specification EMEA 410.01 Rev.2.

Temperature Correction Factor Table

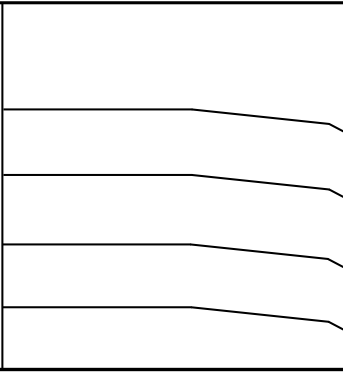
WORKING PRESSURE P.S.I.				% CATALOGUE WORKING PRESSURE THAT MAY BE SAFELY USED			
4000	DO NOT		DO NOT	DEGREES °C			
3000	USE		USE	-60 TO +100	100		
2000	BELOW		ABOVE	+100 TO +150	93		
1000	-60°C			+150 TO +200	85		
				+200 TO +250	77		
			+250 TO +260	70			
DEGREES °C		-60	0	+100	+200	+260	

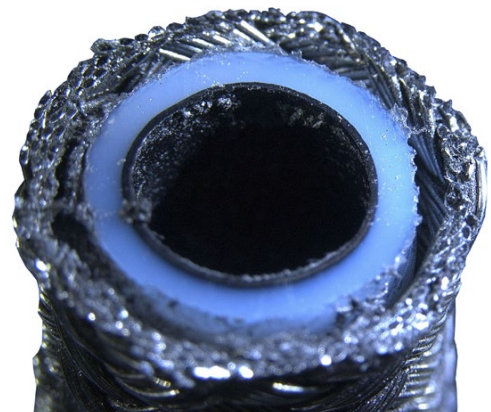

Conductive Hose

Conductive Hose Use

There are general principles we have applied to understand if anti-static (AS) is required or not and this very much depends on the medium passing through the hose.

1. For a single phase medium passing through the hose, AS is usually considered necessary where the medium electrical conductivity is less than 10,000 pS/m (pico Siemens per meter). Note electrical conductivity is not always known and electrical conductivity varies with temperature.
2. For a two (or more) phase medium (e.g. a mixture of gas and liquid (such as wet steam), solid particles and liquid or solid particles and gas) AS IS ALWAYS REQUIRED.
3. Pure clean gases should not require AS.
4. If there is any doubt always use AS. (Often customers do not know the electrical conductivity of the medium passing through the hose)

STATEMENT ON RECOMMENDED FLOW RATES (CONDUCTIVE OR NON-CONDUCTIVE HOSE)

Limiting flow velocities in hoses often relates to electrostatic charging/discharging issues. There are standards for chemical plant equipment (e.g. IEC 60069-32-1) which recommend flow velocities should be less than 7 m/s for low conductivity fluids e.g. fluids which would generate potentially damaging electrostatic charges. Cavitation is likely to be related to this in that a two phase flow would be formed (e.g. gas bubbles in a liquid) and would generate high levels of electrostatic charge. The whole area of electrostatic charging is complex in that a low conductivity fluid can become electrostatically charged as it flows through a pipe or hose.

At the same time the pipe or hose also becomes charged (with the opposite polarity of charge to that in the fluid). As far as hoses go we can supply an AS hose to take care of any charge which tries to build up on the inner surface of the liner (e.g. giving any charge a path to earth) and prevent electrostatic discharges taking place through the hose wall. However normally this does not remove much electrostatic charge from the fluid passing through. Designers of chemical plants are aware of low conductivity fluids becoming charged and are supposed to take this into account when the plant is designed.

As far as hoses are concerned we should recommend an AS hose when we are aware the application needs one e.g. a low conductivity fluid or two phase flow is going to pass through. This will depend on information we obtain from the customer. If they can't supply enough information to make a decision between a natural PTFE liner or AS liner then the default should be to offer an AS liner. Under these circumstances there should be no need to limit the flow velocity in our hoses.



Vacuum Performance

Hose construction determines the 'hoop' strength or the relative ability of the hose to resist collapse. Generally, smaller IDs, thicker walls, external reinforcement such as wire wrap or covers and bonding together the hose layers serve to increase hoop strength. As the temperature of a hose increases, the hoop strength typically decreases because the hose material softens.

As a hose approaches its static bend radius limit, hoop strength can be adversely affected because the hose profile will go from round to oval. If combinations of these factors exist (i.e. large ID, thin wall, high temperature, extreme bending), hoop strength is reduced further.

PTFE hose is a relatively thin walled product and is therefore subject to vacuum collapse if not properly specified and protected. With single braided smooth bore hose, the unbounded metal braid (the pressure handling element of the hose) is of limited value in a vacuum application, especially as temperature increases.

The addition of internal or external springs or bonded covers is the best way to overcome potential vacuum collapse. Certain styles and smaller sizes, smooth bore hoses are rated to 28 Hg at ambient temperature and within specified bend radius.

When vacuum is involved in an application, always determine the expected range of temperature and the potential bending conditions before specifying a particular hose. A common mistake to be avoided involves the use of a transfer hose connected to an 'upstream' valve. Since the hose assembly is open ended, the vacuum that is created when the valve is closed can be overlooked.

However as fluid continues to flow downstream, the vacuum created can often exceed 28 Hg, causing even a 'full vacuum' rated hose to collapse. In this case, additional reinforcement is recommended.



PTFE Hose - SB6S

Smoothbore PTFE

Part No.: SB6S

Construction: Smoothbore

Profile: Medium Flexibility / Medium Pressure

Tube Available: PTFE Virgin / Anti-static Inner Tube

Braid Available: 316 / 304 Stainless Steel

Size Available: 1/8" - 1 1/8"

Temperature: -70°C to 260°C

Low | Med | High

Flexibility

Cycle Life

Pressure Rating

Chemical Resistance

Wall Thickness



Construction

Use: The inner hose core is manufactured from PTFE. No pigments or additives are incorporated, thus giving the hose liner a translucent appearance free from any contamination.

Standards: FDA Approved, Accepted by the U.S. Coast Guard, PTFE Perfluorocarbon Resins meets FDA 21 CFR 177.1550

ISO 1402 – Rubber and plastic hose and assemblies – hydrostatic testing

SAE J517 – Dimensional and performance Specification

SAE 100R14 – PTFE Dimensional and performance Specification

Sintered/Permeation:

Slow Sintered (medium level of permeation)

Specifications

Temperature Correction Factor													
-60	-40	-20	0	20	50	100	120	150	180	200	220	250	260
1.0	1.0	1.0	1.0	1.0	1.0	1.0	0.93	0.93	.85	0.85	0.77	0.77	0.70

Part Number	Size	Internal Diameter (mm)		Wall Thickness (mm)	Outside Diameter (mm)		Min. Bend Radius (mm)	SAE 100R14 Max. Working Pressure		SAE 100R14 Burst Pressure 4:1		Vacuum (mm hg)
		Min.	Max.		Min.	Max.		kPa	Bar	kPa	Bar	
316 Braid	Inch	Min.	Max.	mm	Min.	Max.	mm	kPa	Bar	kPa	Bar	mm hg
SB6S-03-R14	1/8"	3.3	3.5	0.76	5.84	6.35	38	20700	207	82800	828	711.20
SB6S-04-R14	3/16"	4.64	5.2	0.76	7.32	8.2	51	20700	207	82800	828	711.20
SB6S-06-R14	1/4"	6.17	6.73	0.76	8.92	9.47	76	18098	180	72392	723	711.20
SB6S-08-R14	5/16"	7.54	8.38	0.76	10.36	11.63	102	17236	172	68944	689	711.20
SB6S-10-R14	3/8"	9.27	9.77	0.76	12.2	13.21	127	15513	155	62052	620	711.20
SB6S-11-R14	13/32"	10.08	10.85	0.76	13.03	14.19	133	13789	137	55156	551	711.20
SB6S-12-R14	1/2"	12.42	13.18	0.76	15.44	16.71	165	10342	103	41368	413	711.20
SB6S-15-R14	5/8"	15.36	16.38	0.76	18.74	20.02	197	8618	86	34472	344	711.20
SB6S-20-R14	3/4"	18.61	19.38	0.89	21.59	22.86	229	7584	75	30336	303	508.00
SB6S-22-R14	7/8"	21.46	23.0	0.89	24.60	26.90	229	6894	68	27576	275	355.59
SB6S-25-R14	1"	24.63	26.16	0.89	27.80	29.85	305	6205	62	24820	248	355.59
SB6S-28-R14	1 1/8"	27.80	28.34	1.14	31.95	33.50	406	5171	51	20684	206	355.59

* Please note that Hoseflex PTFE HOSE meets and exceeds the stated working and burst pressure (4:1) values of the SAE 100R14 specifications.

* Please note all pressures stated are static

Applications





PTFE HOSE

PTFE Hose - PTFE-HP

Smoothbore High Pressure PTFE

Part No.: PTFE-HP

Construction: Smoothbore

Profile: Low Flexibility / High Pressure

Tube Available: PTFE Virgin Inner Tube

Braid Available: Double 304 Stainless Steel Braid

Cover: Optional Hytrel Cover, use Part Number PTFE-HP-06-H

Size Available: 1/4"

Temperature: -60°C to 260°C

Note: Only available as an assembly

Sintered/Permeation:

Slow Sintered (medium level of permeation)

Low | Med | High

Flexibility

Cycle Life

Pressure Rating

Chemical Resistance

Wall Thickness

Construction

Use:

Slow sintered PTFE hose that is ideal for gas delivery applications due to lower permeation. Double braided to provide higher pressure rating for high pressure gas applications.

Standards:

Part 1.PTFE-E.P.D.M 1.6.1.C.E.4_12

ISO 1402 – Rubber and plastic hose and assemblies – hydrostatic testing

SAE J517 – Dimensional and performance Specification



Specifications

Temperature Correction Factor													
-60	-40	-20	0	20	50	100	120	150	180	200	220	250	260
1.0	1.0	1.0	1.0	1.0	1.0	1.0	0.93	0.93	.85	0.85	0.77	0.77	0.70

Part Number	Size	Tube Wall Thickness	Outside Diameter	Min. Bend Radius	Max. Working Pressure		Min. Burst Pressure	
	inch	mm	mm	mm	kPa	bar	kPa	bar
PTFE-HP-06	1/4"	1.02	11.43	76	32000	320	128000	1280
PTFE-HP-06-H	1/4"	1.02	11.43	76	32000	320	128000	1280

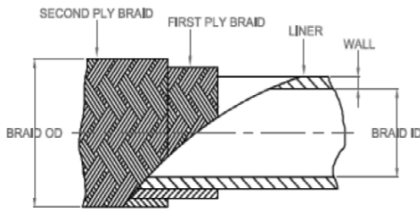

Applications



9
8
7
6
5
4
3
2
1

PTFE HOSE



PTFE HOSE

PTFE Hose - PTFE-UHP

Ultra High Pressure Smoothbore PTFE

Part No.: PTFE-UHP

Construction: Smoothbore

Profile: High Flexibility / High Pressure

Tube Available: PTFE Virgin / Anti-static Inner Tube

Cover: 2 Aramid braids and 1 high tensile 304 maypole wound Stainless steel braid

Size Available: 1/4" - 1"

Temperature: -60°C +260°C

Sintered/Permeation: Slow Sintered (medium level of permeation). 1/4, 3/8" and 1/2" are available in Post Sintered on request (example PTFE-UHP-xx-PS)

Low | Med | High

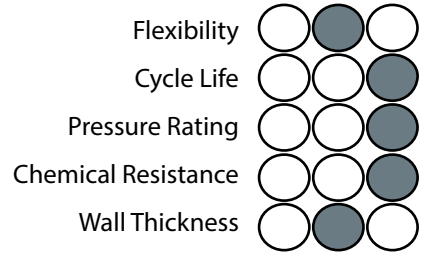

Construction

Use:

Ultra high pressure smoothbore PTFE is highest pressure hose and the lightest weight PTFE Hose on the market. Performing well above its weight due to its excellent routability, bend radius and reduced OD. Used for High pressure gas or fluid applications.

Standards:

FDA Approved, Accepted by the U.S. Coast Guard,
 PTFE Perfluorocarbon Resins meets FDA 21 CFR 177.1550 ISO
 ISO 1402 – Rubber and plastic hose and assemblies – hydrostatic testing
 SAE J517 – Dimensional and performance Specification



Specifications

Temperature Correction Factor													
-60	-40	-20	0	20	50	100	120	150	180	200	220	250	260
1.0	1.0	1.0	1.0	1.0	1.0	1.0	0.93	0.93	.85	0.85	0.77	0.77	0.70

Part Number	Size	Internal Diameter	Outside Diameter	Min. Bend Radius	Working Pressure		Burst Pressure	
	inch	mm	mm	mm	kPa	bar	kPa	bar
PTFE-UHP-06	1/4"	6.20	12.30	38	47500	475	190000	1900
PTFE-UHP-08	5/16"	8.10	14.20	47	45000	450	180000	1800
PTFE-UHP-10	3/8"	9.50	16.00	64	43000	430	175000	1750
PTFE-UHP-12	1/2"	12.70	19.50	74	42500	425	170000	1700
PTFE-UHP-15	5/8"	15.10	22.00	90	36000	360	145000	1450
PTFE-UHP-20	3/4"	20.00	27.50	180	27500	275	110000	1100
PTFE-UHP-25	1"	24.00	31.80	200	25000	250	100000	1000

Applications



1
2
3
4
5
6
7
8
9

PTFE HOSE



PTFE HOSE

PTFE Hose - PTFE-HPPT

High Pressure PTFE Thermoplastic Smoothbore

Part No.: PTFE-HPPT

Construction: Smoothbore

Profile: High Flexibility / High Pressure

Tube Available: PTFE Virgin / Anti-static Inner Tube

Cover: Black Perforated Thermoplastic

Size Available: 1/4" - 13/32"

Temperature: -70°C +260°C

Sintered/Permeation: Slow Sintered (medium level of permeation)

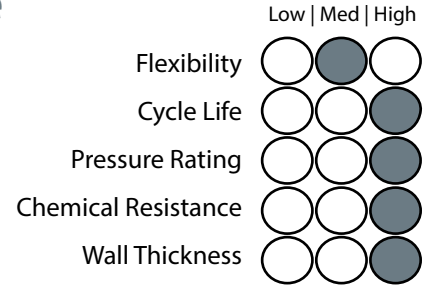

Construction

Use:

High performance gas hose specially processed to minimise permeation applications. Aerosol, gas bottle, dehydration and breathing lines.

Standards:

- FDA Approved, Accepted by the U.S. Coast Guard,
- PTFE Perfluorocarbon Resins meets FDA 21 CFR 177.1550
- ISO 1402 – Rubber and plastic hose and assemblies – hydrostatic testing
- SAE J517 – Dimensional and performance Specification



Specifications

Temperature Correction Factor													
-60	-40	-20	0	20	50	100	120	150	180	200	220	250	260
1.0	1.0	1.0	1.0	1.0	1.0	1.0	0.93	0.93	.85	0.85	0.77	0.77	0.70

Part Number	Size	Internal Diameter (mm)		Wall Thickness (mm)	Outside Diameter (mm)		Min. Bend Radius (mm)	Standard Max. Working Pressure		Min. Burst Pressure	
		Min.	Max.		Min.	Max.		kPa	bar	kPa	bar
PTFE-HPPT-06	1/4"	6.35	6.86	1.02	9.65	10.67	76.2	55200	552	165500	1655
PTFE-HPPT-10	13/32"	10.03	10.54	1.02	13.84	14.86	133	31000	310	124000	1240

Applications



PTFE Hose - CTFB

Tape Wrapped Convoluted PTFE

Part No.: CTFB / CTFBHV

Construction: Tape Wrapped helical convoluted

Profile: High Flexibility / Medium Pressure

Tube Available: PTFE Virgin / Anti-static Inner Tube

Braid Available: 304 / 316 Stainless Steel

Size Available: 3/8" - 4"

Temperature: -50°C / +150°C

Sintered/Permeation: Slow Sintered (medium level of permeation)

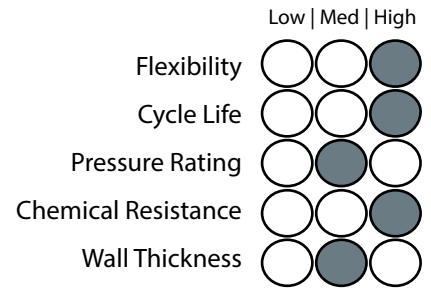

Construction

Use:

Flame resistant convoluted multilayer PTFE hose with fibreglass covering and wire braid reinforcement for use on demanding marine and offshore applications. The convoluted profile ensures easier crimping of the hose and with the approved DNV GL fitting and ferrule range now offers a proven minimum 150K impulse cycle life expectancy at elevated temperatures.

Standards:

PTFE BS2782 Method 327A:1993 ASTM-D 882

DNV GL class programme CP-0183

- Type Approval of flexible hoses of non-metallic material



Specifications

Temperature Correction Factor													
-60	-40	-20	0	20	50	100	120	150	180	200	220	250	260
1.0	1.0	1.0	1.0	1.0	1.0	1.0	0.93	0.93	.85	0.85	0.77	0.77	0.70

Part Number	Size	Internal Diameter	Outside Diameter	Min. Bend Radius	Max. Working Pressure		Min. Burst Pressure		Vacuum	
	inch	mm	mm	mm	kPa	bar	kPa	bar	(bar)	mm hg
CTFB-10	3/8"	9.65	15.8	50	12500	125	4999	500	0.9	675.13
CTFB-12	1/2"	13.45	19.8	65	10501	105	4199	420	0.9	675.13
CTFB-15	5/8"	16.4	23.4	80	9997	100	3999	400	0.9	675.13
CTFB-20	3/4"	19.8	26.9	100	8998	90	3599	360	0.9	675.13
CTFB-25	1"	25	32.9	125	7998	80	3199	320	0.9	675.13
CTFB-32	1 1/4"	32.3	39.75	150	6398	64	2558	256	0.9	675.13
CTFB-38	1 1/2"	38.3	46.1	200	5302	53	2117	212	0.9	675.13
CTFB-50	2"	51.5	60.5	250	3503	35	1400	140	0.5	375.16

High Vacuum Tape Wrapped Convoluted Hose (External Spring)										
CTFBHV-38	1 1/2"	38.3	46.1	200	5302	53	2117	212	9.4	711.19
CTFBHV-50	2"	51.5	60.5	250	3503	35	1400	140	9.4	711.19
CTFBHV-75	3"	76.20	93.47	381	1700	17	6900	69	9.4	711.19
CTFBHV-100	4"	101.60	123.19	610	1000	10	4100	41	9.4	711.19

Applications



1 2 3 4 5 6 7 8 9

PTFE HOSE

PTFE Hose - ECTB

Easyflex Convoluted PTFE

Part No.: ECTB6S / ECTB4S

Construction: Convoluted

Profile: High Flexibility / Medium Pressure

Tube Available: PTFE Virgin / Anti-static Inner Tube

Braid Available: 304 / 316 Stainless Steel

Size Available: 3/8" - 2"

Temperature: -70°C to 260°C

Sintered/Permeation: Slow Sintered (medium level of permeation)

	Low	Med	High
Flexibility			
Cycle Life			
Pressure Rating			
Chemical Resistance			
Wall Thickness			

Construction

Use:

General purpose convoluted PTFE hose, convolutions self cleaning spiral construction. Applications include food transfer, chemical dosing, oil, hydraulics and water treatment.



Standards:

FDA Approved, Accepted by the U.S. Coast Guard, PTFE Perfluorocarbon Resins meets FDA 21 CFR 177.1550

Specifications

Temperature Correction Factor													
-60	-40	-20	0	20	50	100	120	150	180	200	220	250	260
1.0	1.0	1.0	1.0	1.0	1.0	1.0	0.93	0.93	.85	0.85	0.77	0.77	0.70

Part Number		Size	Internal Diameter (mm)		Wall Thickness	Outside Diameter (mm)		Min. Bend Radius	Standard Max. Working Pressure		Min. Burst Pressure	
316 Braid	304 Braid	Inch	Min.	Max.	mm	Min.	Max.	mm	kPa	Bar	kPa	Bar
ECTB6S-10	ECTB4S-10	3/8"	9.14	9.91	0.76	14.73	15.75	20.30	13800	138	41400	414
ECTB6S-12	ECTB4S-12	1/2"	12.45	13.21	0.89	18.29	19.30	25.40	10300	103	31000	310
ECTB6S-15	ECTB4S-15	5/8"	15.37	16.38	0.89	21.59	22.61	50.80	8300	83	24800	248
ECTB6S-20	ECTB4S-20	3/4"	18.54	19.56	0.89	24.00	25.27	63.50	6900	69	20700	207
ECTB6S-22	ECTB4S-22	7/8"	21.84	22.86	0.89	27.94	29.46	76.20	5700	57	17200	172
ECTB6S-25	ECTB4S-25	1"	24.89	26.16	1.02	32.13	33.66	88.90	4600	46	13800	138
ECTB6S-32	ECTB4S-32	1 1/4"	31.00	33.00	1.02	39.00	42.00	127.00	3400	34	10300	103
ECTB6S-38	ECTB4S-38	1 1/2"	37.50	40.50	1.02	46.99	49.20	152.40	3000	30	9000	90
ECTB6S-50	ECTB4S-50	2"	48.00	52.00	1.02	58.67	59.70	190.50	2300	23	6900	69

Applications



PTFE Hose - SCTB

Encapsulated PTFE

Part No.: SCTB
Construction: Convoluted
Profile: High Flexibility / Low Pressure
Tube Available: PTFE Virgin / Anti-static Inner Tube
Braid Available: 304 / 316 Stainless Steel
Size Available: 1/4" - 6"
Temperature: -70°C to 260°C
Sintered/Permeation: Slow Sintered (medium level of permeation)

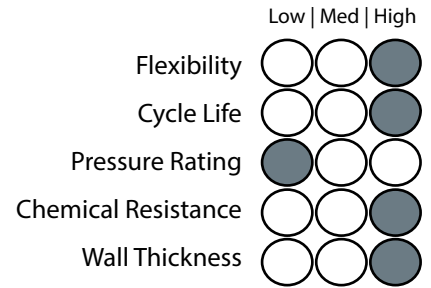

Construction

Use:

The PTFE spiral Liner is extruded within the hose and encapsulated over the flange or fitting, creating a total hygienic seal. The most hygienic PTFE on the market. Approved for food, chemical, cosmetic and pharmaceutical applications.

Standards:

FDA Approved, Accepted by the U.S. Coast Guard,
 PTFE Perfluorocarbon Resins meets FDA 21 CFR 177.1550



Specifications

Temperature Correction Factor													
-60	-40	-20	0	20	50	100	120	150	180	200	220	250	260
1.0	1.0	1.0	1.0	1.0	1.0	1.0	0.93	0.93	.85	0.85	0.77	0.77	0.70

Part Number	Size	Internal Diameter (mm)		Wall Thickness	Outside Diameter (mm)		Min. Bend Radius	Max. Working Pressure		Min. Burst Pressure		Vacuum
		Min.	Max.		Min.	Max.		kPa	Bar	kPa	Bar	
SCTB-06	1/4"	5.5	6.9	0.76	11.4	13.3	25	1500	15	4500	45	744
SCTB-10	3/8"	8.5	10.5	0.76	14.7	16.5	25	1500	15	4500	45	744
SCTB-12	1/2"	11.6	13.6	0.89	17.9	20.0	25	1500	15	4500	45	711
SCTB-15	5/8"	15.1	16.4	0.89	24.7	25.8	35	1500	15	4500	45	711
SCTB-20	3/4"	149.5	20.5	1.00	28.6	31.4	55	1500	15	4500	45	680
SCTB-25	1"	25.4	25.5	1.10	34.2	38.2	85	1500	15	4500	45	653
SCTB-32	1 1/4"	34.5	32.5	1.15	41.9	46.1	100	1500	15	4500	45	503
SCTB-38	1 1/2"	36.5	37.5	1.45	47.2	49.9	120	1500	15	4500	45	301
SCTB-43	1 3/4"	44.5	45.5	1.45	55.8	61.4	135	1500	15	4500	45	301
SCTB-50	2"	49.5	50.5	1.50	60.5	66.7	165	1500	15	4500	45	120
SCTB-65	2 1/2"	62.5	63.5	1.60	80.9	89.1	230	1000	10	3000	30	102
SCTB-80	3"	73.5	74.5	1.60	90.4	99.6	260	800	8	2400	24	102
SCTB-100	4"	94.5	99.5	1.82	121.1	127.5	400	800	8	2400	24	102
SCTB-150	6"	148	154	2.5	176	188	520	500	5	1500	15	105

Note: External suction/vacuum wire can be introduced to achieve high vacuum ratings

Applications



1 2 3 4 5 6 7 8 9

PTFE HOSE



PTFE HOSE

PTFE Hose - SS1SCT

Encapsulated PTFE SS1 Metallic Hose

Part No.: SS1SCT

Construction: Smoothbore PTFE / Convuluted Metallic Hose

Profile: Low Flexibility / Low Pressure

Tube Available: PTFE Virgin / Anti-static Inner Tube

Braid Available: 304 / 316 Stainless Steel

Size Available: 1/2" - 6"

Temperature: -70°C to 260°C

Sintered/Permeation: Slow Sintered (medium level of permeation)

Low | Med | High

Flexibility

Cycle Life

Pressure Rating

Chemical Resistance

Wall Thickness

Construction

Use:

The PTFE Smoothbore Liner is extruded within the metallic hose assembly and encapsulated over the flange or fitting, creating a total hygienic seal. The most hygienic PTFE on the market. Approved for food, chemical, cosmetic and pharmaceutical applications.

Standards:

FDA Approved, Accepted by the U.S. Coast Guard, PTFE Perfluorocarbon Resins meets FDA 21 CFR 177.1550

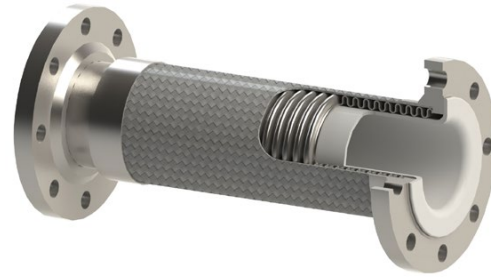

Specifications

Temperature Correction Factor													
-60	-40	-20	0	20	50	100	120	150	180	200	220	250	260
1.0	1.0	1.0	1.0	1.0	1.0	1.0	0.93	0.93	.85	0.85	0.77	0.77	0.70

Part Number	Size inch	Outside Diameter mm	Min. Bend Radius	Working Pressure		Burst Pressure	
				kPa	Bar	kPa	Bar
SS1SCT-12	1/2"	18.00	LIMITED FLEXIBILITY	6500	300	30000	300
SS1SCT-20	3/4"	28.00		5000	200	20000	200
SS1SCT-25	1"	33.70		4400	176	17600	176
SS1SCT-32	1 1/4"	42.60		3500	140	14000	140
SS1SCT-40	1 1/2"	50.90		2800	112	11200	112
SS1SCT-50	2"	61.70		2000	80	8000	80
SS1SCT-65	2 1/2"	85.30		1800	72	7200	72
SS1SCT-80	3"	100.30		1800	72	7200	72
SS1SCT-100	4"	126.30		1600	64	6400	64
SS1SCT-125	5"	155.30		1400	14	5600	56
SS1SCT-150	6"	180.30		1200	12	4800	48

Applications



9
8
7
6
5
4
3
2
1
PTFE HOSE

PTFE Hose - SF6S

SLICKFLEX Smoothbore Inner / Convuluted Outer PTFE



Part No.: SF6S

Construction: Smoothbore inner with Convuluted on the outer

Profile: High Flexibility / Medium Pressure

Tube Available: PTFE Virgin / Anti-static Inner Tube / PFA

Braid Available: 316 Stainless Steel

Size Available: 1/4" - 2"

Temperature: -70°C to 260°C

Vacuum Resistance: Full Vacuum up to 130°C

Sintered/Permeation: Slow Sintered (medium level of permeation)

Low | Med | High

Flexibility

Cycle Life

Pressure Rating

Chemical Resistance

Wall Thickness

Construction

Use: PTFE liner tube is smoothbore on the inside but convoluted on the outside, to combine the ease of assembly and high flow rates of a smooth bore hose with the flexibility and kink resistance. Pharmaceutical, Bio-tech, Food & Beverage, Chemical, Petro-chemical, General Purpose Industrial, Automotive OE & Autosport

Standards: PTFE Perfluorocarbon Resins meets FDA 21 CFR 177.1550 (on request) ISO 1402 – Rubber and plastic hose and assemblies

PTFE T62X according to "ASTM D4895, Type 1, Grade4, Class B", EU Food, USP Class VI.



Options:

Blue EPDM Cover



Silicon Cover



Polypropylene Braid



Encapsulated Hose Ends



Specifications

Temperature Correction Factor													
-60	-40	-20	0	20	50	100	120	150	180	200	220	250	260
1.0	1.0	1.0	1.0	1.0	1.0	1.0	0.93	0.93	.85	0.85	0.77	0.77	0.70

Part Number	Size	Internal Diameter	Wall Thickness	Outside Diameter (mm)		Min. Bend Radius	Standard Max. Working Pressure		Min. Burst Pressure	
	inch			mm	mm		mm	kPa	bar	kPa
SF6S-06	1/4"	6.8	1.6	8.6	9.6	19	8800	88	35000	350
SF6S-10	3/8"	10.0	1.6	12.5	13.5	25	8000	80	32000	320
SF6S-12	1/2"	13.4	1.6	16.4	18.0	38	6000	60	24000	240
SF6S-20	3/4"	19.1	1.8	20.0	24.1	50	6000	60	24000	200
SF6S-22	7/8"	21.0	2.1	23.8	27.0	55	5500	55	20000	170
SF6S-25	1"	25.5	2.2	30.0	31.4	70	5000	50	20000	160
SF6S-32	1 1/4"	31.8	2.65	37.3	39.3	100	4500	45	18000	180
SF6S-38	1 1/2"	38.1	3	45.0	46.1	140	4000	40	16000	160
SF6S-50	2"	50.8	3	59.1	61.0	200	3000	30	12000	120

Applications



1 2 3 4 5 6 7 8 9

PTFE HOSE



PTFE HOSE

PTFE Hose - CONPRO

Convuluted PTFE

Part No.: CONPRO

Construction: Convuluted

Profile: High Flexibility / Low Pressure

Tube Available: PTFE Virgin / Anti-static Inner Tube

Braid Available: Polypropylene

Size Available: 1/2" - 3"

Temperature: -70°C to 260°C

Sintered/Permeation: Slow Sintered (medium level of permeation)

Low | Med | High

Flexibility

Cycle Life

Pressure Rating

Chemical Resistance

Wall Thickness

Construction

Use:

High corrosive environment. Conpro is more suited to use in more arduous applications throughout the process plant industry. Polypropylene braid produces a low electrically conductive assembly.



Standards:

FDA Approved, Accepted by the U.S. Coast Guard, PTFE Perfluorocarbon Resins meets FDA 21 CFR 177.1550

Specifications

Temperature Correction Factor													
-60	-40	-20	0	20	50	100	120	150	180	200	220	250	260
1.0	1.0	1.0	1.0	1.0	1.0	1.0	0.93	0.93	.85	0.85	0.77	0.77	0.70

Part Number	Size	Internal Diameter	Wall Thickness	Outside Diameter (mm)		Min. Bend Radius	Standard Max. Working Pressure		Min. Burst Pressure	
				Tube	Braid		kPa	bar	kPa	bar
CONPRO-12	1/2"	11.6	0.89	13.38	21.4	50	1000	10	4000	40
CONPRO-15	5/8"	15.1	0.89	16.88	26.3	65	1000	10	4000	40
CONPRO-20	3/4"	19.5	1	21.5	31.1	55	1000	10	4000	40
CONPRO-25	1"	24.5	1.1	26.7	36.7	85	1000	10	4000	40
CONPRO-32	1 1/4"	31.5	1.15	33.80	44.4	100	1000	10	4000	40
CONPRO-40	1 1/2"	36.5	1.45	39.4	49.7	120	1000	10	4000	40
CONPRO-45	1 3/4"	44.5	1.45	47.40	58.3	135	1000	10	4000	40
CONPRO-50	2"	49.5	1.5	52.5	62.5	165	800	8	3200	32
CONPRO-65	2 1/2"	62.5	1.6	65.7	83.4	230	700	7	2800	28
CONPRO-80	3"	73.5	1.6	76.7	92.9	260	600	6	2400	24

Applications



PTFE Hose - PCTH

Chlorine Transfer PTFE

Part No.: PCTH
Construction: Convoluted
Profile: High Flexibility / Medium Pressure
Tube Available: PTFE Virgin Inner Tube with an intergal fibreglass cover
Braid Available: Two layers of Kynar reinforcement braid
Size Available: 1/2" - 1"
Temperature: -70°C to 260°C
Sintered/Permeation: Slow Sintered (medium level of permeation)

Low | Med | High

Flexibility	<input type="radio"/>	<input type="radio"/>	<input checked="" type="radio"/>
Cycle Life	<input type="radio"/>	<input type="radio"/>	<input checked="" type="radio"/>
Pressure Rating	<input type="radio"/>	<input checked="" type="radio"/>	<input type="radio"/>
Chemical Resistance	<input type="radio"/>	<input type="radio"/>	<input checked="" type="radio"/>
Wall Thickness	<input type="radio"/>	<input type="radio"/>	<input checked="" type="radio"/>

Construction

Use:
 It's the only hose that can adequately transfer chlorine in a safe manner. Exclusive design resists rugged handling and collapse.

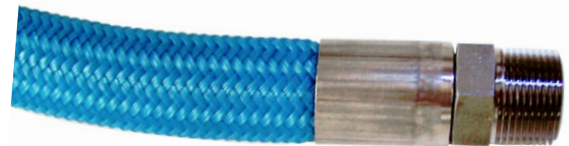

Standards:
 FDA Approved, Accepted by the U.S. Coast Guard,
 PTFE Perfluorocarbon Resins meets FDA 21 CFR 177.1550
 Chlorine Institute Pamphlet 6. Appendix A

Specifications

Temperature Correction Factor													
-60	-40	-20	0	20	50	100	120	150	180	200	220	250	260
1.0	1.0	1.0	1.0	1.0	1.0	1.0	0.93	0.93	.85	0.85	0.77	0.77	0.70

Part Number	Size	Internal Diameter	Outside Diameter (mm)	Min. Bend Radius	Standard Max. Working Pressure		Min. Burst Pressure		
					inch	mm	Braid	mm	kPa
PCTH-12	1/2"	13.72	23.37	38		3400	34	13000	138
PCTH-25	1"	26.54	35.20	152		2600	26	12900	129

Alternative products:
 Refer to Monel Metallic Hose - Page 44

Applications



1
2
3
4
5
6
7
8
9

PTFE HOSE



PTFE HOSE

PTFE Hose - PTFE-UHP-SILVERSSNAKE

PTFE Ultra High Pressure Gas Cylinder Hose

Part No.: PTFE-UHP-SILVERSSNAKE

Construction: Smoothbore

Profile: High Flexibility / High Pressure

Tube Available: PTFE Virgin / Anti-static Inner Tube

Cover: 2 Aramid braids and 1 high tensile 304 maypole wound stainless steel braid

Whip Restraints - Stainless steel anti whip restraint wire safety system

Size Available: 1/4"

Temperature: -60°C +260°C

Sintered/Permeation: Slow Sintered (medium level of permeation). 1/4, 3/8" and 1/2" are available in Post Sintered on request (example PTFE-UHP-xx-PS)

Low | Med | High

Flexibility

Cycle Life

Pressure Rating

Chemical Resistance

Wall Thickness

Construction

Use: The PTFE Ultra High Pressure Gas Cylinder Hose is the most advanced high-pressure hose on the market. It outperforms expectations with its exceptional routability, tight bend radius, and reduced outer diameter, making it ideal for high-pressure gas and fluid applications.

Standards:

- ISO 1402 – Rubber and plastic hose and assemblies – hydrostatic testing
- ISO 14113 - Gas and welding equipment - Rubber and Plastic Hoses assembled for compressed and liquefied up to a maximum design pressure of 450 bar.
- CGA E-9:2004 - Standard of flexible PTFE lined pigtails for compressed gas services.

Applications: Oxygen Cylinder, Argon Cylinder, Nitrogen Cylinder, Hydrogen Cylinder, Acetylene Cylinder

Standard Lengths: 600mm, 800mm, 1200mm, 1800mm, 2400mm, 3600mm (custom lengths available)



Specifications

Temperature Correction Factor													
-60	-40	-20	0	20	50	100	120	150	180	200	220	250	260
1.0	1.0	1.0	1.0	1.0	1.0	1.0	0.93	0.93	0.85	0.85	0.77	0.77	0.70

Part Number	Size	Internal Diameter	Outside Diameter	Min. Bend Radius	Working Pressure		Burst Pressure	
	inch	mm	mm	mm	kPa	bar	kPa	bar
PTFE-UHP-06	1/4"	6.20	12.30	38	47500	475	190000	1900





PTFE HOSE

PTFE Hose - TEFLEX

Teflex Silicone Jacket PTFE

Part No.: TEFLEX

Construction: Smoothbore

Profile: High Flexibility / High Pressure

Tube Available: PTFE Virgin Inner Tube impregnated fiberglass braid

Braid Available: 304 / 316 Stainless Steel

Cover: Silicone

Size Available: 1/4" - 1"

Temperature: -70°C +204°C

Sintered/Permeation: Slow Sintered (medium level of permeation)

Low | Med | High

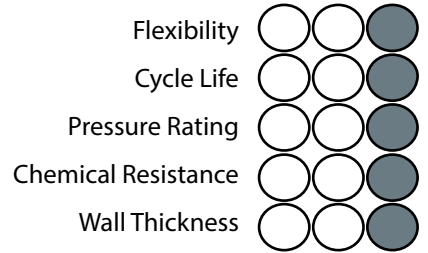

Construction

Use:

Liquid food and beverage transfer, also suitable for air, water, chemical, oil and automotive applications
Hygienic food grade cover ideal for food and pharmaceutical applications.



Standards:

FDA Approved, Accepted by the U.S. Coast Guard,
PTFE Perfluorocarbon Resins meets FDA 21 CFR 177.1550

Specifications

Temperature Correction Factor													
-60	-40	-20	0	20	50	100	120	150	180	200	220	250	260
1.0	1.0	1.0	1.0	1.0	1.0	1.0	0.93	0.93	.85	0.85	0.77	0.77	0.70

Part Number	Size	Internal Diameter	Outside Braid O.D.	Outside Jacket O.D.	Min. Bend Radius (Static)	Standard Max. Working Pressure		Min. Burst Pressure	
	inch	mm	mm	mm	mm	kPa	bar	kPa	bar
TEFLEX-SXX-06	1/4"	6.22	11.81	14.61	44	22500	225	90000	900
TEFLEX-SXX-10	3/8"	9.14	14.86	17.65	70	20000	200	80000	800
TEFLEX-SXX-12	1/2"	12.50	18.21	21.01	108	11000	110	45000	450
TEFLEX-SXX-15	5/8"	15.50	21.94	24.99	140	10000	100	40000	400
TEFLEX-SXX-20	3/4"	18.80	24.74	27.79	178	8800	88	35000	350
TEFLEX-SXX-25*	1"	25.40	33.66	38.74	292	6200	62	25000	250

* 1" Hose construction is PTFE Liner with double stainless steel Braid

Table Key :

Silicone Jacket Colour (SXX)

SRD = Red SBK = Black SBL = Blue SWH = White

Applications



PTFE Hose - RFEP

Rubber FEP Liner

Part No.: RFEP

Colour: Green / Yellow Labeling

Tube Available: FEP liner Smoothbore

Cover: Green EPDM rubber cover, covered and reinforced with multi-layered rubber

Reinforcement: Spiral-wound polyester cords and a double helix wire

Size Available: 1/2" - 4"

Temperature: -40°C +177°C

Vacuum Resistance: Full Vacuum

Sintered/Permeation: Slow Sintered (medium level of permeation)

Low | Med | High

Flexibility

Cycle Life

Pressure Rating

Chemical Resistance

Wall Thickness

Construction

Use:

Designed for extended use in hostile environments involving severe chemical, thermal, and mechanical stresses. Does not suffer aging or embrittlement, even with extreme thermal cycling.



Standards:

Pharmacopoeia Class VI, USDA, FDA-approved

Specifications

Temperature Correction Factor													
-60	-40	-20	0	20	50	100	120	150	180	200	220	250	260
1.0	1.0	1.0	1.0	1.0	1.0	1.0	0.93	0.93	.85	0.85	0.77	0.77	0.70

Part Number	Nominal Dia.		Working pressure		Vacuum Rating	Min Bend Radius	Weight Per Mtr
	Inches	O.D (mm)	kPa	Bar	in. Hg	mm	Kg
RFEP-12	1/2"	24.13	2413	24	29.9	67.31	0.15
RFEP-20	3/4"	31.75	2413	24	29.9	88.90	0.23
RFEP-25	1"	39.37	3102	31	29.9	101.60	0.32
RFEP-32	1 1/4"	44.45	2585	25	29.9	215.90	0.40
RFEP-38	1 1/2"	54.10	2585	24	29.9	266.70	0.44
RFEP-50	2"	68.07	2068	20	29.9	330.20	0.62
RFEP-75	3"	96.52	1723	17	29.9	533.40	1.15
RFEP-100	4"	127.00	1206	12	29.9	990.60	1.58
RFEP-150	6"	181.10	689	7	29.9	1473.20	2.15

Note: Fittings can be Encapsulated

Applications



PTFE Hose - PTFEIT

PTFE Imperial Tubing

Part No.: PTFEIT
Construction: Smoothbore
Profile: High Flexibility / Low Pressure
Tube Available: PTFE Virgin Inner Tube
Metric Size Available: 2mm - 28mm I.D. (Larger sizes upon Request)
Imperial Size Available: 1/16" - 5/8" I.D. (Larger sizes upon Request)
Temperature: -70°C to 260°C
Lengths: 25m, 50m and 100m rolls
Sintered/Permeation: Slow Sintered (medium level of permeation)

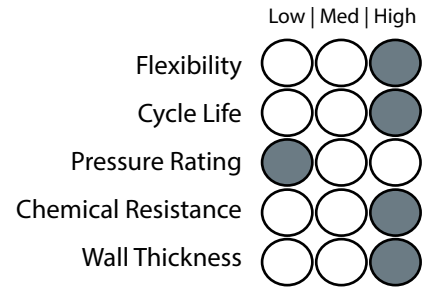

Construction

Use:

PTFE provides the ultimate in lubricity, high temperature use, chemical resistance, biocompatibility and precision extruded tolerances. Food, Medical and chemical transfer applications.

Standards:

FDA Approved
 PTFE Perfluorocarbon Resins meets FDA 21 CFR 177.1550



Specifications

Temperature Correction Factor													
-60	-40	-20	0	20	50	100	120	150	180	200	220	250	260
1.0	1.0	1.0	1.0	1.0	1.0	1.0	0.93	0.93	.85	0.85	0.77	0.77	0.70

IMPERIAL SIZES				
Part Number	Size O.D. x I.D.	O.D. (mm)	I.D. (mm)	Max Pressure (kPa)
PTFEIT-0201	1/8" x 1/16"	3.175	1.5875	1034
PTFEIT-0302	3/16" x 1/8"	4.7625	3.175	1034
PTFEIT-0403	1/4" x 3/16"	6.35	4.7625	1034
PTFEIT-0504	5/16" x 1/4"	7.9375	6.35	1034
PTFEIT-0604	3/8" x 1/4"	9.525	6.35	1034
PTFEIT-0605	3/8" x 5/16"	9.525	7.9375	1034
PTFEIT-0806	1/2" x 3/8"	12.7	9.525	1034
PTFEIT-1008	5/8" x 1/2"	15.875	12.7	1034
PTFEIT-1210	3/4" x 5/8"	19.05	15.875	1034

Applications



1 2 3 4 5 6 7 8 9

PTFE HOSE



PTFE HOSE

PTFE Hose - PTFEMT

PTFE Metric Tubing

Part No.: PTFEMT

Construction: Smoothbore

Profile: High Flexibility / Low Pressure

Tube Available: PTFE Virgin Inner Tube

Metric Size Available: 2mm - 28mm I.D. (Larger sizes upon Request)

Imperial Size Available: 1/16" - 5/8" I.D. (Larger sizes upon Request)

Temperature: -70°C to 260°C

Lengths: 25m, 50m and 100m rolls

Sintered/Permeation: Slow Sintered (medium level of permeation)

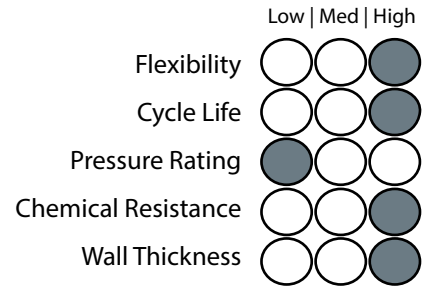

Construction

Use:

PTFE provides the ultimate in lubricity, high temperature use, chemical resistance, biocompatibility and precision extruded tolerances. Food, Medical and chemical transfer applications.

Standards:

FDA Approved

PTFE Perfluorocarbon Resins meets FDA 21 CFR 177.1550



Specifications

Temperature Correction Factor													
-60	-40	-20	0	20	50	100	120	150	180	200	220	250	260
1.0	1.0	1.0	1.0	1.0	1.0	1.0	0.93	0.93	.85	0.85	0.77	0.77	0.70

METRIC SIZES			
Part Number	O.D. (mm)	I.D. (mm)	Max Pressure (kPa)
PTFEMT-0402	4	2	1034
PTFEMT-0503	5	3	1034
PTFEMT-0604	6	4	1034
PTFEMT-0805	8	5	1034
PTFEMT-0806	8	6	1034
PTFEMT-1008	10	8	1034
PTFEMT-1209	12	9	1034
PTFEMT-1412	14	12	1034
PTFEMT-1614	16	14	1034
PTFEMT-2420	24	20	1034
PTFEMT-3228	32	28	1034

Applications



9
8
7
6
5
4
3
2
1

PTFE HOSE

PTFE Jacketed Hose

PTFE Jacketed Hose

A Jacketed assembly consists of a “hose within a hose.”

An inner or primary media conveying hose is enclosed or jacketed by a larger diameter hose. The hoses are joined at each end by specially designed fittings so that there is no media pathway between the two hoses.

Jacketed assemblies are often specified when the primary media must be kept at either an elevated or cryogenic temperature. Steam is often circulated through the jacket hose to keep a viscous material in the inner hose hot and easily conveyed. A vacuum can also be pulled on the jacket hose to insulate cryogenic liquids being conveyed in the inner hose.

The media typically is steam, hot oil or hot water to raise the temperature of the fluid moved in the internal hose. Also cold products such as liquid helium or nitrogen can be used to lower the temperature of the fluid with-in the internal hose.

Following Applications:

- Heated processes
- Rail car and tank truck loading/unloading
- Marine Transfer
- Flexible connections to vibrating equipment
- To relieve pump housing stresses
- Hazardous material piping system using an alarmed vacuum jacket
- Safety barrier for toxic processes
- Leak detection systems
- Liquefied food transfer systems
- Chlorine transfer
- Cryogenics (fast freezing)

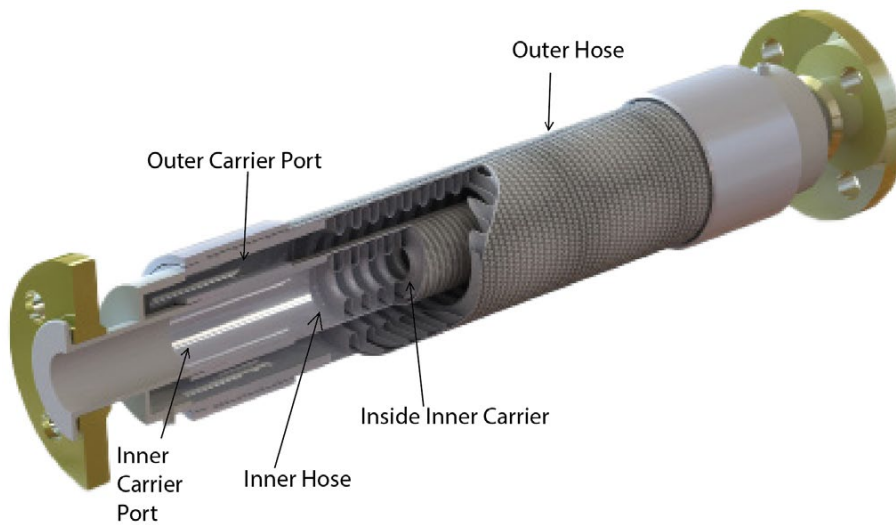

Inner hose nb size	6mm	10mm	12mm	19mm	25mm	32mm	38mm	50mm	65mm	75mm	100mm
Outer hose nb size	12mm	19mm	19mm	32mm	38mm	50mm	65mm	75mm	100mm	150mm	150mm
Inner hose max pressure (kPa)	18089	15513	10342	6900	4600	3400	3000	2300	1000	800	800



02



STAINLESS STEEL HOSE VITALFLEX®



Stainless Steel hose Range

JACKETED HOSE

Size : 1/4" to 14"

Working Pressure : 1310 to 21546 kPa

Page 37



SEISMIC JOINTS

Size : 1/4" to 14"

Working Pressure : 20 to 29523 kPa

Page 38



METALLIC HOSE - ANNULAR

Size : 1/2" to 4"

Working Pressure : 20 to 29523 kPa

Page 39



METALLIC HOSE - OMEGA / BRAIDED BRAID

Size : 5" to 20"

Working Pressure : 100 to 10000 kPa

Page 40



METALLIC HOSE - HIGH PRESSURE

Size : 1/4" to 6"

Working Pressure : 35 to 28283 kPa

Page 41



METALLIC HOSE - ULTRA HIGH PRESSURE

Size : 1/4" to 2"

Working Pressure : 103 to 30378 kPa

Page 42



METALLIC HOSE - EXTREME HIGH PRESSURE

Size : 3" to 4"

Working Pressure : 8618 kPa

Page 43



METALLIC HOSE - MONEL

Size : 1/4" to 3"

Working Pressure : 2164 to 20753 kPa

Page 44



PUMP CONNECTORS - M/S TABLE 'E'

Size : 2" to 8"

Working Pressure : 1201 to 2501 kPa

Page 45

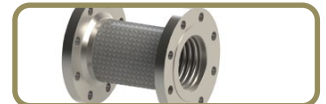

PUMP CONNECTORS - 304 S/S BSPT MALE

Size : 3/4" to 2"

Working Pressure : 2501 to 5003 kPa

Page 46

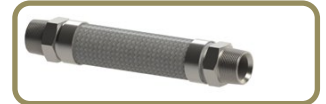

VITALFLEX HOSE - UHP-SILVER SNAKE

Size : 1/4"

Working Pressure : 1000 to 40500 kPa

Page 47



BITUMEN HOSE - CONVOLUTED

Size : 2 1/2"

Working Pressure : 4002 kPa

Page 48



METALLIC HOSE - ROPE LAGGED

Size : 6" - 10"

Working Pressure : 1820 kPa to 2530 kPa

Page 49



TTMA DROP HOSE

Size : 3" to 4"

Working Pressure : 2501 to 3202 kPa

Page 50

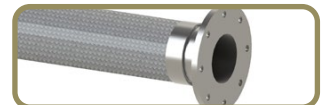

STRIPWOUND HOSE

Size : 3/4" to 12"

Profile : Convoluted

Page 51-52



VACUUM JACKETED HOSES

Size : 5/8" to 2"

Profile : Annular / Close Pitch

Page 53-58



Stainless Steel Hose Design

Introduction

The VITALFLEX® range is especially designed to achieve several objectives in pipe work design. These include, absorption or vibration, operate under vacuum, handle temperature extremes, suppress rigid pipe noise transmitted, accommodate reciprocating and flexing movement, operate effectively under high pressures and adjust or correct for misalignment.

VITALFLEX® hose is a general purpose industrial hose and is available in different grades of stainless steel including 304, 316, 321, Monel, C276 & Inconel.

Convoluting Hose Design

The corrugated hose is manufactured from a cylindrical, thin walled tube formed from rolled strip and welded at the seam. Impressed into this tube is a corrugated annular profile. Annular corrugation means each convolution is perpendicular to the centre line of the hose giving a distinct advantage of movement with each corrugation being relatively independent of movement from each other. When the corrugations are closely spaced, the hose is referred to as 'closed pitch' hose. Conversely, when the corrugations are more widely spaced, the hose is referred to as 'open pitch'.

Metallic – Excellence in liquid and gas transfer applications



Temperature

Contingent upon the extremes of temperature; hot or cold metal is a positive choice as it can withstand temperature extremes.

Chemicals

Metal hose is an excellent option as it effectively controls exposure to a wide range of chemicals – both internal and external.

Permeation

Metal hose is not subject to permeation whereas non metal hose can allow permeation through the hose wall material. Pacific Hoseflex has Australian Gas Approved (AGA) certified hose to assure customers of compliance.

Failure

Generally speaking, metal hoses do not disintegrate rapidly causing any major failure. Warning signs are evident that leaks are present and the medium escapes gradually. Nonmetallic hoses can be prone to sudden failure.

External Abrasion and Over bending

A range of options exist to prevent these occurrences; including external braid, spring guards, rubber and PVC covers and protective sleeves.

Heat and fire

Our metal hoses maintain form and structure up to 700°C

Fittings / Flanges

We can adapt virtually any fittings and flanges to a metal hose other hose products require special and significant variances. We specialize in providing flexible options.

Certified Welding methods:

- AS4041 Class 1
- ASME B31.3
- ASME IX
- AS/NZS 3992
- ASME BPVC.IX & AS 1554.1 SP



Stainless Steel Hose Vacuum

The VITALFLEX® hose in externally pressurized system (under vacuum).

When a corrugated metal hose is considered to be used in a system which is externally pressurized or under vacuum conditions (i.e. vacuum pumps), the question as to how the hose will behave under “full vacuum” or “perfect vacuum” is often asked.

The definition of vacuum is used to describe any pressure that is lower than standard atmospheric pressure. The most widely accepted unit of vacuum measurement is the Torr (after an Italian scientist Torricelli). So one standard atmospheric pressure can be expressed (in the units more commonly used within our community) as the following:

1 atmosphere = 760 Torr = 14.7 PSI

According to Columbia Encyclopedia: “a perfect vacuum has never been obtained..” and therefore expressions “full vacuum” or “perfect vacuum” are used loosely to express conditions with near “0” pressure. Take a look at the table below to compare different “vacuum conditions”:

	Pressure (Torr)	Pressure (PSI)
Vacuum Cleaner	600	11.60
Liquid Ring Vacuum Pump	24	0.46
Rotary Vane Pump	1 to 0.01	0.02 to 0.0002
Near Earth Outer Space	0.00001	0.00000002

Corrugated hose can be used under vacuum conditions and will not be overstressed under such condition, provided the hose section is adequately braced against buckling. The design approach is similar to that for internally pressurized system keeping in mind that external air pressure causes the hose to contract inwardly (rather than expand axially). The proper design though, requires evaluation of the system as a whole (not just one segment – such as corrugated hose – at a time).

1
2
3
4
5
6
7
8
9

STAINLESS STEEL HOSE



Stainless Steel Hose Design

Flexibility

The flexibility of the VITALFLEX® hose is the result of the bending of the metal corrugations. Service life varies depending upon the severity of the flexing, temperature, corrosive conditions, pressure and vibration to which the hose is subjected.

Unless restrained, corrugated hose will elongate when subjected to increased internal pressure. Restraint is provided by a braided covering, consisting of a tubular sheath of woven metal wires fitted tightly over the corrugated hose and secured at each end. Bending and flexibility of the corrugated hose is not appreciably affected by the wire braid covering.



Tolerances

The nominal length refers to the hose complete with end fittings and indicates the total length. Unless otherwise arranged when ordering, the following length tolerances must be taken into account when checking the nominal length:

Dimensions in mm

Nominal Lengths	up to 500		over 500 up to 1000		over 1000 up to 2000	
	Min.	Max.	Min.	Max.	Min.	Max.
ISO 10380:2012	495	515	990	1030	1980	2060

- The "End to End" or "Seat to Seat" length of a hose assembly shall be the length as ordered to a tolerance of +3% / -1
- Smaller length tolerances are possible, but must be specially agreed when ordering.
- Refer to page 332 for hose measurement guide

Braid

Annular Braid

Style: Open pitch
Material: 316 and 304
Pressure: Medium



Omega Braid

Style: Close Pitch
Material: 316 and 304
Pressure: Medium



Braided Braid

Style: Open Pitch
Material: 316 and 304
Pressure: High



Stainless Steel Hose Design

Flow Velocity Consideration

The flow velocity in corrugated metal hose should never exceed 150 ft/sec for gas, or 75 ft/sec for liquids. When the hose is installed in a bent condition, these flow values should be reduced proportionally to the degree of the bend. Where the flow velocity exceeds these rates, an interlocked metal hose liner is recommended. Refer to page 331 for Nomograph.

Service Life

The VITALFLEX® is engineered to provide maximum service life when properly installed. Incorrect installation, incorrect flexing or careless handling in an application will reduce the effective service life of the hose and cause premature failure of an assembly. The service life can be affected by many external factors, the environment surrounding the assembly as well as the media being transferred will together determine a general guide to the service life.



Non Destructive Pressure Testing

The nominal pressure rating of a VITALFLEX® can vary according to type, material and size. The pressure can be affected by factors such as temperature, pulsation or shock conditions and bending stresses. To avoid distortion of the convolutions of the hose, the maximum test pressure quoted in the literature must not be exceeded. If requested all hoses can be tested to 1½ times the customers stated working pressure, provided that this does not exceed the stated maximum test pressure.

Applicable Standards

If required your hoses can be manufactured for use with gas and water.
 Corrugated Metal Hoses: ISO 10380
 AGA Approved: AS 4631 (upon request)
 Watermark Approved: WMTS 520 (upon request)
 Welding Compliant: AS 4041- Class 1 (upon request)
 Seismic Rated: AS 1170 (upon request)
 Fire Protection Systems (upon request)

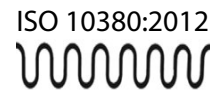

Convolution Profile

Annular



Omega / Braided Braid



High Pressure



Monel



Stainless Steel Hose - Covers and Liners

Covers

To protect the VITALFLEX® from unusual external abuse you can use different armours and covers such as: stainless steel interlock, heat shrink, lay-flat, scuff guarding, fire sleeve, fibre glass tape, PVC, rubber, wire spring-guard and rope lag cover. Refer to Cover Section Page 277 for more information

Silicone Coated Fibreglass Sleeve

Size : 6mm to 130mm
Material : Silicone



PVC Covering

Size : 1.6mm to 125.0mm
Material : Polyolefin



Wire Spring Guard

Size : 20mm to 100mm
Material : 316/304 Stainless Steel, Galvanised



Rope Lag

Size : 6mm to 48mm
Material : Sisal Rope



Wire Bend Restrictor

Size : 20mm to 100mm
Material : 316/304 Stainless Steel, Galvanised



Hose Floats

Size : 10mm - 130mm Hose O.D.
Material : Polyethylene

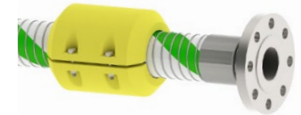

Pigstail

Size : 7mm to 99mm I.D.
Material : HPDE (High Density Polyethylene)



Bird & Rodent Proofing Briad

Size : 6mm to 150mm
Material : 316/304 Stainless Steel



Whipsock

Size : 14mm to 180mm
Material : 316/304 Stainless Steel, Galvanised



Rawhide

Size : 22.9mm to 93.0mm
Material : Nylon



Stainless Steel Interlock Cover

Size : 3/4" - 12"
Material : 304 Stainless Steel



Ball Joint Armor

Size : 1" - 6"
Material : Stainless Steel, Galvanised



Layflat

Size : 20mm to 200mm I.D.
Material : PVC with low pressure stability

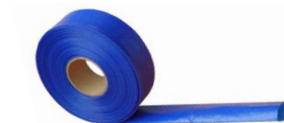

Hose Handling Sling

Size : 4" - 12" Hose Dia.
Material : 100% nylon webbing



Liners

The most common liner used in a VITALFLEX® is a metal interlock hose. The liner will allow a smooth flow rate whilst maintaining limited flexibility. The interlock will partially reduce the bend radius and inside diameter of the corrugated hose. The smooth liners reduce associated noise. Another alternative liner is braid which doesn't reduce the bend radius of the hose.

Interlock Liner

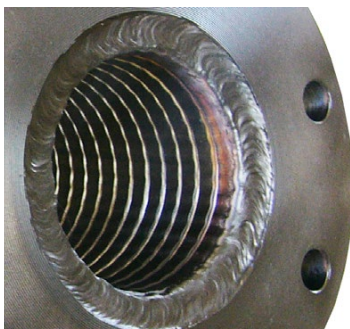

Braid Liner

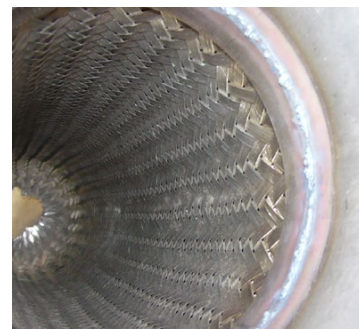

Calculating Hose Length

Minimum Bend Radius Occurs at Offset Position

The moving end is free to move "out of line" from neutral position.

To find the live hose length:

$$L = \sqrt{6(RT) + T^2}$$

$$L_p = \sqrt{L^2 - T^2}$$

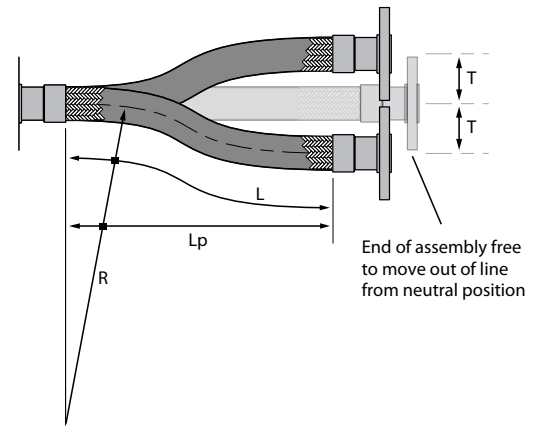

Minimum Bend Radius Occurs at In Line Position

The moving end of the hose is restricted to move only up and down in line as the hose crosses neutral position.

To find the live hose length:

$$L = \sqrt{20(RT)}$$

$$L_p = \sqrt{L^2 - T^2}$$

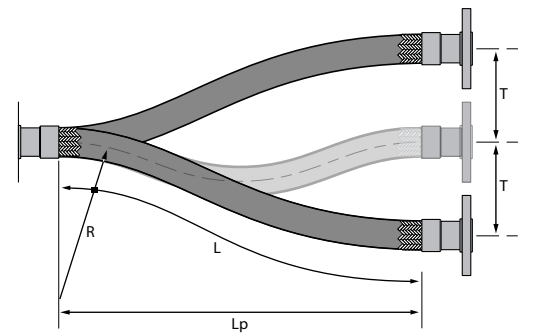

Horizontal Movable Pipe System

$$L = 4R + 1.57T$$

$$H_1 = 1.43R + 0.79T$$

$$H_2 = 1.43R + 0.5T$$

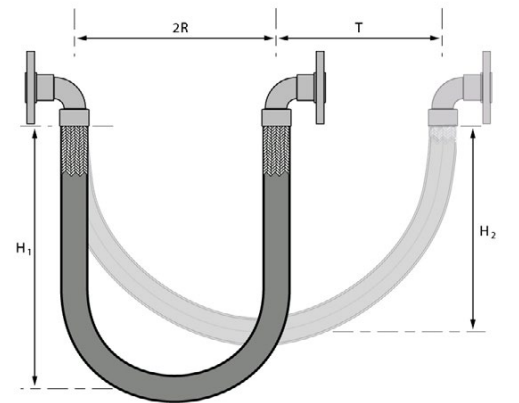

Vertical Movable Pipe System

$$L = 4R + \frac{T}{2}$$

$$H_1 = 1.43R + \frac{T}{2}$$

L = Live Hose Length (mm)

R = Minimum Dynamic Bend Radius for Constant Flexing (mm)

T = Total Travel (mm)

H1 = Hang Length of the Loop (mm)

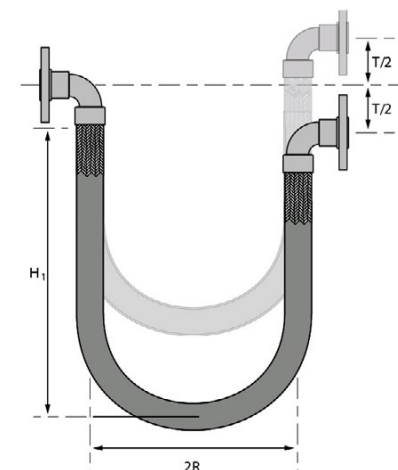

Installation Precautions

Prior to Installation

1. Examine the hose for any obvious damage. IF THE HOSE IS DAMAGED, DO NOT USE. Examples of damage may include slices to the cover, kinks, broken braid, and crushing of the hose (can reduce life and pressure rating).

2. Review application to ensure proper selection of hose has been made by examining materials, pressures, chemical compatibility, temperature and environment.

3. Hose movement should be restricted to a SINGLE PLANE (Drawing A) to minimize the resultant twisting (torque). Note: The flexing plane should also be the plane in which the bending occurs. Excessive bending will induce stress fatigue (Drawing B).

4. Axial movement should be eliminated. The hose should not be stretched or compressed along its longitudinal axis when installed in-line (Drawing C).

Installation

Never use hose below minimum bend radius (Drawing D). Bend radius (measured to inside radius of fluoropolymer-lined hose and centre line for the VITALFLEX®) are given for individual products and sizes (consult factory for specific data). These values represent the minimum bend radius with which the hose can be properly installed. If these values are not maintained, the hose can fail prematurely.

Note: In some cases, vacuum and pressure ratings are based on not exceeding 2% minimum bend radius (consult factory for specific hose ratings).

Do not allow severe bends (Drawing E). Severe bends can cause kinking in a hose or overstress the assembly/material, resulting in damage and ultimate failure. If severe bends cannot be avoided, use elbows designed to accommodate the direction change.

Do not twist (torque) assembly along centre line during installation. The likelihood of leakage/failure increases for hoses that are twisted (torqued) during assembly. The proper use of floating flanges and swivel-type fittings (i.e., JIC) can eliminate improper twisting.

Nominal Hose Size

1/2"	1"	1 1/2"	2"	3"	4"	5"	6"
10	10	15	25	40	30	60	75

Torque (ft.-lbs.)

• For accurate tightening a torque wrench is HIGHLY recommended. If a flange leak occurs on one side of a properly torqued flange, the bolts should not be over-torqued. Instead loosen the bolts on the non-leaking side the same amount you tighten the bolts on the leaking side.

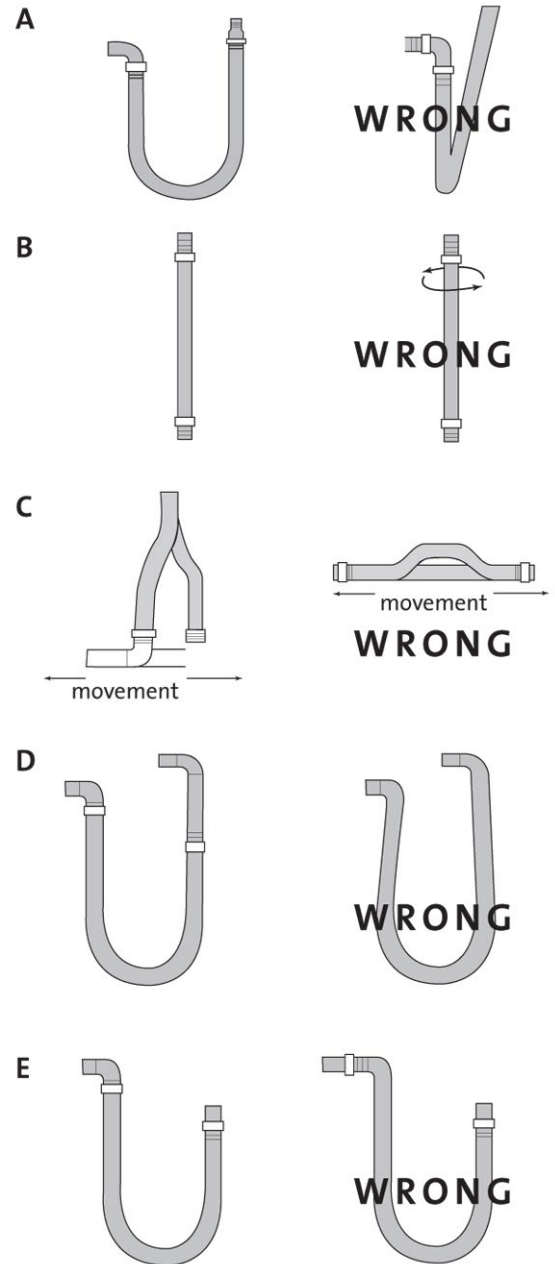

Bolt Torque Sequence

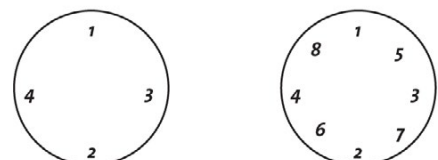

Velocity in Metal Hose

When a gas or liquid is conveyed in a VITALFLEX® assembly and it exceeds the limits, resonant vibration can occur. Resonance may cause very rapid failure of the assembly. VITALFLEX® hose should not exceed 150 ft./sec for gas applications and 75ft./sec. for liquids. In those applications where product velocities exceed the limits, a revision of the assembly design might include:

- 1) Addition of an interlocked metal hose liner.
- 2) An increase in the corrugated hose I.D.
- 3) A combination of the above.

Pressure Drop

Pressure drop in a piping system is often a concern of the designer. Compared to rigid pipe, there is always a greater pressure drop in corrugated metal hose. The following graphics are offered as aids in estimating pressure drop in corrugated hose conveying water and air. The values derived are approximate and apply only to straight line installations. Bends and fittings in the hose assembly can increase the pressure drop.

For a rough estimate, it can be assumed that the pressure loss in corrugated hoses in the turbulence zone is around 150% higher than in new welded steel pipes. I.e. the diameter of a corrugated hose would have to be increased by 20% to equal the pressure loss of steel pipe. In the high-velocity zone, corrugated hoses are around 450% higher due to the marked vortex activities; in this case, a diameter increase of 41% would be necessary.

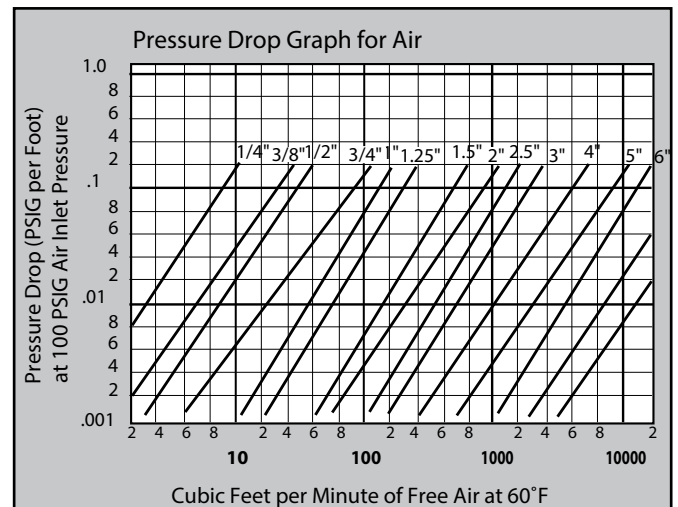

For air inlet pressures other than 100 psig:
 $PD = PD @ 100 \text{ psig} \left(\frac{100 + 14.7}{P + 14.7} \right)$



Water Pressure Loss & Vibration Information

Water Pressure loss

VITALFLEX® hoses are used for conveying of substances of different consistency (gaseous, liquid or solid). One of the important factors to consider in designing systems that implement metal hoses, is the loss of pressure. Due to its profile the pressure loss in corrugated hoses is significantly higher than in steel pipes – almost 100%, and about 20% to 25% higher for the stripwound hoses.

To find out pressure loss over a certain length of hose we can use Pressure Loss graph below – for example: we need to calculate the pressure loss in 85 feet long 2" Corrugated Hose (which transfers water) with Flow Rate been 1400 cubic feet per hour. By using calculator below we find that 1400 ft³/hour. corresponds to 175 gal/min. Then we plot the 175 gpm on the X-axis of the chart below until we "hit" the line for 2" hose ID, then by going over horizontally to the Y-axis, we find that Pressure Loss per foot of hose will be about 3.7 psi. So that the total pressure drop over the hose length will be 314.5 psi (3.7 x 85).

Keep in mind that if you transfer gaseous substance through the hose then you need to find the ratio of the density of gas over the density of water and adjust the pressure drop respectively. For example if you transfer natural gas (density = 0.050 lb/ft³) and knowing that water density = 62.4 lb/ft³ we can find out the pressure drop as the following: $3.7 \times (0.050/62.4) = 0.0030$ psi/ft or 0.255 psi for entire length of hose (85 x 0.003).

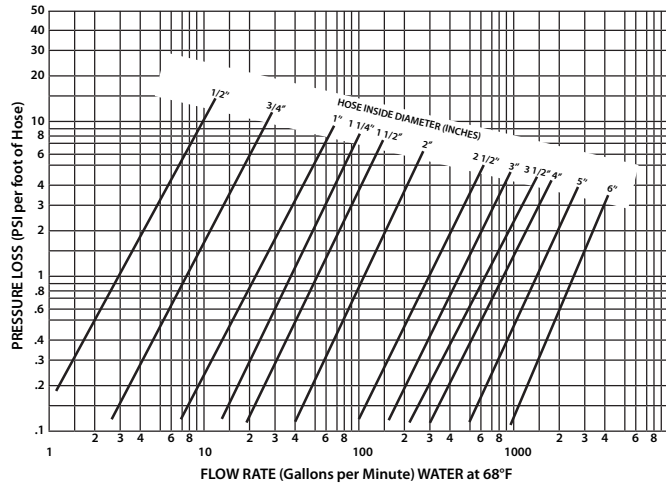

Vibration information and graph

The inherent flexibility of corrugated hose plus the dampening effect of the wire braid combine to create the excellent vibration isolation qualities of corrugated metal hose. The graph below defines the combination of amplitudes and frequencies considered to be normal industrial vibration.

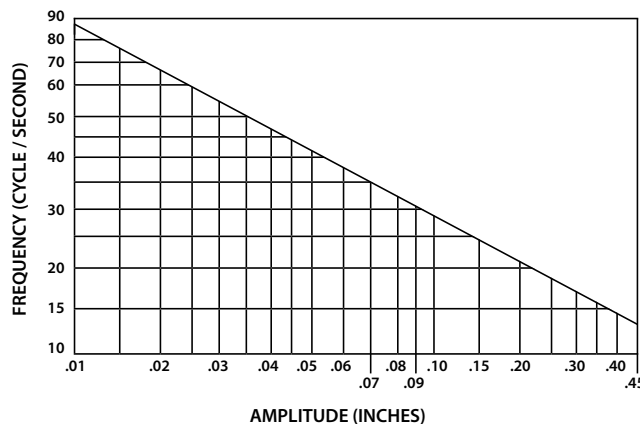

Jacketed Hose

Vitalflex® Jacketed Hose

A Jacketed Hose assembly consists of a “hose within a hose.” An inner or primary media conveying hose is enclosed or jacketed by a larger diameter hose. The hoses are joined at each end by specially designed fittings so that there is no media pathway between the two hoses.

Jacketed assemblies are often specified when the primary media must be kept at either an elevated or cryogenic temperature. Steam is often circulated through the jacket hose to keep a viscous material in the inner hose hot and easily conveyed. A vacuum can also be pulled on the jacket hose to insulate cryogenic liquids being conveyed in the inner hose.

The media typically is steam, hot oil or hot water to raise the temperature of the fluid moved in the internal hose. Also cold products such as liquid helium or nitrogen can be used to lower the temperature of the fluid with-in the internal hose.



The specialist hose design can also be used to contain hazardous medium in the event of a rupture. The outer hose will capture any medium that leaks from the inner hose preventing any safety or environmental issues. Sensors can be installed on the ports of the outer hoses to analyse any changes in pressure or gas detection.

Following Applications:

- Heated processes
- Rail car and tank truck loading/unloading
- Marine transfer
- Flexible connections to vibrating equipment
- To relieve pump housing stresses
- Hazardous material piping system using an alarmed vacuum jacket
- Safety barrier for toxic processes
- Leak detection systems
- Liquified food transfer systems
- Chlorine transfer
- Cryogenics (fast freezing)

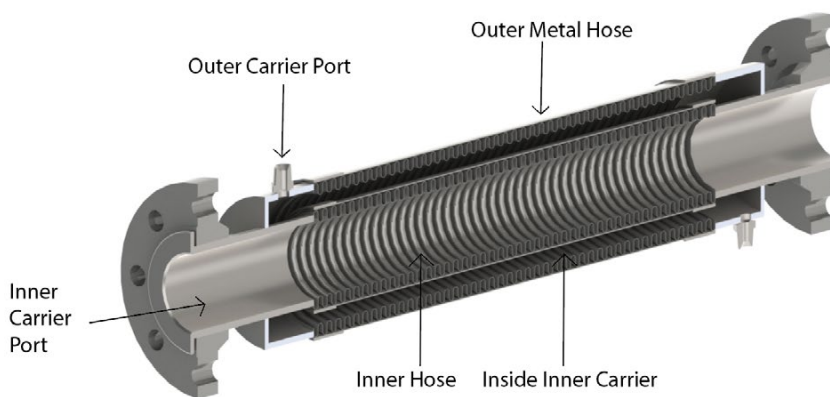

Inner hose nb size	6mm	10mm	12mm	19mm	25mm	32mm	38mm	50mm	65mm	75mm	100mm	125mm	150mm	200mm
Outer hose nb size	12mm	19mm	25mm	32mm	38mm	50mm	65mm	75mm	100mm	150mm	150mm	200mm	200mm	250mm
Inner hose max pressure (kPa)	16270	11299	8445	7129	5487	4136	3840	3930	2826	2310	1654	1316	1137	1643

Seismic Joints

Seismic Joints and Expansion Loops

Model name: VITALFLEX-V and VITALFLEX-U

VITALFLEX® seismic joints and expansion loops are engineered to account for the cumulative movement(s) in piping systems. The VITALFLEX® joint have been designed to counter thermal expansion/contraction, offset and rotation.

Piping used in locations subject to seismic conditions have their own set of unexpected random movements. The random motion common to earthquakes, requires that seismic expansion joints be capable of movement in any direction and are able to withstand the acceleration forces.

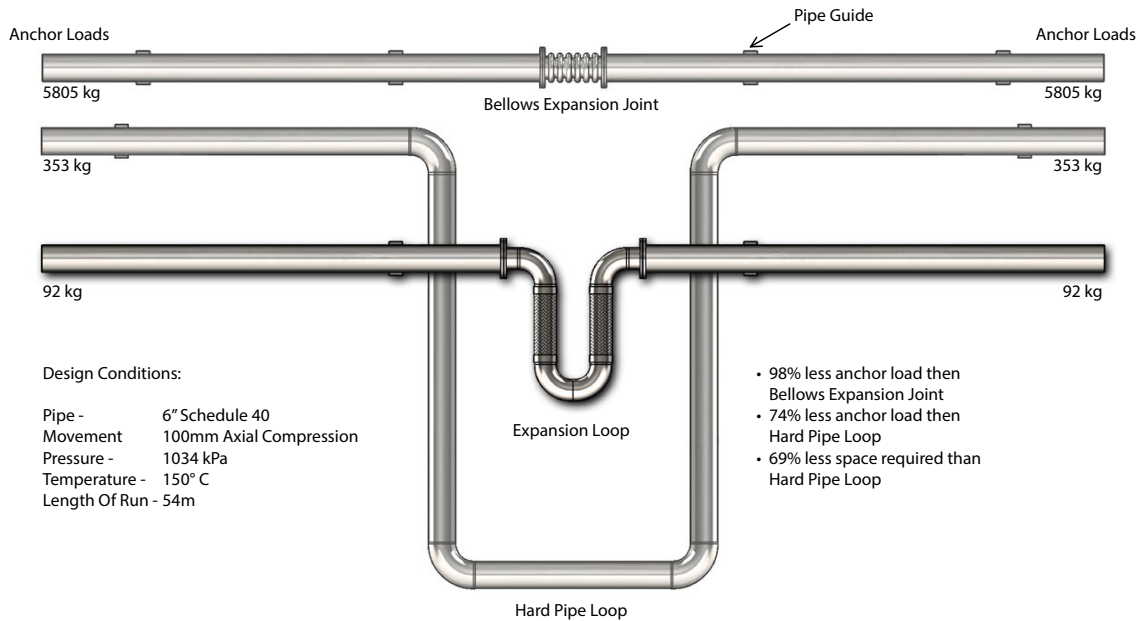

Significant cost and safety benefits found in Pacific Hoseflex seismic expansion joints.

- It is an inexpensive alternative to dual-tied bellows expansion joints and ball joints
Metal Hoses: ISO 10380 Corrugated
- During an earthquake, it protects equipment by allowing boilers, chillers, fan-coil units and other systems to move independently from buildings such as hospitals, high rises and stadiums Seismic
Rated: AS 1170 (upon request)
- Installation at the connection point, prevents nozzles from cracking or shearing off
- A break in the gas pipe work could start a fire and cause vast damage to the entire building. This Australian Gas Approval (AGA) certified seismic expansion joint will compensate for the movement that occurs during any seismic activity such as an earthquake
AGA Approved: AS 4631 (upon request)
- Designed for potable water applications the VITALFLEX® can be Watermark certified in accordance with WMTS 520 joint



See Expansion Joint catalogue for data sheets Page 84

Stainless Steel Hose

VITALFLEX® - Annular



Part No.: SS0-A Tube Only / SS1-A Tube and Single Braid / SS2-A Tube and Double Braid
Construction: Annular / Close Pitch
Tube Available: 304 / 316 Stainless Steel
Braid Available: 304 / 316 Stainless Steel
Size Available: 1/4" - 4"
Max Temp: -276°C to 700°C

Low | Med | High

Flexibility

Cycle Life

Pressure Rating

Chemical Resistance

Wall Thickness

Construction



Applicable Standards:

Corrugated Metal Hoses: ISO 10380

AGA Approved: AS 4631 (upon request)

Watermark Approved: WMTS 520 (upon request)

Welding Compliant: AS 4041- Class 1 (upon request)

Seismic Rated: AS 1170 (upon request)

Fire Protection Systems (upon request)

Temperature Correction Factor ISO 10380 (316L)

-200	-150	-100	-50	0	20	50	100	150	200	250	300	350	400	450	500	550	600	650	700
1.0	1.0	1.0	1.0	1.0	1.0	0.93	0.83	0.72	0.66	0.62	0.59	0.56	0.55	0.53	0.51	0.50	0.50	0.19	0.1

Annular

Nominal Dia.		Outside Dia. (mm)			Weight (Kg/m)			Min. Bend Radius(mm)		Working Pressure (kPa)			Burst Pressure (kPa)		
mm	inch	SS0	SS1	SS2	SS0	SS1	SS2	Static	Dynamic	SS0	SS1	SS2	SS0	SS1	SS2
6	1/4"	9.60	10.80	12.10	0.13	0.25	0.39	28	80	496	16270	19523	1985	65079	78095
10	3/8"	14.50	15.50	16.70	0.19	0.37	0.53	38	129	496	11299	13560	1985	45197	54242
12	1/2"	16.70	18.00	19.72	0.34	0.50	0.68	45	139	496	8445	10134	1985	33780	40536
20	3/4"	26.70	28.00	29.20	0.58	0.88	1.18	67	167	296	7128	8555	1186	28513	34221
25	1"	32.20	33.70	34.90	0.79	1.12	1.46	84	190	296	5487	6583	1186	21950	26335
32	1 1/4"	41.20	42.60	43.80	1.13	1.60	2.05	105	260	296	4136	4963	1186	16545	19854
40	1 1/2"	49.50	50.90	52.10	1.25	1.84	2.43	130	298	193	3840	4605	772	15359	18420
50	2"	60.30	61.70	62.90	1.34	2.27	3.20	160	318	193	3930	4715	772	15718	18862
65	2 1/2"	84.00	85.30	88.30	1.76	2.78	3.83	203	500	100	2826	4521	400	11307	18084
80	3"	98.00	100.30	102.30	1.81	2.99	4.19	229	558	90	2310	3696	400	9240	14784
100	4"	124.00	126.30	128.30	2.52	4.01	5.50	330	685	80	1654	2646	320	6618	10584

Part Number Key:

SSABC-D-E

A: Braid quality required 0 = no braid 1 = Single Braid 2 = Double Braid 3 = Triple Braid
B: Tube Material 6S = 316 Tube 4S = 304 Tube
C: Braid Material 6S = 316 Braid 4S = 304 Braid
D: Hose Type A = Annular, B = Braided Braid, O = Omega
E: Hose Size 06 = 1/4", 10 = 3/8", 12 = 1/2", 20 = 3/4", 25 = 1", 32 = 1-1/4", 40 = 1-1/2"

Example: SS16S4S-A-40 = 1-1/2" Single Braided Annular Stainless Steel Hose, 316 Tube and 304 Braid

Example: SS26S6S-A-50 = 2" Double Braided Annular Stainless Steel Hose, 316 Tube and 316 Braid

1
2
3
4
5
6
7
8
9

STAINLESS STEEL HOSE

Stainless Steel Hose

VITALFLEX® - Omega / Braided Braid



Omega Part No.: SS0-O Tube Only / SS1-O Tube and Single Braid / SS2-O Tube and Double Braid

Braided Braid Part No.: SS0-B Tube Only / SS1-B Tube and Single Braid / SS2-B Tube and Double Braid

Construction: Omega / Close Pitch

Tube Available: 304 / 316 Stainless Steel

Braid Available: 304 / 316 Stainless Steel

Size Available: 5" - 20"

(Larger sizes upon Request)

Max Temp: -276°C to 700°C

Low | Med | High

Flexibility

Cycle Life

Pressure Rating

Chemical Resistance

Wall Thickness

Construction



Applicable Standards:

Corrugated Metal Hoses: ISO 10380

AGA Approved: AS 4631 (upon request)

Watermark Approved: WMTS 520 (upon request)

Welding Compliant: AS 4041- Class 1 (upon request)

Seismic Rated: AS 1170 (upon request)

Fire Protection Systems (upon request)

Temperature Correction Factor

-200	-150	-100	-50	0	20	50	100	150	200	250	300	350	400	450	500	550	600	650	700
1.0	1.0	1.0	1.0	1.0	1.0	0.93	0.83	0.72	0.66	0.62	0.59	0.56	0.55	0.53	0.51	0.50	0.50	0.19	0.1

Omega

Nominal Dia.		Outside Dia. (mm)			Weight (Kg/m)			Min. Bend Radius (mm)		Working Pressure (kPa)			Burst Pressure (kPa)		
mm	inch	SS0	SS1	SS2	SS0	SS1	SS2	Static	Dynamic	SS0	SS1	SS2	SS0	SS1	SS2
125	5"	151	155	159	2.8	5	7.2	500	1200	200	1610	2455	800	6440	9820
150	6"	176	184	188	3.8	6.6	9.4	600	1500	200	1610	2455	800	6440	9820
200	8"	238	245	250	6.7	12	17.3	800	2000	200	1250	1975	800	5000	7900
250	10"	292	303	308	10.6	17	25	1000	2200	200	1022	1597	800	4088	6388
300	12"	345	365	370	17.1	20	26.5	1200	2500	200	815	1280	800	3260	5120
350	14"	400	415	420	20	24	29	1400	3000	200	805	1207	800	3220	4828
400	16"	460	465	470	22.8	28	33	1600	3500	200	600	1000	800	2400	4000
450	18"	500	502	504	40	50	60	2250	4500	100	500	800	400	2000	3200
500	20"	575	577	579	46	58	70	2500	5000	100	500	800	400	2000	3200

Higher pressure hoses can be designed on request

Braided Braid (High Pressure)

Nominal Dia.		Outside Dia. (mm)			Weight (Kg/m)			Min. Bend Radius (mm)		Working Pressure (kPa)			Burst Pressure (kPa)		
mm	inch	SS0	SS1	SS2	SS0	SS1	SS2	Static	Dynamic	SS0	SS1	SS2	SS0	SS1	SS2
125	5"	151	158	165	2.8	5	7.2	500	1200	200	1935	2902	800	7740	11608
150	6"	176	187	194	3.8	7	9.4	600	1500	200	1800	2700	800	7200	10800
200	8"	238	248	256	6.7	12.5	18	800	2000	200	1613	2578	800	6452	10312
250	10"	292	306	314	10.6	18.1	25.8	1000	2200	200	1211	1937	800	4844	7748
300	12"	345	368	376	17.1	21	28	1200	2500	200	910	1456	800	3640	5824
350	14"	400	418	426	20	25	30	1400	3000	200	885	1416	800	3540	5664
400	16"	460	468	476	22.8	30.2	38	1600	3500	200	780	1170	800	3120	4680
450	18"	500	505	510	40	52	64	2250	4500	100	600	900	400	2400	3600
500	20"	575	580	585	46	60	74	2500	5000	100	550	825	400	2200	3300

Higher pressure hoses can be designed on request

Stainless Steel Hose

VITALFLEX® - High Pressure



Part No.: SS0-HP Tube Only / SS1-HP Tube and Single Braid / SS2-HP Tube and Double Braid
Construction: Annular / Close Pitch / Heavy Wall
Tube Available: 304 / 316 / 321 Stainless Steel
Braid Available: 304 / 316 Stainless Steel
Size Available: 1/4" - 6"
Max Temp: -276°C to 700°C

	Low	Med	High
Flexibility	<input type="radio"/>	<input checked="" type="radio"/>	<input type="radio"/>
Cycle Life	<input type="radio"/>	<input type="radio"/>	<input checked="" type="radio"/>
Pressure Rating	<input type="radio"/>	<input type="radio"/>	<input checked="" type="radio"/>
Chemical Resistance	<input type="radio"/>	<input type="radio"/>	<input checked="" type="radio"/>
Wall Thickness	<input type="radio"/>	<input type="radio"/>	<input checked="" type="radio"/>

Construction



Applicable Standards:

Corrugated Metal Hoses: ISO 10380
 AGA Approved: AS 4631 (upon request)
 Watermark Approved: WMTS 520 (upon request)

Welding Compliant: AS 4041- Class 1 (upon request)
 Seismic Rated: AS 1170 (upon request)
 Fire Protection Systems (upon request)

Temperature Correction Factor

-200	-150	-100	-50	0	20	50	100	150	200	250	300	350	400	450	500	550	600	650	700
1.0	1.0	1.0	1.0	1.0	1.0	0.93	0.83	0.72	0.66	0.62	0.59	0.56	0.55	0.53	0.51	0.50	0.50	0.19	0.1

Nominal Dia.		Outside Dia. (mm)			Weight (Kg/m)			Min. Bend Radius (mm)		Working Pressure (kPa)			Burst Pressure (kPa)		
mm	inch	SS0	SS1	SS2	SS0	SS1	SS2	Static	Dynamic	SS0	SS1	SS2	SS0	SS1	SS2
6	1/4"	12.7	14.5	16.3	0.13	0.25	0.39	25.4	127	1242	17678	28283	4968	70712	113132
10	3/8"	17	18.8	20.6	0.19	0.37	0.54	31.8	139.7	690	10357	16567	2760	41428	66268
12	1/2"	20.8	23.4	25.9	0.58	0.94	1.29	38.1	203.2	552	15139	24219	2208	60556	96876
20	3/4"	30.7	33.3	35.8	0.71	1.18	1.64	50.8	203.2	483	9046	14476	1932	36184	57904
25	1"	38.1	40.6	43.2	1.18	1.79	2.40	76.2	228.6	276	7376	11799	1104	29504	47196
32	1 1/4"	47	50	53.3	1.52	2.47	3.42	82.6	254	228	7659	12254	912	30636	49016
40	1 1/2"	55.1	58.4	61.7	2.02	3.14	4.26	82.6	254	138	5989	9577	552	23956	38308
50	2"	63.8	67.1	70.1	2.38	3.81	5.24	136.7	292.1	104	5589	8942	416	22356	35768
65	2 1/2"	82	85.3	88.6	2.98	4.64	4.91	177.8	609.6	69	3988	6383	276	15952	25532
80	3"	96	99.3	102.4	4.42	6.58	8.74	190.5	711.2	69	3726	5962	276	14904	23848
100	4"	122.2	125.2	128.3	4.61	6.77	8.93	508	1016	55	2298	3678	220	9192	14712
150	6"	174.5	180.3	186.2	5.73	9.60	13.47	609.6	2413	35	1835	2933	140	7340	11732

Applications



1 2 3 4 5 6 7 8 9
 STAINLESS STEEL HOSE

Stainless Steel Hose

VITALFLEX® - Ultra High Pressure



Part No.: SS0-UHP Tube Only / SS1-UHP Tube and Single Braid / SS2-UHP Tube and Double Braid

Construction: Annular / Close Pitch / Heavy Wall

Tube Available: 316 Stainless Steel

Braid Available: 304 / 316 Stainless Steel

Size Available: 1/4" - 2"

Max Temp: -276°C to 700°C

Low | Med | High

Flexibility

Cycle Life

Pressure Rating

Chemical Resistance

Wall Thickness

Construction

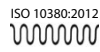
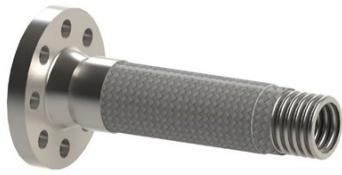

Applicable Standards:

Corrugated Metal Hoses: ISO 10380

AGA Approved: AS 4631 (upon request)

Watermark Approved: WMTS 520 (upon request)

Welding Compliant: AS 4041- Class 1 (upon request)

Seismic Rated: AS 1170 (upon request)

Fire Protection Systems (upon request)

Temperature Correction Factor

-200	-150	-100	-50	0	20	50	100	150	200	250	300	350	400	450	500	550	600	650	700
1.0	1.0	1.0	1.0	1.0	1.0	0.93	0.83	0.72	0.66	0.62	0.59	0.56	0.55	0.53	0.51	0.50	0.50	0.19	0.1

Nominal Dia.		Outside Dia. (mm)			Weight (Kg/m)			Min. Bend Radius (mm)		Working Pressure (kPa)			Burst Pressure (kPa)		
mm	inch	SS0	SS1	SS2	SS0	SS1	SS2	Static	Dynamic	SS0	SS1	SS2	SS0	SS1	SS2
6	1/4"	12.7	14.7	16.3	0.30	0.42	0.54	304.8	152.4	1241	18988	30378	4964	75953	121513
10	3/8"	17.0	19.1	21.1	0.46	0.64	0.82	304.8	152.4	689	13245	21188	2758	52979	84750
12	1/2"	20.8	23.4	25.9	0.60	0.86	1.13	355.6	177.8	552	13748	22008	2206	54993	88032
20	3/4"	31.0	34.0	37.1	0.97	1.37	1.77	381	190.5	483	13748	22008	1931	54993	88032
25	1"	38.6	41.9	45.0	1.52	2.20	2.89	406.4	203.2	276	11025	17637	1103	44099	70547
32	1 1/4"	47.0	50.0	53.1	2.32	3.01	3.69	457.2	228.6	172	9080	14527	689	36322	58109
40	1 1/2"	55.6	58.7	61.7	2.99	3.94	4.91	482.6	241.3	138	7322	1107	552	29289	46829
50	2"	63.8	67.1	70.4	3.62	4.72	5.82	609.6	304.8	103	5805	9280	414	23222	37121

Applications



9
8
7
6
5
4
3
2
1

STAINLESS STEEL HOSE

Stainless Steel Hose

VITALFLEX® - Extreme High Pressure



Part No.: SS3-EHP Tube and Triple Braid / SS4-EHP Tube and Quadruple Braid

Construction: Annular / Close Pitch / Heavy Wall

Tube Available: 316 Stainless Steel

Braid Available: 316 Stainless Steel

Size Available: 3" - 4"

Max Temp: -276°C to 700°C

Low | Med | High

Flexibility	<input type="radio"/>	<input type="radio"/>	<input type="radio"/>
Cycle Life	<input type="radio"/>	<input type="radio"/>	<input type="radio"/>
Pressure Rating	<input type="radio"/>	<input type="radio"/>	<input type="radio"/>
Chemical Resistance	<input type="radio"/>	<input type="radio"/>	<input type="radio"/>
Wall Thickness	<input type="radio"/>	<input type="radio"/>	<input type="radio"/>

Construction



Applicable Standards:

Corrugated Metal Hoses: ISO 10380

AGA Approved: AS 4631 (upon request)

Watermark Approved: WMTS 520 (upon request)

Welding Compliant: AS 4041- Class 1 (upon request)

Seismic Rated: AS 1170 (upon request)

Fire Protection Systems (upon request)

Temperature Correction Factor

-200	-150	-100	-50	0	20	50	100	150	200	250	300	350	400	450	500	550	600	650	700
1.0	1.0	1.0	1.0	1.0	1.0	0.93	0.83	0.72	0.66	0.62	0.59	0.56	0.55	0.53	0.51	0.50	0.50	0.19	0.1

Nominal Dia.		Braids	Outside Dia.	Weight	Min. Bend Radius (mm)		Working Pressure	Burst Pressure
mm	inch				Static	Dynamic		
80	3"	3	107.2	12.95	812.8	2133.6	8618	34474
100	4"	4	133.9	15.60	1320.8	2444.8	8618	34474

Applications



1 2 3 4 5 6 7 8 9

STAINLESS STEEL HOSE

Stainless Steel Hose

VITALFLEX® - Monel



Part No.: SS0-M Tube and Braid / SS1-M Tube and Single Braid / SS2-M Tube and Double Braid

Construction: Annular / Close Pitch / Heavy Wall

Tube Available: 400 Monel

Braid Available: 400 Monel

Size Available: 1/4" - 3"

Max Temp: -276°C to 700°C

Low | Med | High

Flexibility

Cycle Life

Pressure Rating

Chemical Resistance

Wall Thickness

Construction



Applicable Standards:

Corrugated Metal Hoses: ISO 10380

AGA Approved: AS 4631 (upon request)

Watermark Approved: WMTS 520 (upon request)

Welding Compliant: AS 4041- Class 1 (upon request)

Seismic Rated: AS 1170 (upon request)

Fire Protection Systems (upon request)

Chlorine Institute Pamphlet 6. Appendix A

Temperature Correction Factor

-150	-100	-50	0	20	70	150	200	250	300	350	400	450
1.0	1.0	1.0	1.0	1.0	1.0	0.93	0.89	0.86	0.83	0.81	0.78	0.78

Nominal Dia.		Outside Dia. (mm)			Weight (Kg/m)			Min. Bend Radius (mm)		Working Pressure (kPa)			Burst Pressure (kPa)		
mm	inch	SS0	SS1	SS2	SS0	SS1	SS2	Static	Dynamic	SS0	SS1	SS2	SS0	SS1	SS2
3	1/4"	12.7	14.7	16.7	0.13	0.28	0.43	25.4	127	922	12975	20753	3688	51896	83033
12	1/2"	20.8	22.8	24.8	0.58	0.93	1.29	38.1	230.2	441	4833	7729	1644	19339	30909
20	3/4"	30.7	32.7	35.0	0.71	1.17	1.63	50.8	230.2	386	3736	5977	1544	14968	23917
25	1"	38.1	40.1	42.1	1.17	1.48	1.78	76.2	228.6	220	3199	5115	880	12803	20477
40	1 1/2"	55.6	57.6	59.6	1.24	1.90	2.55	101.6	304.8	110	2275	3640	440	9114	14561
50	2"	63.7	65.7	67.8	1.54	2.55	3.57	127	381	82	2178	3488	328	8728	13941
80	3"	96.0	98.5	101.0	1.80	3.03	4.26	228.6	558.8	55	1358	2164	220	5433	8673

* Monel hoses are manufactured and tested and are suitable for dry chlorine service which meets The Chlorine Institute-Piping System for Dry Chlorine Standard - Pamphlet 6 Edition 15

Alternative products:

Refer to Chlorine Transfer PTFE - Page 19

Applications



9
8
7
6
5
4
3
2
1

STAINLESS STEEL HOSE

Pump Connectors

VITALFLEX® - Table 'E' M/S Fixed Flanges



Part No.: SSPC
Construction: Omega / Close Pitch
Profile: Medium Flexibility / Medium Pressure
Tube Available: 304 / 316 Stainless Steel
Braid Available: 304 / 316 Stainless Steel
Size Available: 2" - 8"
(Larger sizes upon Request)
Max Temp: -276°C to 700°C

	Low	Med	High
Flexibility	<input type="radio"/>	<input checked="" type="radio"/>	<input type="radio"/>
Cycle Life	<input type="radio"/>	<input type="radio"/>	<input checked="" type="radio"/>
Pressure Rating	<input type="radio"/>	<input checked="" type="radio"/>	<input type="radio"/>
Chemical Resistance	<input type="radio"/>	<input type="radio"/>	<input checked="" type="radio"/>
Wall Thickness	<input type="radio"/>	<input checked="" type="radio"/>	<input type="radio"/>

Construction

Vibration Eliminator / Pump Connector

Pump Connectors are flexible metal assemblies, primarily designed to isolate vibration from pumps on both the suction and discharge sides of the pump. They help to prevent damage caused by vibration, expansion and contraction. They accept thermal expansion and reduce piping stress due to minor misalignment. Constructed of stainless steel Omega corrugated metal and surrounded with a woven braid of high tensile stainless steel, these assemblies are flexible and are suitable to withstand high pressure and temperatures.

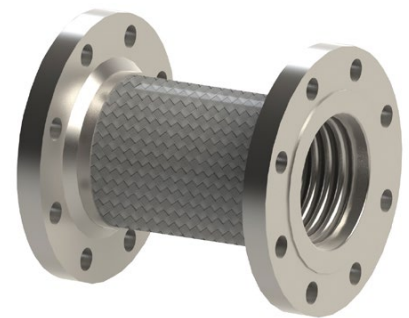

Applicable Standards:

Corrugated Metal Hoses: ISO 10380
 AGA Approved: AS 4631 (upon request)
 Watermark Approved: WMTS 520 (upon request)

Welding Compliant: AS 4041- Class 1 (upon request)
 Seismic Rated: AS 1170 (upon request)
 Fire Protection Systems (upon request)

Specifications

S/S Pump Connector – Table 'E' M/S Fixed Flanges				
Part Number	Size	Length	Working Pressure (kPa)	Burst Pressure (kPa)
SSPC-50	2"	150mm	2501	10004
SSPC-65	2 1/2"	150mm	2501	8004
SSPC-80	3"	150mm	2001	8004
SSPC-100	4"	150mm	1601	6406
SSPC-125	5"	150mm	1508	6032
SSPC-150	6"	150mm	1508	6032
SSPC-200	8"	200mm	1201	4804

Custom sizes, lengths and end connections available on request. Please contact Pacific Hoseflex for more information

Applications



Pump Connectors

VITALFLEX® - BSPT 304 S/S Hex Fixed Males



Part No.: SSPC

Construction: Omega / Close Pitch

Profile: Medium Flexibility / Medium Pressure

Tube Available: 304 / 316 Stainless Steel

Braid Available: 304 / 316 Stainless Steel

Size Available: 3/4" - 2"

(Larger sizes upon Request)

Max Temp: -276°C to 700°C

	Low	Med	High
Flexibility	<input type="radio"/>	<input checked="" type="radio"/>	<input type="radio"/>
Cycle Life	<input type="radio"/>	<input type="radio"/>	<input checked="" type="radio"/>
Pressure Rating	<input type="radio"/>	<input checked="" type="radio"/>	<input type="radio"/>
Chemical Resistance	<input type="radio"/>	<input type="radio"/>	<input checked="" type="radio"/>
Wall Thickness	<input type="radio"/>	<input checked="" type="radio"/>	<input type="radio"/>

Construction

Vibration Eliminator / Pump Connector

Pump Connectors are flexible metal assemblies, primarily designed to isolate vibration from pumps on both the suction and discharge sides of the pump. They help to prevent damage caused by vibration, expansion and contraction. They accept thermal expansion and reduce piping stress due to minor misalignment. Constructed of stainless steel Omega corrugated metal and surrounded with a woven braid of high tensile stainless steel, these assemblies are flexible and are suitable to withstand high pressure and temperatures.



Applicable Standards:

Corrugated Metal Hoses: ISO 10380

AGA Approved: AS 4631 (upon request)

Watermark Approved: WMTS 520 (upon request)

Welding Compliant: AS 4041- Class 1 (upon request)

Seismic Rated: AS 1170 (upon request)

Fire Protection Systems (upon request)

Specifications

S/S Pump Connector – BSPT 304 S/S Hex Fixed Males

Part Number	Size	Length	Working Pressure (kPa)	Burst Pressure (kPa)
SSPC-22643	3/4"	255mm	5003	200012
SSPC-22644	1"	255mm	4002	16008
SSPC-22645	1 1/4"	255mm	3502	14008
SSPC-22646	1 1/2"	305mm	3502	12008
SSPC-22647	2"	330mm	2501	10004

Custom sizes, lengths and end connections available on request. Please contact Pacific Hoseflex for more information

Applications

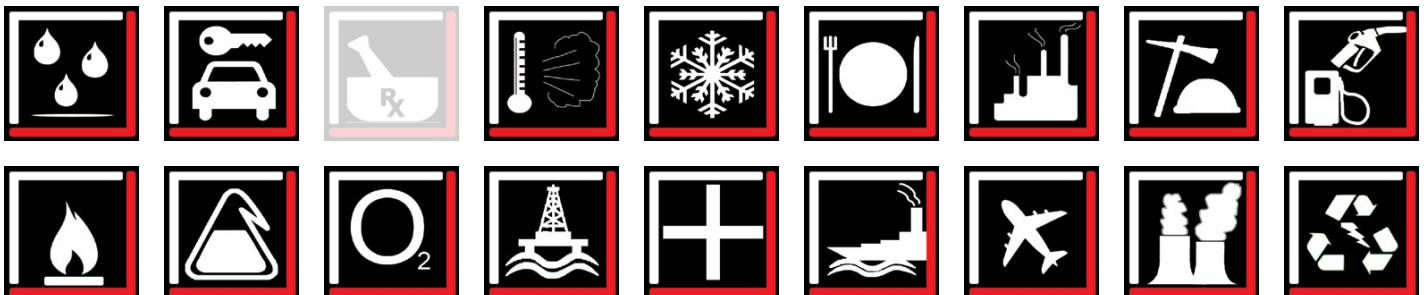

9
8
7
6
5
4
3
2
1

STAINLESS STEEL HOSE

Vitalflex Hose - UHP-SILVER SNAKE

Vitalflex® Ultra High Pressure Gas Cylinder Hose



Part No.: SS1-A Tube and Single Braid / SS2-A Tube and Double Braid
Construction: Heavy- Weight Mechanically formed Annular Hose
Tube Available: 304 / 316 Stainless Steel
Braid Available: 304 / 316 Stainless Steel
Size Available: 1/4"
Max Temp: -276°C to 700°C

	Low	Med	High
Flexibility	<input type="radio"/>	<input type="radio"/>	<input checked="" type="radio"/>
Cycle Life	<input type="radio"/>	<input type="radio"/>	<input checked="" type="radio"/>
Pressure Rating	<input type="radio"/>	<input type="radio"/>	<input checked="" type="radio"/>
Chemical Resistance	<input type="radio"/>	<input type="radio"/>	<input checked="" type="radio"/>
Wall Thickness	<input type="radio"/>	<input type="radio"/>	<input checked="" type="radio"/>

Construction

ISO 10380:2012

AS 4041
 Welding

Applicable Standards:
 Corrugated Metal Hoses: ISO 10380
 Welding Compliant: AS 4041- Class 1 (upon request)



Temperature Correction Factor ISO 10380 (316L)																				
-200	-150	-100	-50	0	20	50	100	150	200	250	300	350	400	450	500	550	600	650	700	
1.0	1.0	1.0	1.0	1.0	1.0	0.93	0.83	0.72	0.66	0.62	0.59	0.56	0.55	0.53	0.51	0.50	0.50	0.19	0.1	

Annular

Nominal Dia.		Outside Dia. (mm)		Weight (Kg/m)		Min. Bend Radius(mm)				Working Pressure (kPa)		Burst Pressure (kPa)	
mm	inch	SS1	SS2	SS1	SS2	Static SS1	Static SS1	Dynamic SS1	Dynamic SS1	SS1	SS2	SS1	SS2
6	1/4"	11.40	13.20	0.32	0.50	50	65	124	140	32000	40500	128000	162000



1 2 3 4 5 6 7 8 9

STAINLESS STEEL HOSE

Stainless Steel Hose

VITALFLEX® - Bitumen Hose - Convoluted



Construction: Annular / Close Pitch
Profile: Medium Flexibility / Medium Pressure
Tube Available: 304 / 316 Stainless Steel
Cover Optional: Fiberglass Sleeve, Rope Lag, Galvanised Armor Wire
Size Available: 2 1/2"
Max Temp: -276°C to 700°C

	Low	Med	High
Flexibility	<input type="radio"/>	<input checked="" type="radio"/>	<input type="radio"/>
Cycle Life	<input type="radio"/>	<input checked="" type="radio"/>	<input type="radio"/>
Pressure Rating	<input type="radio"/>	<input checked="" type="radio"/>	<input type="radio"/>
Chemical Resistance	<input type="radio"/>	<input checked="" type="radio"/>	<input type="radio"/>
Wall Thickness	<input type="radio"/>	<input checked="" type="radio"/>	<input type="radio"/>

Construction

Bitumen Hoses

- 2.5 to 3m – for most transfer in the field between sprayers and tankers
- 4 to 5m – for general storage facilities
- 6 to 7m for large storage facilities and areas in depots where access may be limited
- If a length excess of 7m is required, it is recommended that where possible, a combination of fixed pipe and a shorter length hose be used

Standards:

ADG-7
 AS 2475
 Corrugated Metal Hose: ISO 10380
 AAPA HSEtE Guide No. 7



Specifications

Nominal Dia.		Outside Dia. (mm)			Weight (Kg/m)			Min. Bend Radius (mm)		Working Pressure (kPa)			Burst Pressure (kPa)		
mm	inch	SS0	SS1	SS2	SS0	SS1	SS2	Static	Dynamic	SS0	SS1	SS2	SS0	SS1	SS2
63	2 1/2"	79	82	85	1.41	2.70	3.99	280	650	294	2001	4002	294	8004	16008

Alternative products:

Convoluted Rope Lagged - Page 49
 Bitumen Code Hose - Page 185
 Spray Bar specification - Page 39
 HYTAR Bitumen Fittings - Page 248



Applications



9
8
7
6
5
4
3
2
1

STAINLESS STEEL HOSE

Stainless Steel Hose - Convoluted Rope Lagged

VITALFLEX® - Convoluted Rope Lagged



Construction: Annular / Close Pitch
Profile: Medium Flexibility / Medium Pressure
Tube Available: 304 / 316 Stainless Steel
Cover: Three strand twisted sisal rope
Size Available: 6", 8" and 10"
Hose Max Temp: +200°C

	Low Med High
Flexibility	<input type="radio"/> <input checked="" type="radio"/> <input type="radio"/>
Cycle Life	<input type="radio"/> <input checked="" type="radio"/> <input type="radio"/>
Pressure Rating	<input type="radio"/> <input checked="" type="radio"/> <input type="radio"/>
Chemical Resistance	<input type="radio"/> <input checked="" type="radio"/> <input type="radio"/>
Wall Thickness	<input type="radio"/> <input checked="" type="radio"/> <input type="radio"/>

Construction

Standards:

ADG-7
 AS 2475
 Corrugated Metal Hose: ISO 10380
 AAPA HSEE Guide No. 7

Applications:

Dockside
 Heavy Duty Ship Unloading



Specifications

Nominal Dia.		Weight (Kg/m)			Min. Bend Radius(mm)		Working Pressure (kPa)			Burst Pressure (kPa)		
mm	inch	SS0	SS1	SS2	Static	Dynamic	SS0	SS1	SS2	SS0	SS1	SS2
150	6"	5.19	7.11	9.04	482	914	34	1137	1820	136	4550	7280
200	8"	8.31	14.13	19.99	508	1016	41	1643	2578	164	6440	10307
250	10"	10.17	19.30	28.44	635	1270	35	1585	2530	140	6329	10128

Alternative products:

Bitumen Hose Convoluted - Page 48

Applications



9
8
7
6
5
4
3
2
1

STAINLESS STEEL HOSE

Stainless Steel Hose - TTMA Drop Hose

VITALFLEX® - TTMA Drop Hose



Construction: Omega / Close Pitch
Profile: High Flexibility / Medium Pressure
Tube Available: 304 / 316 Stainless Steel
Cover Optional: Fibreglass Sleeve, Rope Lag, PVC, Galvanised Armor Wire
Size Available: 3" - 4"
(Larger sizes upon Request)
Max Temp: -276°C to 700°C

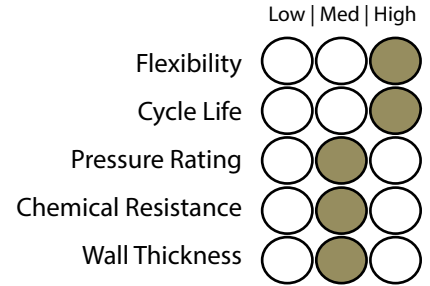

Construction

Drop Hose

Standard Lengths 1800mm and 2000mm flexible drop hose with 4" TTMA flanged ends forms an important part of the overhead bottom loading arm. Generally supplied in flexible corrugated stainless steel for longevity they can also be supplied to code hose specification.

Standards

Corrugated Metal Hose: ISO 10380
 AGA Approved: AS 4631 (upon requirement)
 Welding Compliant: AS 4041- Class 1 (upon request)
 Seismic Rated: AS 1170 (upon request)
 Fire Protection Systems (upon request)



Specifications

Nominal Dia.		Outside Dia. (mm)			Weight (Kg/m)			Min. Bend Radius (mm)		Working Pressure (kPa)			Burst Pressure (kPa)		
mm	inch	SS0	SS1	SS2	SS0	SS1	SS2	Static	Dynamic	SS0	SS1	SS2	SS0	SS1	SS2
80	3"	97	100	103	1.62	3.12	4.62	350	800	294	2001	3202	294	8004	12808
100	4"	122	125	128	2.00	3.70	5.40	400	1000	294	1601	2501	294	6404	10004

Alternative products:

Refer to Fire Safe Code Hose - Page 187

Applications



9
8
7
6
5
4
3
2
1

STAINLESS STEEL HOSE

Stripwound Hose

Light Weight Engine Exhaust Interlock



Part No.: EEI4S

Construction: Unpacked

Profile: Medium Flexibility / Medium Pressure

Tube Available: 304 Stainless Steel

Size Available: 3/4" - 12"

(Larger sizes upon Request)

Max Temp: 700°C

Lengths: Min 3mtrs, supplied in 3mtr increments

Low | Med | High

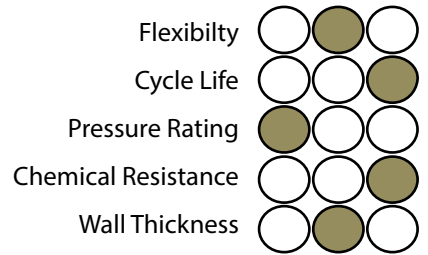

Construction

Typical applications include commercial vehicle, passenger vehicle plus plant and portable generator set exhaust systems. This is a general purpose flexible metallic light weight conduit designed for a variety of installations requiring motion, vibration and bending.



Part Number	Size	I.D. (mm)	O.D. (mm)	Bend Radius (mm)
EEI4S-20	3/4"	19	22.0	140
EEI4S-25	1"	25	28.0	152
EEI4S-32	1 1/4"	32	36.0	160
EEI4S-38	1 1/2"	38	41.3	166
EEI4S-41	1 5/8"	41	44.3	180
EEI4S-45	1 3/4"	44	47.3	190
EEI4S-48	1 7/8"	48	51.3	195
EEI4S-50	2"	51	54.3	205
EEI4S-54	2 1/4"	57	60.3	235
EEI4S-63	2 1/2"	63	66.3	260
EEI4S-70	2 3/4"	70	73.3	285
EEI4S-80	3"	76	79.3	205
EEI4S-90	3 1/2"	90	94.2	250
EEI4S-100	4"	102	106.2	370
EEI4S-114	4 1/2"	114	118.2	490
EEI4S-125	5"	127	131.2	515
EEI4S-140	5 1/2"	140	144.2	600
EEI4S-150	6"	152	156.2	655
EEI4S-175	7"	178	183.0	740
EEI4S-200	8"	203	208.0	800
EEI4S-225	9"	230	234.0	950
EEI4S-250	10"	254	259.0	1100
EEI4S-300	12"	305	310.0	1400

Applications



Stripwound Hose

Material Handling Lined Interlock



Part No.: MHI4S

Construction: Unpacked / Liner

Profile: Medium Flexibility / Medium Pressure

Tube Available: 304 Stainless Steel

Size Available: 1 1/4' - 10"

(Larger sizes upon Request)

Max Temp: 700°C

Lengths: Min 3mtrs, supplied in 3mtr increments

Low | Med | High

Flexibility

Cycle Life

Pressure Rating

Chemical Resistance

Wall Thickness

Construction

The interlock is specially wound into a double interlock hose from two separate metal strips. The double interlock hose is manufactured for the purpose of producing a liner to create a moderately smooth inner bore. The inner will provide a higher flow rate giving the hose a variety of advantages such as nil air loss from its tighter construction, elimination of materials degradation and contamination experienced with other hoses, as well as a longer service life due to greater abrasion resistance.



Applications may include large volume transfer of dry bulk materials, difficult to fluidize materials in industrial plants, ships, barges, silos, elevators, trucks and rail units. Uses include pneumatic transfer of bulk materials in powder, pellet, granules, flake or pebble form such as chemicals, feed, flour, grain, plastics, sugar, cement, pebble and lime.

Part Number	Size	I.D. (mm)	O.D. (mm)	Bend Radius (mm)
MHI4S-32	1 1/4"	32	36	203
MHI4S-40	1 1/2"	38	42	255
MHI4S-50	2"	51	55	355
MHI4S-54	2 1/4"	57	61	368
MHI4S-63	2 1/2"	63	67	381
MHI4S-80	3"	76	81	406
MHI4S-90	3 1/2"	95	100	432
MHI4S-100	4"	102	107	457
MHI4S-125	5"	127	132	559
MHI4S-150	6"	152	158	635
MHI4S-200	8"	200	210	900
MHI4S-250	10"	250	261	1200

Applications



9
8
7
6
5
4
3
2
1

STAINLESS STEEL HOSE

Vacuum Jacketed Hoses

These maintenance-free and durable cryogenic transfer lines are designed for use with cryogenic liquids and gases. Even with the extremely low temperatures below -150°C flowing through the hose, the outer surface remains at room temperature, ensuring safety when touched with bare hands. The reduced liquid and gas consumption of these hoses translates to cost savings for your business.

Vitalflex Vacuum Jacketed (VJ) hoses incorporate cutting-edge super insulation technology, guaranteeing optimal thermal efficiency. VJ products come in two options for vacuum insulation: static and dynamic vacuum types.

Thanks to the coaxial bellow construction, these hoses offer exceptional flexibility, allowing for easy manoeuvrability. Additionally, the use of lightweight stainless steel materials minimizes cool-down loss to an absolute minimum. To further protect the vacuum jacketed hoses, they are encased in a stainless steel spiral wrap or a braided outer cover, ensuring durability and longevity.

On top of that, (VJ) conditioning equipment comes with advanced close tolerance bayonet connections that guarantee frost and condensation-free operation, with the lowest heat leaks, preserving your cryogenic fluid at the lowest temperature and ensuring pressure stability. Vacuum Jacketed Transfer hoses are the epitome of thermal efficiency in transfer hoses, designed specifically to minimize and reduce loss of containment during operation.

Our lightweight inner tubing significantly reduces cooldown losses, enabling rapid hose cooldown and accelerating the delivery of cryogenic liquid to the desired point of use.

By utilizing our Vacuum Jacketed Transfer Hose, you can expect higher quality liquid with lower gas content at the point of use, thereby enhancing equipment efficiency.

- Ranging from semi-flexible to ultra-flexible to suit your type of application
- Hazardous ice & dripping water is reduced or eliminated, increasing safety.
- Outer surface is safe to the touch, even when used with liquid hydrogen or liquid helium.
- Interlocking stainless steel cover provides a light weight, durable, and flexible product.
- Each transfer hose is flow and leak tested to ensure superior quality.
- Standard lengths and end fittings are maintained in-stock for quick delivery.
- Custom configurations are also available.

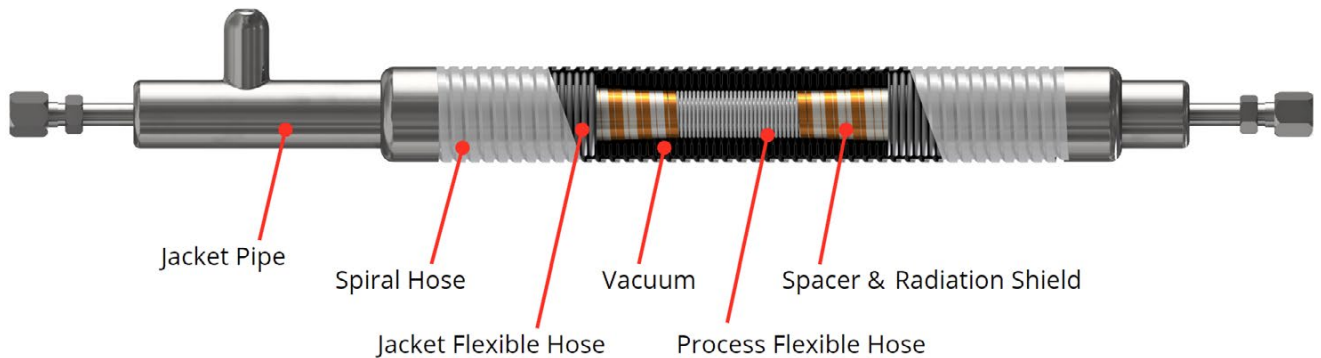

Options & Accessories

- Integrated vacuum jacketed tees and elbows
- Bayonet connections
- Vacuum jacketed shut-off valves
- Pressure relief valve assemblies
- Sintered metal diffusers (phase separators)
- High pressure ratings available upon request

Applications

- Electronic and Semiconductor
- Medical and Pharmaceutical
- Laboratory and Biotechnology
- Food and Beverage
- Aerospace
- Industrial

Mediums

- Hydrogen
- Helium
- Nitrogen
- Argon
- Oxygen
- Methane
- Propane

Vitalflex Vacuum Jacketed (VJ) VJ-Flex Hose Application Benefits

Reusability

Pre-engineered modular concept allows the vacuum insulated transfer hose to be easily reuse if use-point locations and plant layout is changed

Cost Saving

This option provides simplicity and cost saving as it reduces the necessity for precise system layout measurements

Time Saving

Readily available on the shelf for fast delivery, thus reduces material lead time for your cryogenic piping project

Vacuum Jacketed Hoses

Vitalflex Vacuum Jacketed (VVJ) provide transfer hoses with various flexibility to suit different piping needs and applications. All hoses comes with static vacuum as standard and dynamic vacuum as option. Static vacuum hose is vacuum sealed at the factory, providing many years of trouble free vacuum insulation. All hoses comes with high quality wear resistant stainless steel outer braid or kink resistant spiral wrap protection cover.

Vacuum Jacketed Semi (VVJS)

Pre-engineered modular vacuum insulated Vitalflex Vacuum Jacketed (VVJ) hose has added advantage over the traditional hoses, especially when piping system reconfiguration is frequently done. Vacuum jacketed hose can be added if required to the existing system without major rework expenses.



Vacuum Jacketed Cryo (VVJC)

Flexible transfer hose mainly used to overcome misalignment in rigid piping system; and as a final tie-in from rigid piping to equipment such as bulk tank & process equipment.



VITALFLEX® - Vacuum Jacketed Ultra (VVJU)

Offers high flexibility, sturdy & kink-resistant spiral wrap outer jacket, suitable for rough handling usage such as cryogenic liquid cylinder (LGC / dewar) refilling; and liquid withdrawal from pressurized dewar to test handler.

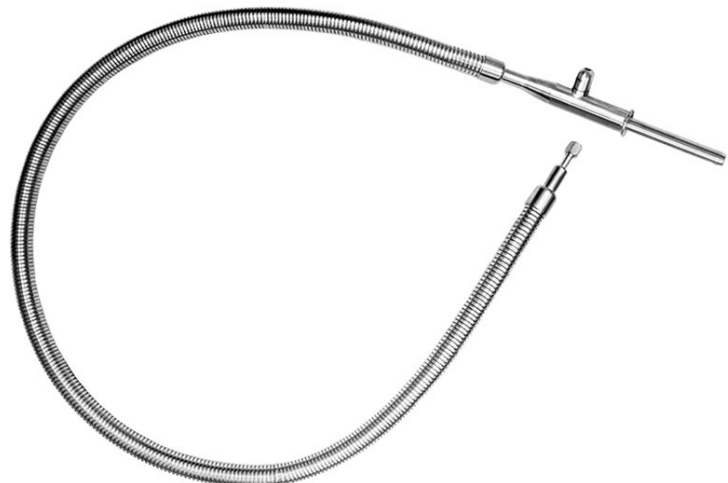

Stainless Steel Hose

VITALFLEX® - Vacuum Jacketed Semi (VVJS)

Construction: SS1-A Tube and Single Braid / SS2-A Tube and Double Braid
Profile: Annular / Close Pitch
Tube Available: 300 / 304 / 316 Stainless Steel /
Cover options: 300 / 304 / 316 Stainless Steel /
Size Available: 5/8" - 2"
(Larger sizes upon Request)
Max Temp: -196°C to 700°C

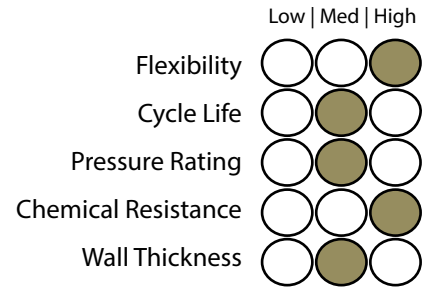

Construction

Vacuum Jacketed Semi (VVJS) is a semi-rigid bendable pipe with optimal flexibility is suitable for long distance piping system application, an alternative to traditional rigid piping. It's lightweight stainless steel construction reduces cool-down losses to an absolute minimum.

The VVJS hoses are protected by a high quality and wear resistant stainless steel braided outer covering. Typical hoses are manufactured with pipe thread ends or bayonet connection.

These hoses are used in a wide variety of applications as main transfer hose for LN2 such as food freezing, semiconductor test handlers, MBE and LN2 dosing applications.



Specifications

Part Number	Inner Dia (mm)	Outer Dia (mm)	"Steady State Heat Leak (watts/hr)"	"Bayonet heat leak (watts)"	Bend Radius (mm)	Working Pressure (kPa)
VVJS-16	16.2	52.1	1.3	1.2	300	1380
VVJS-25	25.1	62.8	1.4	2.4	400	1380
VVJS-32	34.2	81.2	1.5	2.4	450	1380
VVSJ-40	40	120	1.7	2.7	600	1380
VVSJ-50	50.1	120	1.6	3.3	720	1380

Optional manufacturing options: Pneumatic pressure test, Vacuum retention testing, LN2 cold shock, pre-material certs., X-ray, ASME B31.3 certification, CFOS cleaning for O2 services

End couplings available: Bayonet, threaded, flanged

1
2
3
4
5
6
7
8
9

STAINLESS STEEL HOSE

Stainless Steel Hose

VITALFLEX® - Vacuum Jacketed Cryo (VVJC)

Construction: SS1-A Tube and Single Braid / SS2-A Tube and Double Braid
Profile: Annular / Close Pitch
Tube Available: 300 / 304 / 316 Stainless Steel /
Cover options: 300 / 304 / 316 Stainless Steel /
Size Available: 5/8" - 2"
(Larger sizes upon Request)
Max Temp: -196°C to 700°C

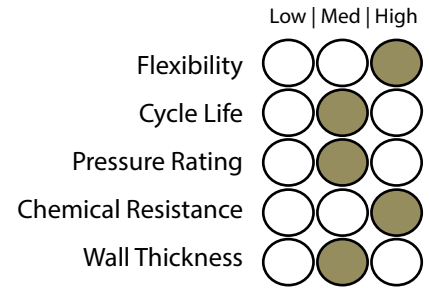

Construction

Vacuum Jacketed Cryo (VVJC) hoses are a vacuum insulated stainless steel flexible hose designed to meet high flow capacity without compromising its flexibility. Engineered as modular section with close tolerance bayonet connections. It can be used on its own, or as part of StatiRigid sections for misalignment offset. VVJC pipe is evacuated and sealed at the factory as a static vacuum and is available in dynamic vacuum. VVJC are available in wide variety of sizes from DN16 up to DN50 to meet most the standard or custom requirements.



Vitalflex Vacuum Jacketed (VVJC) offers a complete line of components such as inline venting devices, phase separators and gas traps to maximize the system performance. VVJC is used in a wide variety of applications including biotech, cryogenic storage, food and beverage, nanotech, environmental temperature chambers and R&D applications.

Specifications

Part Number	Inner Dia (mm)	Outer Dia (mm)	"Steady State Heat Leak (watts/hr)"	"Bayonet heat leak (watts)"	Bend Radius (mm)	Working Pressure (kPa)
VVJC-16	16.2	52.1	1.3	1.2	200	1380
VVJC-25	25.1	62.8	1.4	2.4	300	1380
VVJC-32	34.2	81.2	1.5	2.4	450	1380
VVJC-40	40	120	1.7	2.7	600	1380
VVJC-50	50.1	120	1.6	3.3	720	1380

Optional: Pneumatic pressure test, Vacuum retention testing, LN2 cold shock, pre-material certs., X-ray, ASME B31.3 certification, CFOS cleaning for O2 services

End couplings available: Bayonet, threaded, flanged

9
8
7
6
5
4
3
2
1

STAINLESS STEEL HOSE

Stainless Steel Hose

VITALFLEX® - Vacuum Jacketed Ultra (VVJU)

Construction: SS1-A Tube and Single Braid / SS2-A Tube and Double Braid
Profile: Annular / Close Pitch
Tube Available: 300 / 304 / 316 Stainless Steel /
Cover options: 300 / 304 / 316 Stainless Steel /
Size Available: 5/8" - 2"
(Larger sizes upon Request)
Max Temp: -196°C to 700°C

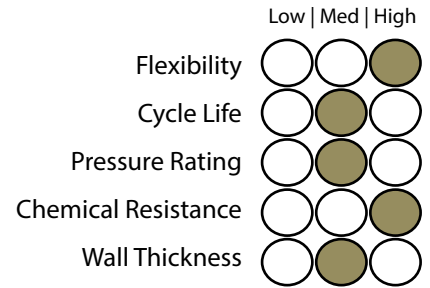

Construction

Ultra-Flex transfer hose is a ultra-flexible, vacuum insulated LN2 transfer hose with high flexibility. It has the lowest dynamic bend radius among all cryogenic hoses in the market. Due to its lightweight stainless steel construction, cool-down loss can be reduced to an absolute minimum.



Ultra-Flex hoses are protected by a tough and antikink stainless steel spiral wrap outer covering, its non wire braid prevent potential operator injury due to sharp wire found in traditional braided sleeve. Typical hoses are manufactured with pipe thread ends or female flare 1/2" JIC/CGA fittings or C5 bayonet.

These hoses are used in a wide variety of applications including tool connections with portable dewars supplying LN2 to test handlers, LN2 doser, or any moving reservoirs and custom OEM applications.

Specifications

Part Number	Inner Dia (mm)	Outer Dia (mm)	"Steady State Heat Leak (watts/hr)"	"Bayonet heat leak (watts)"	Bend Radius Static (mm)	Bend Radius Dynamic (mm)	Working Pressure (kPa)
VVJU-08	8.2	39	2.6	1.2	152	203	1030
VVJU-12	12.1	49	3	1.2	203	254	1030

Optional: Pneumatic pressure test, Vacuum retention testing, LN2 cold shock, pre-material certs., X-ray, ASME B31.3 certification, CFOS cleaning for O2 services

End couplings available: Bayonet, threaded, flanged

1
2
3
4
5
6
7
8
9

STAINLESS STEEL HOSE

Stainless Steel Hose

Vacuum Jacketed Pipes (VJP)

Construction: Coaxial stainless steel pipe
Profile: Combination smooth inner pipe with convoluted bellow
Tube Available: 304 / 316 Stainless Steel
Cover options: Radiation Shield
Size Available: 3/4" - 3"
(Larger sizes upon Request)

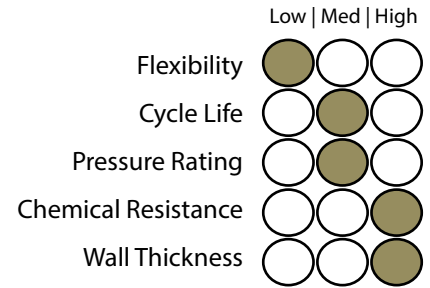

Construction

Engineered as modular sections, these stainless steel coaxial vacuum insulated piping spools are joined together with close tolerance bayonet connections, forming a complete cryogenic transfer system. Each section is evacuated, sealed and tested for vacuum integrity to ensure minimal heat gain.



Vacuum Jacketed Pipes (VJP) come with internal bellows at required intervals to serve as thermal expansion compensators according to EJMA calculation. The pipe comes with smooth inner bore to minimize pressure drop and improve flow characteristics. Installation for VJP can be done easily both indoor and outdoor, by incorporating flexible sections strategically to offset misalignments. VJP offers a complete line of components including in-line venting devices, phase separators and gas traps to maximize the cryogenic system performance.

Specifications

Part Number	Inner pipe Dia (mm)	Outer Jacket Pipe Dia (mm)	Actual internal flow Dia (mm)	Hole Required to Accommodate Pump Out (mm)	Bayonet Clamp OD (mm)
VJP-5T	19.05	60.3	16.6	100	51
VJP-5P	21.3	60.3	18	100	65
VJP-10T	29	73	26.6	120	65
VJP-10P	33.4	88.9	30	120	78
VJP-15P	48.3	101.6	45	150	91
VJP-20P	60.3	101.6	57	180	120
VJP-30P	88.9	141.3	85	200	145

9
8
7
6
5
4
3
2
1

STAINLESS STEEL HOSE

Stainless Steel Hose and Fittings

Hose Part Numbers:

SSABC-D-E

A:	Braid quality required	0 = no braid	1 = Single Braid	2 = Double Braid	3 = Triple Braid
B:	Tube Material	6S = 316 Tube	4S = 304 Tube		
C:	Braid Material	6S = 316 Braid	4S = 304 Braid		
D:	Hose Type	A = Annular, B = Braided Braid, O = Omega			
E:	Hose Size	06 = 1/4", 10 = 3/8", 12 = 1/2", 20 = 3/4", 25 = 1", 32 = 1-1/4", 40 = 1-1/2"			

Example: SS16S4S-A-40 = 1-1/2" Single Braided Annular Stainless Steel Hose, 316 Tube and 304 Braid

Example: SS26S6S-A-50 = 2" Double Braided Annular Stainless Steel Hose, 316 Tube and 316 Braid

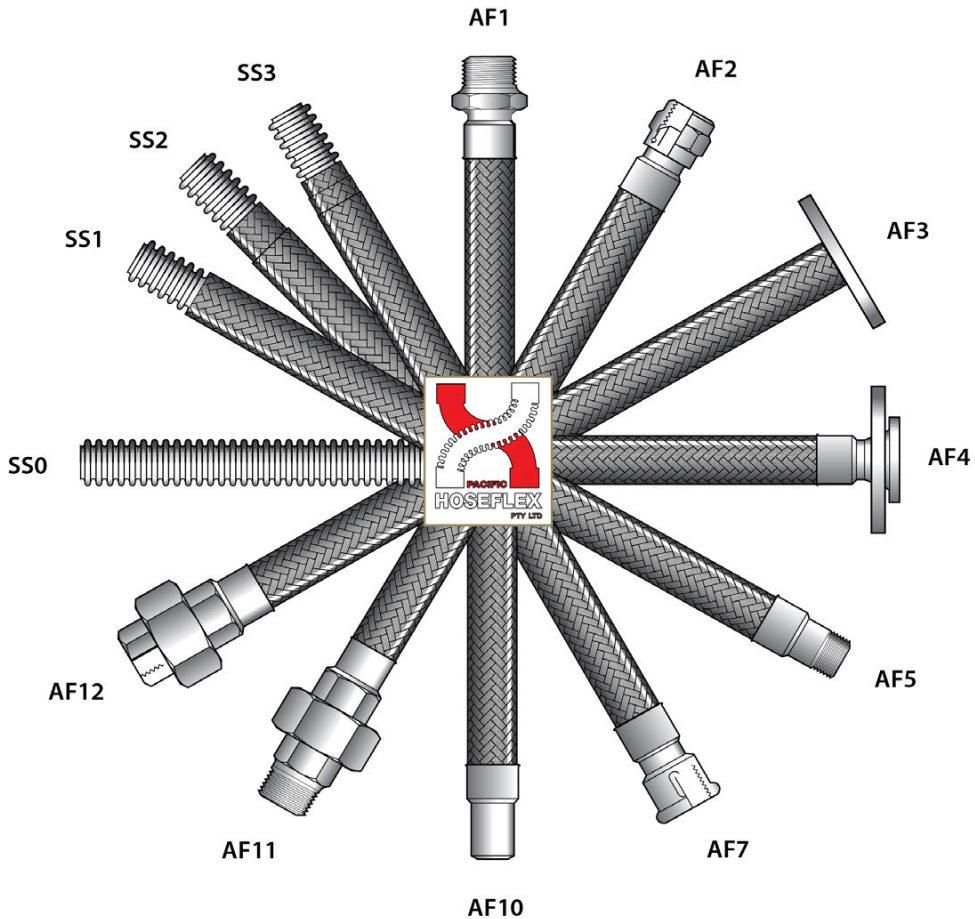

Fitting Part Numbers:

AF1 - Fixed Hex Male	AF7 - Fixed Female Socket	SS0 - Convoluted hose
AF2 - Swivel Female	AF10 - Welded Pipe End	SS1 - Convoluted hose + Single Braid
AF3 - Fixed Flange	AF11 - Male Union	SS2 - Convoluted hose + Double Braid
AF4 - Swivel Flange	AF12 - Female Union	SS3 - Convoluted hose + Triple Braid
AF5 - Toe Nipple		

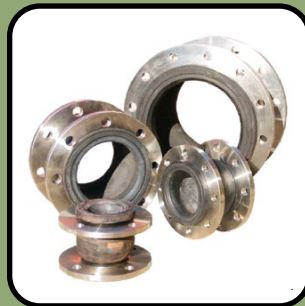

03



EXPANSION JOINTS

The Range

METALLIC EXPANSION JOINTS

Size : 2" to 60" (Larger sizes upon Request)

SEJ	SINGLE	Page 71
DAEJ	DOUBLE AXIAL	Page 72
UEJ	UNIVERSAL	Page 73
DMEJ	DIESEL MULTI-PLY	Page 74
DEJ	DIESEL	Page 75
DDEJ	DOUBLE DIESEL	Page 76
HEJ	SINGLE HINGE	Page 77
DHEJ	DOUBLE HINGE	Page 78
GEJ	SINGLE GIMBLE	Page 79
DGEJ	DOUBLE GIMBLE	Page 80
TEJ	SINGLE TIED	Page 81
DTEJ	DOUBLE TIED	Page 82
V-SHAPE	SEISMIC JOINT V-SHAPE	Page 87
U-SHAPE	SEISMIC JOINT U-SHAPE	Page 91
XT	EXTERNALLY PRESSURISED	Page 95
DXT	DOUBLE EXTERNALLY PRESSURISED	Page 97

Page 71



SEISMIC JOINTS

Size : 1" to 6" (Larger sizes upon Request)

Page 84



PTFE EXPANSION JOINTS

Size : 1" to 12" (Larger sizes upon Request)

Page 99



RUBBER EXPANSION JOINTS

Size : 1 1/4" to 24" (Larger sizes upon Request)

Page 105



FABRIC EXPANSION JOINT

Size : 4" to 80" (Larger sizes upon Request)

Page 113



Metallic Expansion Joints Design

Introduction

Expansion joints are employed in piping systems to absorb different thermal expansion while containing the system pressure. They are successfully utilised in refineries, chemical plants, fossil and nuclear systems, heating and cooling systems, and cryogenic plants.

Any pipe connecting two points is subject to numerous types of action which result in stresses on the pipe.

Some of the causes of these stresses are:

- Internal or external pressure at working temperature
- Weight of the pipe itself and the parts supported
- Movement imposed on the pipe sections by external restraints
- Thermal expansion

The stress on the wall of piping is related to the force or movement exerted on it by external resistance and the flexibility of the pipe itself.

When either the value of the stresses or the value of the external forces or movements exceeds the maximum allowable value(s), the flexibility of the pipe must be increased artificially. This can be done either by altering the layout of the pipe or by inserting high flexibility sections.

This is precisely the function of expansion joints.

Depending on the type of movement to be absorbed, expansion joints can be classified as follows:

- Axial
- Universal
- Angular (hinged)
- Spherical angular (gimbal)
- Lateral
- Spherical lateral
- Pressure balance axial
- Pressure balance universal



Design and Manufacture

Pacific Hoseflex has a variety of different size expansion joints available from 50 mm to 5000 mm in diameter, with working pressures up to 10,000 kPa. Consideration must be taken into account when elevated temperatures are involved. They reduce both rated movement for a given life cycle and pressure capabilities of the expansion joint.

Bellows operate best at normal pressure ratings temperatures between 70° C to 80° C. The austenitic range of stainless steel is susceptible to high stresses in the presence of corrosive agents, such as chlorides, caustic alkalis, hydrogen sulfide and nitrates.

Definition of Movement

Axial Movement

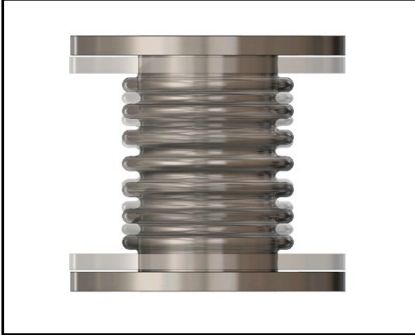

Axial Compression is the dimensional shortening of an Expansion Joint along its longitudinal axis while axial extension is the dimensional lengthening of the expansion joint.

Lateral Movement

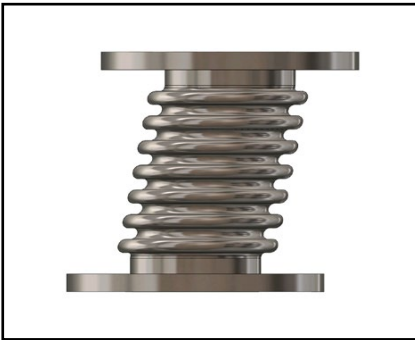

Lateral Deflection is the relative displacement of the two ends of an Expansion Joint perpendicular to its longitudinal axis.

Angular Movement

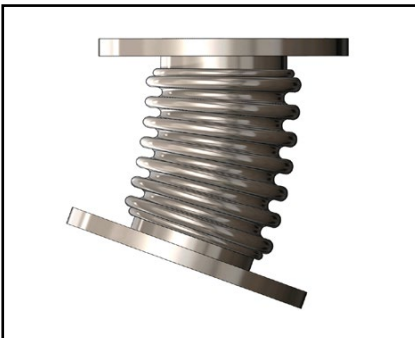

Angular Rotation is the displacement of the longitudinal axis of the Expansion Joint from its initial straight line position into a circular arc.

Cycle Life & Quality Management

Cycle Life

This is the anticipated number of complete expansions and contractions that a bellow can accommodate in its working life. This is an important consideration with bellow design. This consideration is to ensure the correct balance between the pressure containing characteristics and the movement.

The cycle life expectancy of an expansion joint is affected by the following various factors:

- operating pressure
- operating temperature
- the material from which the bellows is made
- the movement per convolution
- the thickness of the bellow
- the convolution pitch
- depth and shape of convolution

After installation, any change to any of these factors will impact upon the cycle life.



Asset (Hose) Management System

Pacific Hoseflex has developed and implemented a Asset (Hose) Management System to offer clients complete traceability. Our system is flexible and can be customized to accommodate the specific needs of individual clients

With accredited Quality Assurance:

- ISO 9001 Quality
- ISO 14001 Environmental
- ISO 45001 Safety

Pacific Hoseflex quality control measures, inspection and testing procedures include; inwards goods inspection, in-process inspection, final product release inspection and leak detection inspection. There are several different methods for leak detection: dye penetrate examination, X-ray examinations, magnetic particle inspection, hydrostatic test and pneumatic test.



Bellow Forming & Material

Bellows forming

The basic method(s) of bellows manufacture is not complicated. There are two ways that a bellows can be manufactured:

1. Mechanical forming can be done by either rolling the convolutions between external and internal wheels.
2. Hydraulic forming, using internal pressure has a much greater life than bellows formed by the other method(s). Bellows shall be hydraulically formed from a tube having only longitudinal seams. When the ratio of corrugation diameter to shell diameter is large, as in small diameter bellows, the units shall be annealed to remove stresses created by the forming operation.

The number of convolutions depends upon the amount of movement the bellows must accommodate or the force that must be used to accomplish the deflection. Since bellows are unique, there are many design considerations which must be evaluated. The convoluted element must be strong enough circumferentially to withstand the line pressure of the system, yet responsive enough longitudinally to flex. The longitudinal load (pressure thrust) must then be absorbed by some other type of device. These are usually anchors, tie rods, hinges or gimbal structures.

Under pressure a bellows will crave to squirm. This can occur when a bellow is subjected to a pressure greater than 1.5 times the design pressure. Squirm can be considered the same as column buckling in a beam under compressive loading. The convolutions deform and even though there is no leaking, both cycle life and pressure capacity is greatly reduced.

Bellows Material

Stainless Steel 304

Is a lower grade material than 321 SS with less resistance to corrosion. Applications include diesel engine exhaust manifolds and steam.

Stainless Steel 321

The most common material used for bellow manufacture. It combines excellent mechanical properties with adequate corrosion resistance. Applications include diesel engine exhaust manifolds and steam.

Stainless Steel 316

Has a better corrosion resistance than 321 SS and can be used as an alternative to Incoloy 825. Applications include engine exhaust manifolds, steam and marine services.

Incoloy 825, 800

A high nickel alloy specifically designed for use in aggressive environment. It is very resistant to pitting and crevice corrosion and virtually immune to stress corrosion cracking. It can be used up to a maximum temperature of 425° C. Applications include diesel engine exhaust manifolds, steam, crude oil lines and flue gases.

Inconel 625, 600 and 800

Is a high nickel alloy with good corrosion resistant and temperature capability higher than 425° C.

Nickel 200, 253 MA

This alloy has good mechanical properties and excellent corrosion resistance to alkalis, i.e. sodium hydroxide. It also has good electrical, thermal and magneto-strictive properties. Applications include food and synthetic fibre processing, heat exchangers, chemical and electrical industries.

Hastelloy

It has a high-strength, nickel based, corrosion resistant alloy. Other components include molybdenum and chromium. It is well suited for most chemical applications. It has excellent resistance to pitting, stress-corrosion and cracking

254 SMO

This is a very high end austenitic stainless steel that combines impact toughness resistance to chloride stress corrosion cracking, pitting and crevice corrosion with strength nearly twice that of 300 series stainless steels. In some applications it has been found to be a more cost effective substitute for high nickel and titanium alloys.



Liners

Single Liners

Liners are used to prevent flow induced vibration or erosion caused by abrasive materials. When lateral movement is required in the expansion joint, the flow liner diameter must be reduced to provide clearance.

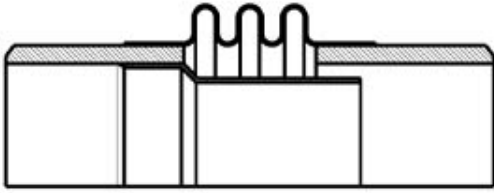

Single Welded Liner

Most common type of internal liner.
Maximum durability.

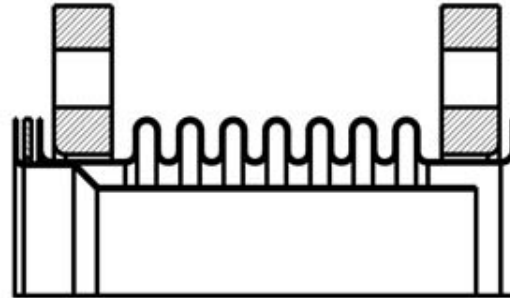

Single Drop-In Liner

Can be removed and cleaned.

Telescopic Liners

Telescoping liners are used on short expansion joints with large axial movements. When fit close together, they can also be used in systems where the flow can be in either direction.

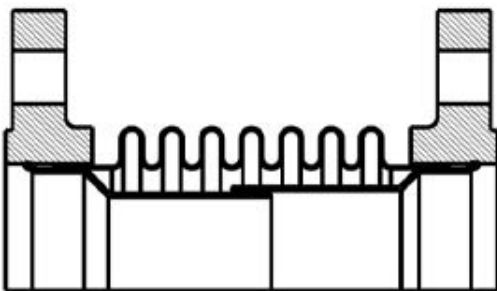

Telescoping Welded Liner

For large axial movements.

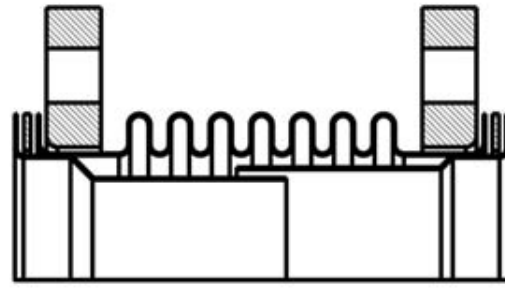

Telescoping Drop-In Liner

For large axial movements. Can be removed and cleaned.

Rods Restraints

Restraints

Restraints are used for lateral and angular compensators. The restraints absorb axial reaction force produced by inner pressure. Even so, the connected pipe must be equipped with light fixed points to absorb moving force and moments. Precise rating details and operating parameters of the corresponding machinery or equipment must be known to correctly calculate the degree of restraints.

Rubber Expansion Joint Rod Restraints

There are two types of tie rods restraints for lateral rubber compensators:

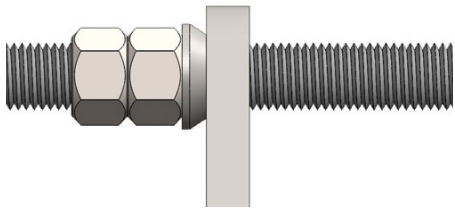

Outer restraints are used to absorb reaction force from internal pressure

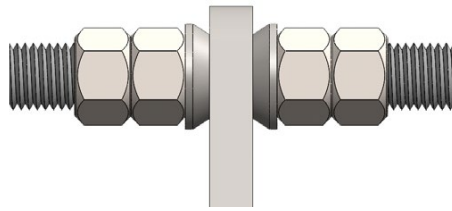

Outer and inner restraints are used to absorb reaction force from internal pressure and vacuum



Metallic Expansion Joint Rod Restraints

Lateral compensators are equipped with adapters for tie rods restraints. The design differs between flanges with welded ears or oval flanges depending on compensator type and size. Tie rods restraints run conical seats.

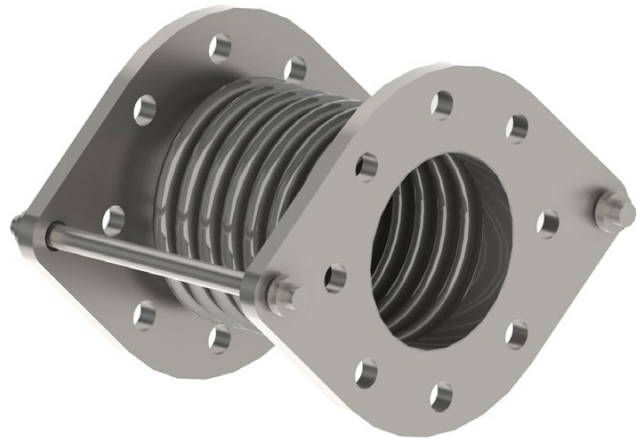
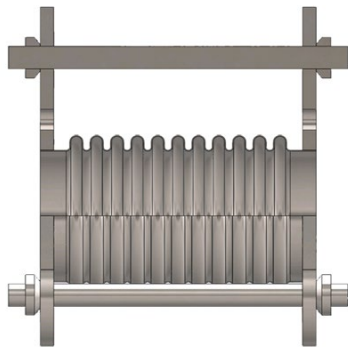

Pipe Supports & Hangers

Insulated Pipe Clamps

Made from thicker material and can withstand greater loads and movement/strong vibrations making it a safe and reliable solution for supporting emergency high pressure fire sprinkler system pipework. The weld nut on all sizes is designed for M12 threaded rod. Zinc Plated to AS1789:2003 to meet grade Fe/Zn12 as a standard material finish.



Clevis Hanger

Recommended for the suspension of stationary non-insulated pipe lines. Also commonly used for the suspension of insulated pipe lines, Flared edges help prevent sharp surfaces from coming into contact with the pipe. Clevis bottom pivots to allow pipe to be fed from either direction.



U Bolt Support

Heavy duty insulated U bolt that is supplied with a 10mm thick cork and neoprene base. It is designed to provide support for large heavy weight pipes made out of stainless steel, duplex/super duplex or other materials.



Clamped Pipe Support

Clamped Pipe Shoe supports pipe nominal bores from 25NB through to 1150NB are manufactured from material to meet AS/NZS1594:2002 and either Hot Dip Galvanised to AS4680:2006 or available in Stainless Steel.



Saddle Pipe Support

Saddle Clamps to suit Steel Pipe for general plumbing are manufactured from material to meet AS/NZS1594:2002, and Hot Dip Galvanised to meet AS/NZS4680:2006 or available in Stainless Steel.



Chain

Strong and durable, use this heat-treated chain when using fittings with chain. You must match the chain size and meet or exceed the chain's grade.



Channel and Struts

Can be supplied in lengths of 41mm wide channel/strut with a choice of thicknesses, heights and materials. Channel provides an ideal mechanical support frame for a range of applications, and is a great starting point for installing electrical cable or pipe management systems. It can be provided in plain style, slotted with evenly spaced slots along its length, or in a range of different welded combinations. Other variants allow for easy installation/securing of the product into concrete.



Metallic Expansion Joints Installation Guide

Storage:

1. Store expansion joints in a dry/cool location such as a warehouse.
2. Store flange face down on a pallet or wooden platform.
3. Do not store other heavy items on top of expansion joint (s).
4. Ten-year shelf life can be expected with ideal conditions.

Handling:

Do not lift with ropes or bars through the bolt holes. If lifting through the bore, use padding or a saddle to distribute the weight. Do not let expansion joints sit vertically on the edges of the flanges for any period of time. Do not lift on the shipping restraints.

Service Conditions:

Make sure the expansion joint rating for temperature, pressure, movements, and selection of materials match the system requirements. Contact the manufacturer if the system requirements exceed those of the expansion joint selected.

Alignment:

Expansion joints are not designed to make up for piping misalignment errors. Check with the manufacturer if piping misalignment is present.

Anchoring:

The main function of expansion joints is to compensate for axial pipe thermal expansion. Metal expansion joints must have the protection of adequate anchoring against the internal and thrust pressures of the media to prevent damage. Anchoring must be installed as close to the down stream end of the expansion joint as possible, with the originating equipment serving as the opposite anchor. Anchors must prevent pipe movement in any direction. Hangers or pipe pedestals cannot be considered to be anchors as they offer no restriction against side or end motion.

When designing an anchor for a metal expansion joint, consult the internal thrust force table from the appropriate expansion joint catalogue. The weight of piping, valves, and media, as well as the resistance of the piping to deflection, must be included as part of the design weight and strength of an anchor.

Anchors are required whenever a piping system changes direction. Expansion joints should be located as close as possible to anchor points. For additional expansion joint protection, it is recommended that control rods be installed on the expansion joint to prevent excessive movements from occurring due to pressure thrust of the line.

Guides:

Expansion joints must be properly guided and anchored in accordance with EJMA standards. (Refer to Pipe Guides Spacing Diagram below)

Pipe Support:

Piping must be supported so expansion joints do not carry any pipe weight.

Pipe Guides - Spacing Diagram

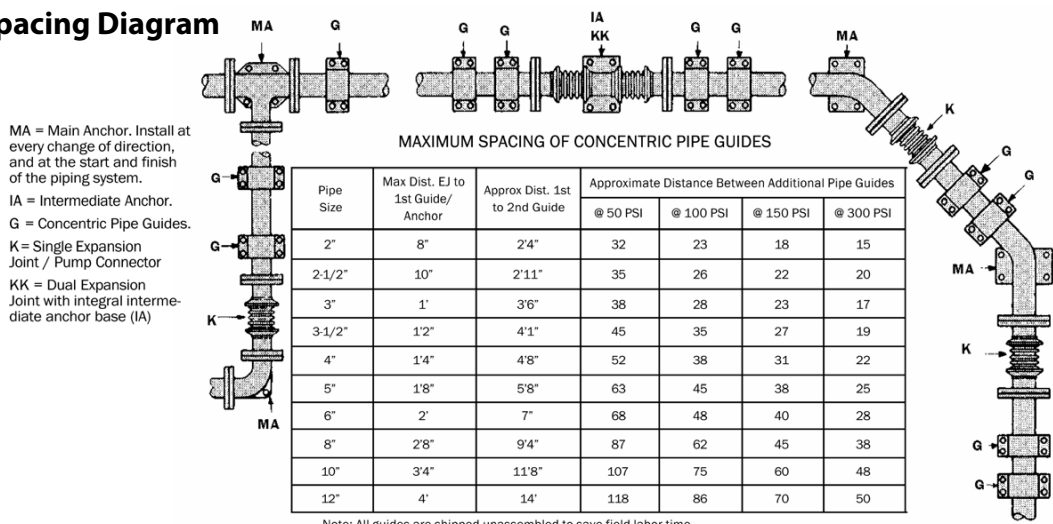



Metallic Expansion Joints Installation Guide

Mating Flanges:

Install the expansion joint flange against the mating pipe flanges and install bolts so that the bolt head is against the expansion joint flange. Bolts should be installed from the bellows side (so that the bolt heads are adjacent to the bellows) to insure that the bolts do not interfere with the bellows during periods of compression. Flange-to-flange dimensions of the expansion joint must match the required opening.

Make sure mating flanges are clean and are matched to the type supplied with the expansion joint. Gaskets of appropriate material, size and temperature ratings must be used in all flange-to-flange type installations.

Bolt Torque:

Tighten bolts in stages by alternating around the flange. Never tighten an expansion joint to the point that there is metal-to-metal contact between the expansion joint flange and the mating flange.

Shipping Restraints:

The expansion and compression movements are preset at the factory. The shipping restraints protect the expansion joint in its neutral position prior to installation. Remove the shipping restraints after installation and before hydro-testing the system.

Additional Tips:

1. Insulation or thermal blankets over a metal expansion joint should be supplied by the expansion joint manufacturer to preclude the use of corrosive chloride bearing insulation materials. Insulation should be installed to permit easy access to the flange area, to check bolting.
2. Do not weld in the near vicinity of a non-shrouded expansion joint without protecting the expansion joint from damaging weld splatter.
3. If an expansion joint is to be installed underground, or will be submerged in water, contact the manufacturer for specific guidelines.
4. Consider ordering a spare expansion joint. The cost of downtime of a critical expansion joint far exceeds the cost of a spare unit placed and protected in reserve on-site.
5. Whenever possible, install the expansion joint next to an anchor as indicated below not exceeding maximum distance to the 1st guide with at least two concentric pipe guides on the opposite side of the joint. Added guides are required to prevent bowing or bending of the pipe.
6. When an expansion joint is placed elsewhere in the line, at least two concentric guides must be used on each side of the joint with added joints installed as recommended in pipe guide spacing diagram.
7. The inside of all piping must be clean before installing and testing the expansion joints. Expansion joints should not be subjected to hydrostatic pressure tests beyond their rated working pressure.
8. Secure all anchors and guides before testing. Remove shipping bars prior to testing.
9. Expansion joints must be removed from the lines while the system is being tested hydrostatically at pressure exceeding allowable working pressure.
10. Expansion Joints fabricated with flow liners must be installed with the flow arrow pointing in the same direction of the media flow.
11. Single externally pressurized expansion joints must be installed with the moving end adjacent to the moving end of the pipe responding to the thermal expansion induced during system heat-up.
12. Failure to install according to instructions will void warranty.

Single Expansion Joint (SEJ)

Expansion Joint - SEJ

Part No.: SEJ

Construction: Convoluted

Material: 304, 321, 316, Incoloy, Inconel, Nickel, Hastelloy

Profile: Medium Flexibility / High Pressure

Liner: Optional

Size Available: 2" - 40"

(Larger sizes upon Request)

Temperature: -196°C +900°C

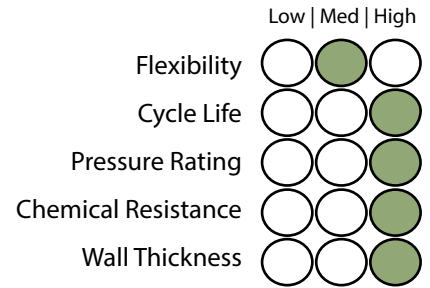

Construction

Use:

Used for absorbing axial, angular and small amounts of lateral movement. Pressure thrust will be transmitted onto the pipeline.



Specifications

Part Number	Nom	Length		Max. Working Pressure kPa	Movements			Spring Rate N/MM	Pressure Thrust KN
	Bore	Flanged	Weld Ends		Axial	Lateral	Angular		
	(mm)	(mm)	(mm)		(mm)	(mm)	(Deg)		
50 SEJ-240	50	145	218	240	32	12	18	21	1
50 SEJ-700	50	145	218	700	21	8	18	21	3
50 SEJ-1400	50	145	218	1400	18	7	18	70	6
65 SEJ-240	65	180	234	240	36	12	18	19	2
65 SEJ-700	65	180	234	700	28	11	18	57	4
65 SEJ-1400	65	180	234	1400	22	7	18	102	9
80 SEJ-240	80	180	278	240	34	13	18	12	2
80 SEJ-700	80	180	278	700	34	13	18	36	6
80 SEJ-1400	80	180	278	1400	25	8	17	130	12
100 SEJ-240	100	190	278	240	36	13	18	47	3
100 SEJ-700	100	190	278	700	32	10	18	84	9
100 SEJ-1400	100	190	278	1400	27	7	14	169	19
125 SEJ-240	125	215	313	240	50	13	18	50	4
125 SEJ-700	125	215	313	700	37	10	18	87	14
125 SEJ-1400	125	215	313	1400	27	7	14	169	27
150 SEJ-240	150	215	338	240	50	15	18	50	6
150 SEJ-700	150	215	338	700	39	9	18	72	19
150 SEJ-1400	150	215	338	1400	26	6	14	330	39
200 SEJ-240	200	225	330	240	57	16	18	28	11
200 SEJ-700	200	225	330	700	47	9	17	105	33
200 SEJ-1400	200	225	330	1400	30	6	13	541	66
250 SEJ-240	250	245	341	240	64	17	18	27	17
250 SEJ-700	250	245	341	700	62	10	18	120	51

Additional sizes available. Visit www.hoseflex.com for our complete range



EXPANSION JOINTS

Double Axial Expansion Joint (DAEJ)

Expansion Joint - DAEJ

Part No.: DAEJ

Construction: Convoluted

Material: 304, 321, 316, Incoloy, Inconel, Nickel, Hastelloy

Profile: Medium Flexibility / High Pressure

Liner: Standard Flow Liner

Size Available: 2" - 24"

(Larger sizes upon Request)

Temperature: -196°C +900°C

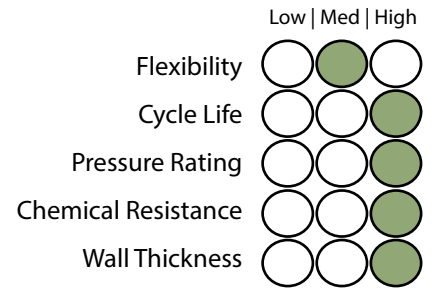

Construction

Use:

Used for absorbing large amounts of axial movement. Pressure thrust will be transmitted onto the pipeline. Correct anchoring and guiding must be used. Internal flow liner for eliminating velocity and flow problems is fitted as standard.



Specifications

Part Number	Nom	Length		Max. Working Pressure kPa	Axial Movement (mm)	Spring Rate N/MM	Pressure Thrust KN
	Bore	Flanged	Weld Ends				
	(mm)	(mm)	(mm)				
50 DAEJ-240	50	380	440	240	64	11	1
50 DAEJ-700	50	380	440	700	42	35	3
50 DAEJ-1400	50	380	440	1400	36	35	6
65 DAEJ-240	65	450	440	240	72	10	2
65 DAEJ-700	65	450	440	700	56	29	4
65 DAEJ-1400	65	450	440	1400	44	51	9
80 DAEJ-240	80	450	440	240	68	6	2
80 DAEJ-700	80	450	440	700	68	18	6
80 DAEJ-1400	80	450	440	1400	50	65	12
100 DAEJ-240	100	450	580	240	72	24	3
100 DAEJ-700	100	450	580	700	64	42	9
100 DAEJ-1400	100	450	580	1400	46	85	19
125 DAEJ-240	125	450	580	240	100	25	4
125 DAEJ-700	125	450	580	700	72	44	14
125 DAEJ-1400	125	450	580	1400	52	85	27
150 DAEJ-240	150	450	580	240	102	21	6
150 DAEJ-700	150	450	580	700	78	36	19
150 DAEJ-1400	150	450	580	1400	52	165	39
200 DAEJ-240	200	450	580	240	114	14	11
200 DAEJ-700	200	450	580	700	94	53	33
200 DAEJ-1400	200	450	580	1400	60	271	66
250 DAEJ-240	250	470	582	240	128	14	17
250 DAEJ-700	250	470	582	700	124	60	51

Additional sizes available. Visit www.hoseflex.com for our complete range

EXPANSION JOINTS



EXPANSION JOINTS

Universal Expansion Joint (UEJ)

Expansion Joint - UEJ

Part No.: UEJ
Construction: Convoluted
Material: 304, 321, 316, Incoloy, Inconel, Nickel, Hastelloy
Profile: Medium Flexibility / High Pressure
Liner: Optional
Size Available: 2" - 60"
(Larger sizes upon Request)
Temperature: -196°C +900°C

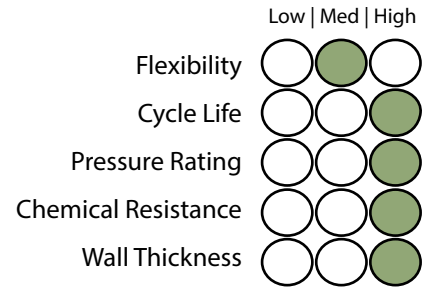

Construction

Use:
 Used for absorbing large amounts of axial, angular and lateral movement in low pressure pipelines. Pressure thrust will be transmitted onto the pipeline.



Specifications

Part Number	Nom	Length		Max. Working Pressure	Movements			Spring Rate	Pressure Thrust
	Bore	Flanged	Weld Ends		Axial	Lateral	Angular		
	(mm)	(mm)	(mm)		(mm)	(mm)	(Deg)		
50 UEJ-200	50	380	460	200	64	76	18	11	0.8
65 UEJ-200	65	380	460	200	64	76	18	10	1.4
80 UEJ-200	80	380	460	200	70	76	18	6	1.8
100 UEJ-200	100	430	526	200	72	76	18	24	2.8
125 UEJ-200	125	430	526	200	106	130	18	25	4.0
150 UEJ-200	150	430	576	200	106	120	18	21	5.6
200 UEJ-200	200	450	560	200	114	98	18	14	9.4
250 UEJ-200	250	485	582	200	112	98	18	14	14.8
300 UEJ-200	300	555	700	200	152	114	18	14	20
350 UEJ-200	350	540	736	200	178	114	18	30	24
400 UEJ-200	400	540	736	200	178	114	18	43	30
450 UEJ-200	450	540	772	200	182	102	18	49	38
500 UEJ-200	500	540	772	200	182	102	16	37	46
600 UEJ-200	600	540	772	200	148	86	16	45	66
650 UEJ-200	650	690	790	200	108	72	15	72	76
700 UEJ-100	700	690	790	100	111	72	15	82	43
750 UEJ-100	750	690	790	100	119	70	15	71	50
800 UEJ-100	800	690	790	100	122	64	15	74	58
850 UEJ-100	850	690	790	100	112	60	15	79	64
900 UEJ-100	900	690	790	100	112	59	15	87	71
950 UEJ-100	950	690	790	100	120	57	15	93	79
1000 UEJ-100	1000	1190	1290	100	120	54	14	121	85
1050 UEJ-100	1050	1190	1290	100	78	68	14	127	96

Additional sizes available. Visit www.hoseflex.com for our complete range



EXPANSION JOINTS

Diesel Multi-ply Expansion Joint (DMEJ)

Expansion Joint - DMEJ

Part No.: DMEJ

Construction: Convuluted

Material: 304, 321, 316, Incoloy, Inconel, Nickel, Hastelloy

Profile: Medium Flexibility / High Pressure

Liner: Standard Flow Liner

Size Available: 2" - 60"

(Larger sizes upon Request)

Temperature: -196°C +900°C

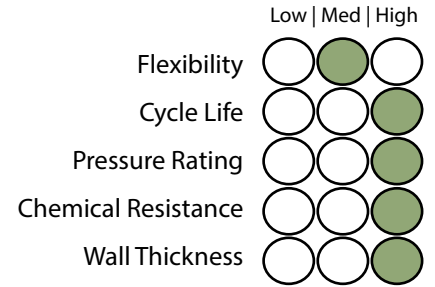

Construction

Use:

Used for vibration and absorbing thermal expansion in exhaust, gas ducting and low pressure systems. Relieves stresses caused by vibration. Specially designed multi ply element. Internal flow liners for eliminating velocity and flow problems fitted as standard.



Specifications

Part Number	Nom	Length		Max. Working Pressure	Movements			Spring Rate	Pressure Thrust
	Bore	Flanged	Weld Ends		Axial	Lateral	Angular		
	(mm)	(mm)	(mm)		(mm)	(mm)	(Deg)		
50 DMEJ-100	50	145	218	100	16	4	12	59	0.4
65 DMEJ-100	65	180	234	100	29	5	14	36	0.7
80 DMEJ-100	80	180	240	100	26	6	14	26	0.9
100 DMEJ-100	100	190	278	100	28	6	14	63	1.4
125 DMEJ-100	125	215	313	100	28	7	14	69	2.0
150 DMEJ-100	150	215	338	100	26	8	14	78	2.8
200 DMEJ-100	200	225	330	100	39	8	13	106	4.7
250 DMEJ-100	250	330	400	100	84	10	14	38	7.4
300 DMEJ-100	300	330	400	100	86	11	14	44	10
350 DMEJ-100	350	330	400	100	88	11	14	46	12
400 DMEJ-100	400	330	400	100	76	10	13	64	15
450 DMEJ-100	450	330	400	100	78	11	13	68	19
500 DMEJ-100	500	330	400	100	81	12	13	75	23
600 DMEJ-100	600	330	400	100	84	10	12	88	33
650 DMEJ-100	650	400	460	100	84	10	14	132	38
700 DMEJ-100	700	400	460	100	84	10	14	136	43
750 DMEJ-100	750	400	490	100	96	12	14	123	50
800 DMEJ-100	800	400	490	100	96	12	14	129	58
850 DMEJ-100	850	400	490	100	98	11	13	139	64
900 DMEJ-100	900	400	490	100	98	10	13	146	71
950 DMEJ-100	950	400	490	100	90	10	13	153	79
1000 DMEJ-100	1000	400	490	100	90	9	10	166	85
1050 DMEJ-100	1050	400	490	100	90	8	10	164	96

Additional sizes available. Visit www.hoseflex.com for our complete range

9
8
7
6
5
4
3
2
1

EXPANSION JOINTS



EXPANSION JOINTS

Diesel Expansion Joint (DEJ)

Expansion Joint - DEJ

Part No.: DEJ

Construction: Convoluted

Material: 304, 321, 316, Incoloy, Inconel, Nickel, Hastelloy

Profile: Medium Flexibility / Low Pressure

Liner: Standard Flow Liner

Size Available: 2" - 60"

(Larger sizes upon Request)

Temperature: -196°C +900°C

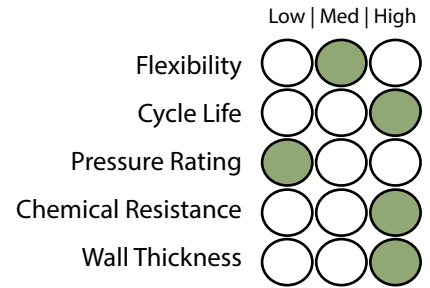

Construction

Use:

Used for absorbing thermal expansion in exhaust, gas ducting and low pressure systems. Pressure thrust will be transmitted onto pipeline. Internal flow liners for eliminating velocity and flow problems fitted as standard.



Specifications

Part Number	Nom	Length		Max. Working Pressure kPa	Movements			Spring Rate N/MM	Pressure Thrust KN
	Bore	Flanged	Weld Ends		Axial	Lateral	Angular		
	(mm)	(mm)	(mm)		(mm)	(mm)	(Deg)		
50 DEJ-100	50	145	218	100	36	12	18	21	0.4
65 DEJ-100	65	180	234	100	39	12	18	19	0.7
80 DEJ-100	80	180	240	100	44	13	18	12	0.9
100 DEJ-100	100	190	278	100	44	13	18	47	1.4
125 DEJ-100	125	215	313	100	50	13	18	50	2.0
150 DEJ-100	150	215	338	100	54	15	18	42	2.8
200 DEJ-100	200	225	330	100	59	16	18	28	4.7
250 DEJ-100	250	245	341	100	70	17	18	27	7.4
300 DEJ-100	300	280	400	100	82	18	18	28	10
350 DEJ-100	350	270	418	100	89	15	18	59	12
400 DEJ-100	400	270	418	100	96	10	17	86	15
450 DEJ-100	450	270	436	100	96	8	15	97	19
500 DEJ-100	500	270	436	100	98	9	14	74	23
600 DEJ-100	600	270	436	100	96	7	12	90	33
650 DEJ-100	650	385	460	100	107	12	15	76	38
700 DEJ-100	700	385	460	100	107	12	15	81	43
750 DEJ-100	750	385	460	100	107	12	15	65	50
800 DEJ-100	800	385	460	100	104	11	15	71	58
850 DEJ-100	850	385	460	100	104	11	14	73	64
900 DEJ-100	900	385	460	100	100	10	14	81	71
950 DEJ-100	950	385	460	100	100	9	12	84	79
1000 DEJ-100	1000	330	415	100	96	6	10	108	85
1100 DEJ-100	1100	330	415	100	96	5	9	113	116

Additional sizes available. Visit www.hoseflex.com for our complete range

EXPANSION JOINTS 1 2 3 4 5 6 7 8 9



EXPANSION JOINTS

Double Diesel Expansion Joint (DDEJ)

Expansion Joint - DDEJ

Part No.: DDEJ

Construction: Convoluted

Material: 304, 321, 316, Incoloy, Inconel, Nickel, Hastelloy

Profile: Medium Flexibility / Low Pressure

Liner: Standard Flow Liner

Size Available: 2" - 60"
(Larger sizes upon Request)

Temperature: -196°C +900°C

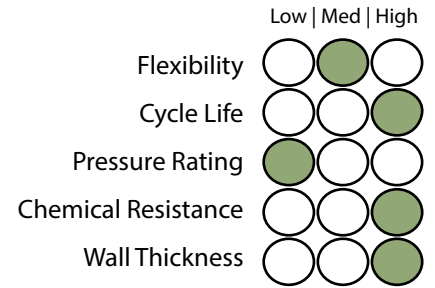

Construction

Use:

Used for absorbing large amounts of axial angular and lateral movements in low pressure pipelines. Pressure thrust will be transmitted onto pipeline. Internal flow liners for eliminating velocity & flow problems fitted as standard.



Specifications

Part Number	Nom	Length		Max. Working Pressure	Movements			Spring Rate	Pressure Thrust
	Bore	Flanged	Weld Ends		Axial	Lateral	Angular		
	(mm)	(mm)	(mm)		(mm)	(mm)	(Deg)		
50 DDEJ-100	50	380	460	100	64	76	18	11	0.4
65 DDEJ-100	65	380	460	100	64	76	18	16	0.7
80 DDEJ-100	80	380	460	100	70	76	18	6	0.9
100 DDEJ-100	100	430	526	100	76	76	18	24	1.4
125 DDEJ-100	125	430	526	100	106	130	18	25	2.0
150 DDEJ-100	150	430	576	100	106	120	18	21	2.8
200 DDEJ-100	200	450	560	100	114	98	18	14	4.7
250 DDEJ-100	250	485	582	100	112	98	18	14	7.4
300 DDEJ-100	300	555	700	100	152	114	18	14	10
350 DDEJ-100	350	540	736	100	178	114	18	30	12
400 DDEJ-100	400	540	736	100	178	114	18	43	15
450 DDEJ-100	450	540	772	100	182	102	18	49	19
500 DDEJ-100	500	540	772	100	182	102	16	37	23
600 DDEJ-100	600	540	854	100	148	86	16	45	33
650 DDEJ-100	650	690	790	100	108	72	15	72	38
700 DDEJ-100	700	690	790	100	111	72	15	82	43
750 DDEJ-100	750	690	790	100	119	70	15	71	50
800 DDEJ-100	800	690	790	100	122	64	15	74	58
850 DDEJ-100	850	690	790	100	112	60	15	79	64
900 DDEJ-100	900	690	790	100	112	59	15	87	71
950 DDEJ-100	950	690	790	100	120	57	15	93	79
1000 DDEJ-100	1000	1190	1290	100	120	54	14	121	85
1050 DDEJ-100	1050	1190	1290	100	78	68	14	127	96

Additional sizes available. Visit www.hoseflex.com for our complete range



EXPANSION JOINTS

Single Hinge Expansion Joint (HEJ)

Expansion Joint - HEJ

Part No.: HEJ

Construction: Convoluted

Material: 304, 321, 316, Incoloy, Inconel, Nickel, Hastelloy

Profile: Medium Flexibility / High Pressure

Liner: Optional

Size Available: 2" - 24"

(Larger sizes upon Request)

Temperature: -196°C +900°C

Low | Med | High

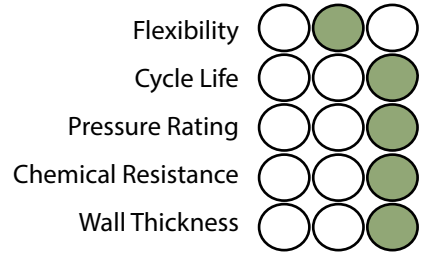

Construction

Use:

Used for absorbing angular movement in one plane only, movement of bellows is more controlled. Pressure thrust is restrained by the hinges.

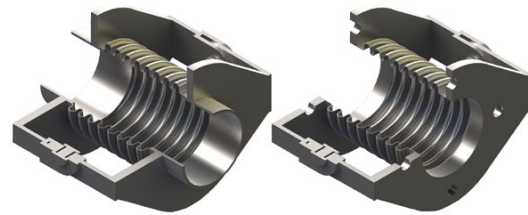

Specifications

Part Number	Nom	Length		Max. Working Pressure kPa	Movements		Spring Rate NM/Deg
	Bore	Flanged	Weld Ends		± Degrees	Total Degrees	
	(mm)	(mm)	(mm)		(mm)	(mm)	
50-HEJ-240	50	145	218	240	18	36	0.2
50-HEJ-700	50	145	218	700	18	36	0.6
50-HEJ-1400	50	145	218	1400	18	36	0.6
65-HEJ-240	65	180	234	240	18	36	0.2
65-HEJ-700	65	180	234	700	18	36	0.7
65-HEJ-1400	65	180	234	1400	18	36	1.3
80-HEJ-240	80	180	240	240	18	36	0.2
80-HEJ-700	80	180	240	700	18	36	0.6
80-HEJ-1400	80	180	240	1400	17	34	2.2
100-HEJ-240	100	190	278	240	18	36	0.3
100-HEJ-700	100	190	278	700	18	36	2.2
100-HEJ-1400	100	190	278	1400	17	34	4.6
125-HEJ-240	125	215	313	240	18	36	1.9
125-HEJ-700	125	215	313	700	18	36	3.4
125-HEJ-1400	125	215	313	1400	14	28	6.6
150-HEJ-240	150	215	338	240	18	36	2.3
150-HEJ-700	150	215	338	700	18	36	3.9
150-HEJ-1400	150	215	338	1400	14	28	18.2
200-HEJ-240	200	225	330	240	18	36	2.6
200-HEJ-700	200	255	330	700	17	34	9.8
200-HEJ-1400	200	255	330	1400	13	26	50
250-HEJ-240	250	245	341	240	18	36	4
250-HEJ-700	250	245	341	700	18	36	17

Additional sizes available. Visit www.hoseflex.com for our complete range



EXPANSION JOINTS

Double Hinge Expansion Joint (DHEJ)

Expansion Joint - DHEJ

Part No.: DHEJ

Construction: Convolute

Material: 304, 321, 316, Incoloy, Inconel, Nickel, Hastelloy

Profile: Medium Flexibility / High Pressure

Liner: Optional

Size Available: 2" - 24"

(Larger sizes upon Request)

Temperature: -196°C +900°C

Low | Med | High

Flexibility

Cycle Life

Pressure Rating

Chemical Resistance

Wall Thickness

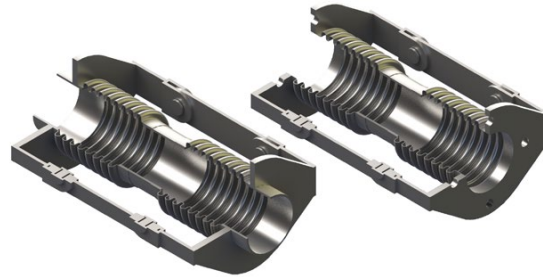

Use:

Used for absorbing large amounts of lateral movement in one plane, Movement of bellows is more controlled. Anchors only required to absorb.

Specifications

Part Number	Nom	Length		Max. Working Pressure	Movements		Spring Rate
	Bore	Flanged	Weld Ends		± Lateral	Total Lateral	
	(mm)	(mm)	(mm)		(mm)	(mm)	
50 DHEJ-240	50	600	632	240	94	188	0.1
50 DHEJ-700	50	600	632	700	94	188	0.4
50 DHEJ-1400	50	600	632	1400	94	188	0.4
65 DHEJ-240	65	600	632	240	81	162	0.3
65 DHEJ-700	65	600	632	700	81	162	0.8
65 DHEJ-1400	65	600	632	1400	81	162	1.3
80 DHEJ-240	80	600	632	240	76	152	0.3
80 DHEJ-700	80	600	632	700	76	152	1.2
80 DHEJ-1400	80	600	632	1400	76	152	4.2
100 DHEJ-240	100	600	632	240	64	128	1.4
100 DHEJ-700	100	600	632	700	64	128	2.5
100 DHEJ-1400	100	600	632	1400	64	128	5.1
125 DHEJ-240	125	600	761	240	88	176	1.6
125 DHEJ-700	125	600	761	700	88	176	2.7
125 DHEJ-1400	125	600	761	1400	88	176	5.2
150 DHEJ-240	150	619	813	240	88	176	2.2
150 DHEJ-700	150	619	813	700	88	176	3.7
150 DHEJ-1400	150	619	813	1400	88	176	16.9
200 DHEJ-240	200	698	892	240	106	212	1.8
200 DHEJ-700	200	698	892	700	106	212	6.8
200 DHEJ-1400	200	698	892	1400	106	212	35
250 DHEJ-240	250	800	994	240	112	224	3
250 DHEJ-700	250	800	994	700	112	224	17

Additional sizes available. Visit www.hoseflex.com for our complete range

EXPANSION JOINTS 1 2 3 4 5 6 7 8 9



EXPANSION JOINTS

Single Gimbal Expansion Joint (GEJ)

Expansion Joint - GEJ

Part No.: GEJ

Construction: Convoluted

Material: 304, 321, 316, Incoloy, Inconel, Nickel, Hastelloy

Profile: Medium Flexibility / High Pressure

Liner: Optional

Size Available: 2" - 24"

(Larger sizes upon Request)

Temperature: -196°C +900°C

Low | Med | High

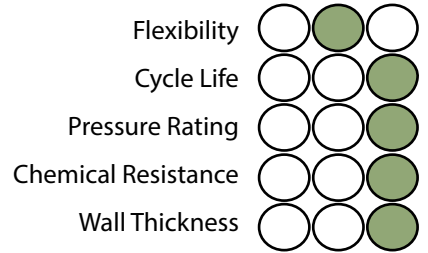

Construction

Use:

Used for absorbing angular movement in any plane, movement of bellows is more controlled. Anchors only required to absorb spring forces, must be in pairs with another gimbal. Pressure thrust is restrained by the hardware.

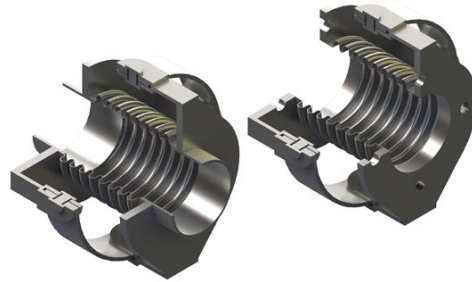

Specifications

Part Number	Nom	Length		Max. Working Pressure kPa	Movements		Spring Rate N/MM
	Bore	Flanged	Weld Ends		± Lateral	Total Lateral	
	(mm)	(mm)	(mm)		(mm)	(mm)	
50 GEJ-240	50	145	218	240	18	36	0.2
50 GEJ-700	50	145	218	700	18	36	0.6
50 GEJ-1400	50	145	218	1400	18	36	0.6
65 GEJ-240	65	180	234	240	18	36	0.2
65 GEJ-700	65	180	234	700	18	36	0.7
65 GEJ-1400	65	180	234	1400	18	36	1.3
80 GEJ-240	80	180	240	240	18	36	0.2
80 GEJ-700	80	180	240	700	18	36	0.6
80 GEJ-1400	80	180	240	1400	17	34	2.2
100 GEJ-240	100	190	278	240	18	36	1.3
100 GEJ-700	100	190	278	700	18	36	2.2
100 GEJ-1400	100	190	278	1400	17	34	4.6
125 GEJ-240	125	215	313	240	18	36	1.9
125 GEJ-700	125	215	313	700	18	36	3.4
125 GEJ-1400	125	215	313	1400	14	28	6.6
150 GEJ-240	150	215	338	240	18	36	2.3
150 GEJ-700	150	215	338	700	18	36	3.9
150 GEJ-1400	150	215	338	1400	14	28	18.2
200 GEJ-240	200	225	330	240	18	36	2.6
200 GEJ-700	200	225	330	700	17	34	9.8
200 GEJ-1400	200	225	330	1400	13	26	50
250 GEJ-240	250	245	341	240	18	36	4
250 GEJ-700	250	245	341	700	18	36	17

Additional sizes available. Visit www.hoseflex.com for our complete range



EXPANSION JOINTS

Double Gimbal Expansion Joint (DGEJ)

Expansion Joint - DGEJ

Part No.: DGEJ

Construction: Convoluted

Material: 304, 321, 316, Incoloy, Inconel, Nickel, Hastelloy

Profile: Medium Flexibility / High Pressure

Liner: Optional

Size Available: 2" - 24"

(Larger sizes upon Request)

Temperature : -196°C +900°C

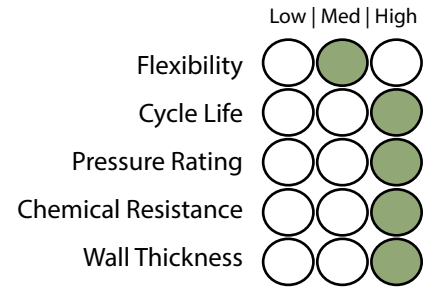

Construction

Use:

Used for absorbing large amounts of lateral movement in one plane. Movement of bellows is more controlled. Anchors only required to absorb.



Specifications

Part Number	Nom	Length		Max. Working Pressure	Movements		Spring Rate
	Bore	Flanged	Weld Ends		± Lateral	Total Lateral	
	(mm)	(mm)	(mm)		(mm)	(mm)	
50 DGEJ-240	50	600	632	240	94	188	0.1
50 DGEJ-700	50	600	632	700	94	188	0.4
50 DGEJ-1400	50	600	632	1400	94	188	0.4
65 DGEJ-240	65	600	632	240	81	162	0.3
65 DGEJ-700	65	600	632	700	81	162	0.8
65 DGEJ-1400	65	600	632	1400	81	162	1.3
80 DGEJ-240	80	600	632	240	76	152	0.3
80 DGEJ-700	80	600	632	700	76	152	1.2
80 DGEJ-1400	80	600	632	1400	76	152	4.2
100 DGEJ-240	100	600	632	240	64	128	1.4
100 DGEJ-700	100	600	632	700	64	128	2.5
100 DGEJ-1400	100	600	632	1400	64	128	5.1
125 DGEJ-240	125	600	761	240	88	176	1.6
125 DGEJ-700	125	600	761	700	88	176	2.7
125 DGEJ-1400	125	600	761	1400	88	176	5.2
150 DGEJ-240	150	619	813	240	88	176	2.2
150 DGEJ-700	150	619	813	700	88	176	3.7
150 DGEJ-1400	150	619	813	1400	88	176	16.9
200 DGEJ-240	200	760	970	240	109	218	1.8
200 DGEJ-700	200	760	970	700	109	218	6.8
200 DGEJ-1400	200	760	970	1400	109	218	35
250 DGEJ-240	250	850	1060	240	114	228	3
250 DGEJ-700	250	850	1060	700	114	228	17

Additional sizes available. Visit www.hoseflex.com for our complete range



EXPANSION JOINTS

Single Tied Expansion Joint (TEJ)

Expansion Joint - TEJ

Part No.: TEJ
Construction: Convoluted
Material: 304, 321, 316, Incoloy, Inconel, Nickel, Hastelloy
Profile: Medium Flexibility / High Pressure
Liner: Optional
Size Available: 2" - 24"
(Larger sizes upon Request)
Temperature: -196°C +900°C

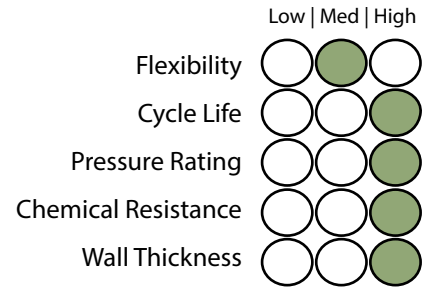

Construction

Use:
 Used for absorbing pump vibration, lateral movement and minor pipeline misalignment. Anchors required to absorb spring rate forces only. Pressure thrust is restrained by the tie rods.

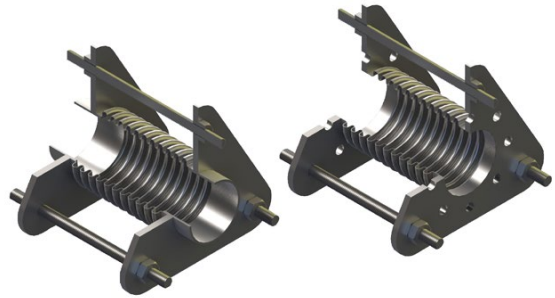

Specifications

Part Number	Nom	Length		Max. Working Pressure	Movements		Spring Rate
	Bore	Flanged	Weld Ends		± Lateral	Total Lateral	
	(mm)	(mm)	(mm)		(mm)	(mm)	
50 TEJ-240	50	145	218	240	12	24	12
50 TEJ-700	50	145	218	700	8	15	88
50 TEJ-1400	50	145	218	1400	7	13	88
65 TEJ-240	65	180	234	240	12	24	23
65 TEJ-700	65	180	234	700	11	21	70
65 TEJ-1400	65	180	234	1400	7	14	126
80 TEJ-240	80	180	240	240	13	25	18
80 TEJ-700	80	180	240	700	13	25	54
80 TEJ-1400	80	180	240	1400	8	16	198
100 TEJ-240	100	190	278	240	12	25	86
100 TEJ-700	100	190	278	700	10	20	152
100 TEJ-1400	100	190	278	1400	7	14	309
125 TEJ-240	125	215	313	240	13	26	111
125 TEJ-700	125	215	313	700	10	20	195
125 TEJ-1400	125	215	313	1400	7	14	381
150 TEJ-240	150	215	338	240	15	30	131
150 TEJ-700	150	215	338	700	9	18	228
150 TEJ-1400	150	215	338	1400	6	11	1048
200 TEJ-240	200	225	330	240	16	32	150
200 TEJ-700	200	225	330	700	9	18	562
200 TEJ-1400	200	225	330	1400	6	12	2897
250 TEJ-240	250	245	341	240	17	34	196
250 TEJ-700	250	245	341	700	10	19	855

Additional sizes available. Visit www.hoseflex.com for our complete range



EXPANSION JOINTS

Double Tied Expansion Joint (DTEJ)

Expansion Joint - DTEJ

Part No.: DTEJ
Construction: Convolute
Material: 304, 321, 316, Incoloy, Inconel, Nickel, Hastelloy
Profile: Medium Flexibility / High Pressure
Liner: Standard Flow Liner
Size Available: 2" - 24"
(Larger sizes upon Request)
Temperature: -196°C +900°C

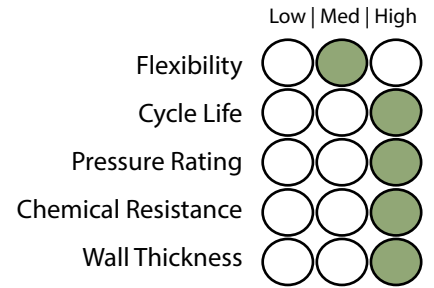

Construction

Use:
 Used for absorbing large amounts of lateral movement. Internal flow liners for eliminating velocity and flow problems may be fitted. Anchors required to absorb spring rate forces only. Pressure thrust is restrained by the tie rods.

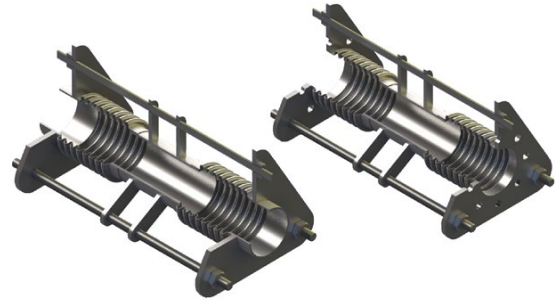

Specifications

Part Number	Nom	Length		Max. Working Pressure kPa	Movements		Spring Rate N/MM
	Bore	Flanged	Weld Ends		± Lateral	Total Lateral	
	(mm)	(mm)	(mm)		(mm)	(mm)	
50 DTEJ-240	50	600	632	240	94	188	0.1
50 DTEJ-700	50	600	632	700	94	188	0.4
50 DTEJ-1400	50	600	632	1400	94	188	0.4
65 DTEJ-240	65	600	632	240	81	162	0.3
65 DTEJ-700	65	600	632	700	81	162	0.8
65 DTEJ-1400	65	600	632	1400	81	162	1.3
80 DTEJ-240	80	600	632	240	76	152	0.4
80 DTEJ-700	80	600	632	700	76	152	1.2
80 DTEJ-1400	80	600	632	1400	76	152	4.2
100 DTEJ-240	100	600	632	240	64	128	1.4
100 DTEJ-700	100	600	632	700	64	128	2.5
100 DTEJ-1400	100	600	632	1400	64	128	5.1
125 DTEJ-240	125	600	761	240	88	176	1.6
125 DTEJ-700	125	600	761	700	88	176	2.7
125 DTEJ-1400	125	600	761	1400	88	176	5.2
150 DTEJ-240	150	619	813	240	88	176	2.2
150 DTEJ-700	150	619	813	700	88	176	3.7
150 DTEJ-1400	150	619	813	1400	88	176	16.9
200 DTEJ-240	200	698	892	240	106	212	1.8
200 DTEJ-700	200	698	892	700	106	212	6.8
200 DTEJ-1400	200	698	892	1400	106	212	35
250 DTEJ-240	250	800	994	240	112	224	3
250 DTEJ-700	250	800	994	700	112	224	17

Additional sizes available. Visit www.hoseflex.com for our complete range

9
8
7
6
5
4
3
2
1

EXPANSION JOINTS

Double Tied Expansion Joint (DTEJ)

Double Tied Expansion Joint (DTEJ)

The double tied expansion joint is well suited to allow lateral deflection in the low to medium pressure range. Used in this manner the tie rods will absorb the pressure thrust. The design may also be used to absorb axial movement but this would result in the pressure thrust being taken from the tie rods and transmitted to the anchors or adjacent equipment.

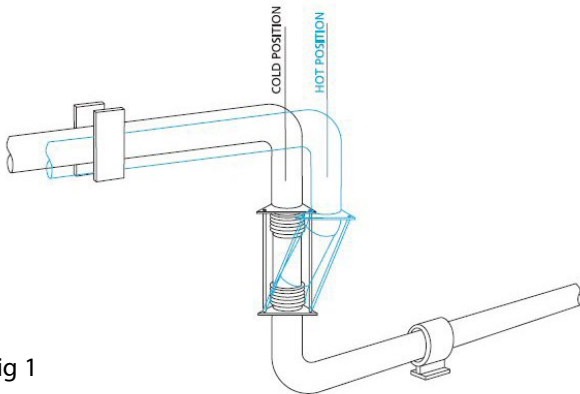

Fig 1

Fig 1 shows a double tied expansion joint used to absorb lateral deflection in a single plane. Wherever feasible the expansion joint should be designed to fill the entire leg so that the expansion of this leg is absorbed within the tie rods as axial movement.

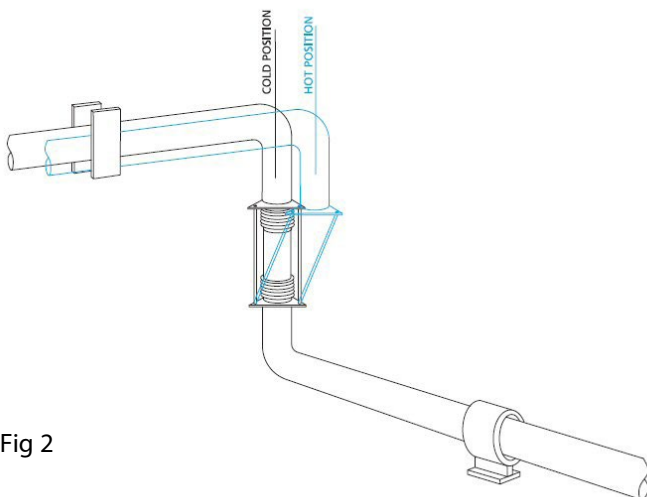

Fig 2

Fig 2 shows a double tied expansion joint used to absorb lateral deflection in a three-plane configuration. As the expansion joint will absorb lateral deflection in any direction, the two horizontal piping legs may lay at any angle in the horizontal plane.

To ensure that this style of joint is correctly installed without any thrust being transmitted to adjacent equipment, it may be necessary to utilize either double hinged or double gimbal expansion joints.

Seismic Joints and Expansion Loops

VITALFLEX® - Seismic Joints and Expansion Loops

Model name: VITALFLEX-V and VITALFLEX-U

VITALFLEX® seismic joints and expansion loops are engineered to account for the cumulative movement(s) in piping systems. The VITALFLEX® joints have been designed to counter thermal expansion/contraction, offset and rotation.

Piping used in locations subject to seismic conditions have their own set of unexpected random movements. The random motion common to earthquakes, requires that seismic expansion joints be capable of movement in any direction and are able to withstand the acceleration forces.

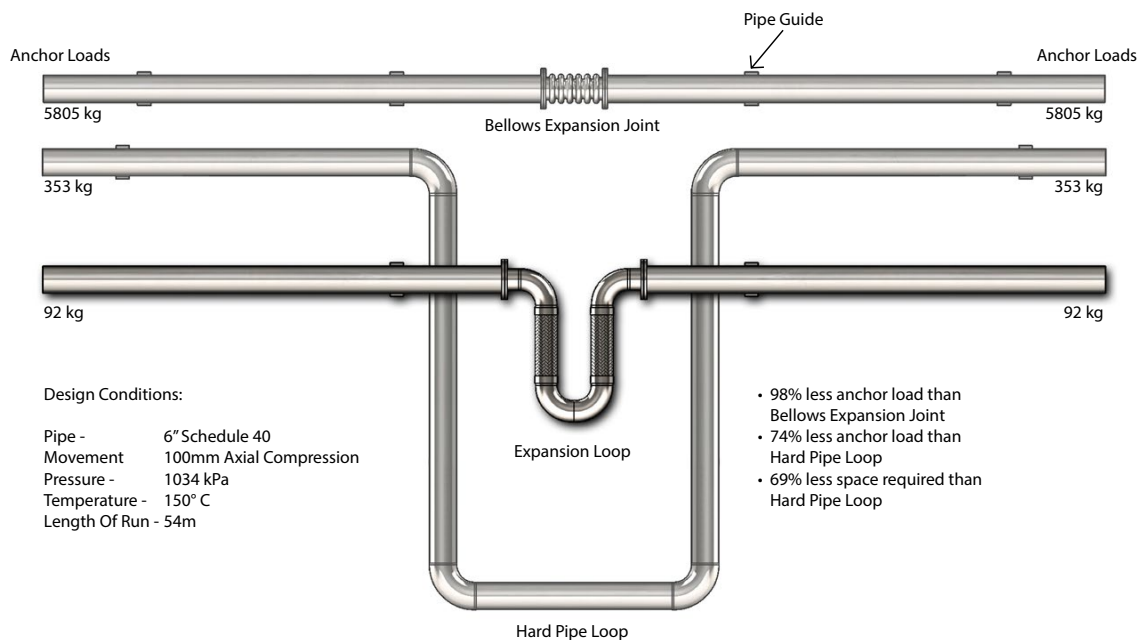

Significant cost and safety benefits found in VITALFLEX® seismic expansion joints

- It is an inexpensive alternative to dual-tied bellows expansion joints and especially ball joints
- During an earthquake, it protects equipment by allowing boilers, chillers, fan-coil units and other systems to move independently from buildings such as hospitals, high rises and stadiums
- Installation at the connection point, prevents nozzles from cracking or shearing off
- A break in the gas pipe work could start a fire and cause vast damage to the entire building. This Australian Gas Approval (AGA) certified seismic expansion joint will compensate for the movement that occurs during any seismic activity such as an earthquake
- Designed for potable water applications the VITALFLEX® joint can be Watermark certified in accordance with WMTS 520:2016

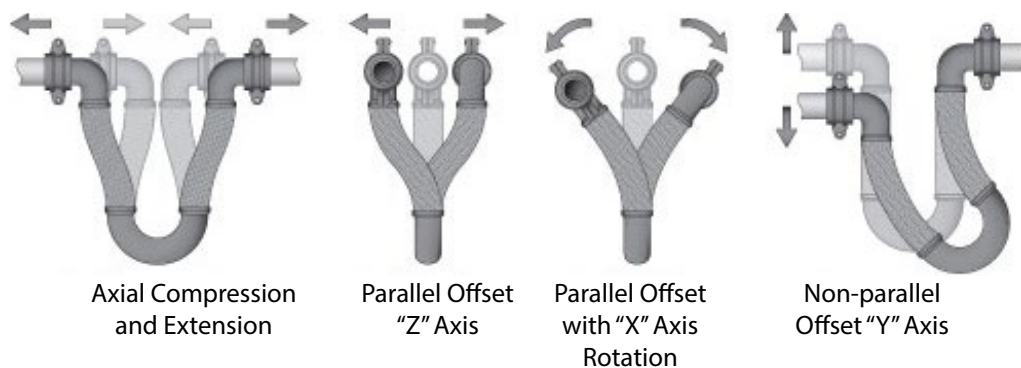

Seismic Expansion Joints

Installation Guide:

Reduce misalignment of the connecting pipes as any offset will change the design movements of the joint. When installing in any configuration other than with the product in a horizontal down position, the weight of the joint must be supported at the elbow connecting the two braided hoses. The recommended supports are wire cable or metal chain. These can be secured to the elbow used a pipe support clamp/bracket or on request to the hanging lugs which can be welded to the elbow in the manufacturing process.

Typical Installation:

HORIZONTAL
SIDE



HORIZONTAL
DOWN



HORIZONTAL
UP

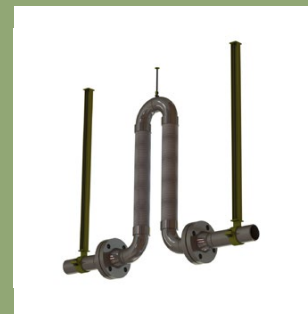

NESTED



VERTICAL



UNDER-OVER



1
2
3
4
5
6
7
8
9

EXPANSION JOINTS

Seismic Expansion Joints

Maintenance Guide:

In the event of seismic activity or if excessive movements may have been applied, the product should be inspected to ensure that it has not incurred damage.

If there is an indication of evidence that the joint may have performed movements outside the design parameters this information should be communicated to Pacific Hoseflex to assess if the joints need to be repaired or replaced.

When the joints are visible a 12 monthly inspection should occur to enforce preventative maintenance.

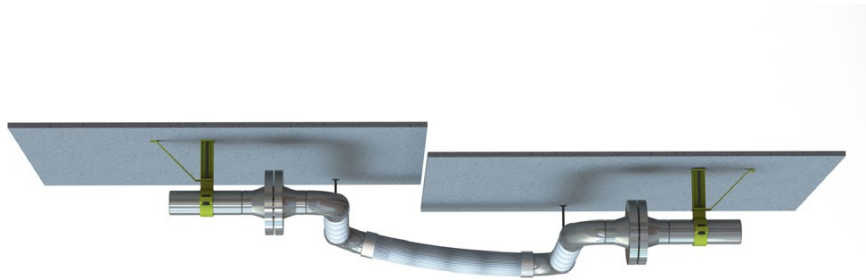
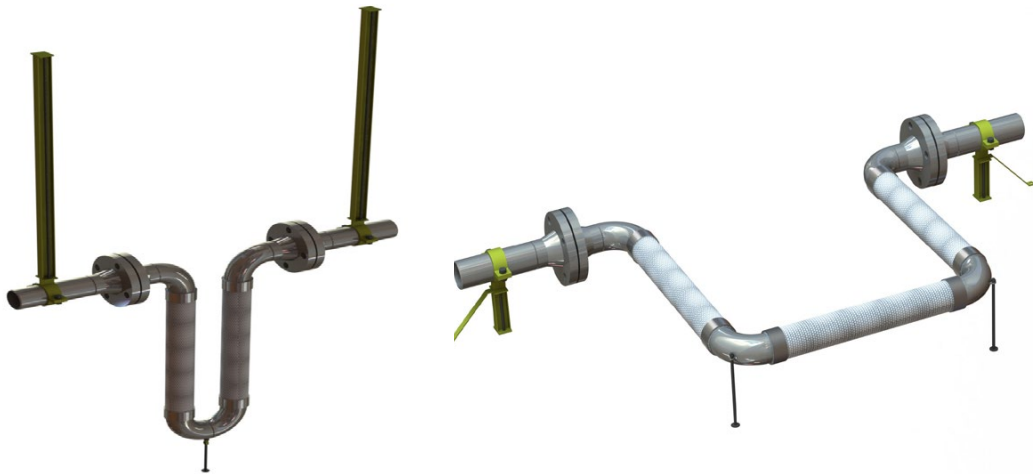

Seismic Expansion Joints

VITALFLEX® - V Shape

Construction: Annular / Close Pitch
Profile: High Flexibility / High Pressure
Material Available: 304 / 316 Stainless Steel
Braid Available: 304 / 316 Stainless Steel
Size Available: 1/4" (06mm) - 16" (500mm)
(Larger sizes upon Request)
Max Temp: 700°C

	Low	Med	High
Flexibility	<input type="radio"/>	<input type="radio"/>	<input checked="" type="radio"/>
Cycle Life	<input type="radio"/>	<input type="radio"/>	<input checked="" type="radio"/>
Pressure Rating	<input type="radio"/>	<input checked="" type="radio"/>	<input type="radio"/>
Chemical Resistance	<input type="radio"/>	<input type="radio"/>	<input checked="" type="radio"/>
Wall Thickness	<input type="radio"/>	<input checked="" type="radio"/>	<input type="radio"/>

Installations:

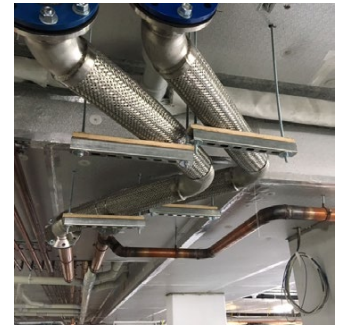

Couplings:

VITALFLEX® - Swivel Flange
Model Name: VITALFLEX-V-AF4



VITALFLEX® - Rolled groove coupling
Model Name: VITALFLEX-V-RG



VITALFLEX® - Male coupling
Model Name: VITALFLEX-V-AF1



VITALFLEX® - Female Union coupling
Model Name: VITALFLEX-V-AF12



Seismic Expansion Joints (V Shape)

Specifications

Movement range: Up to +/- 500mm
 (Standard catalogue range: 50mm, 75mm, 100mm, 150mm and 200mm)
 (Customised movement available upon request from 0 to > 500 mm)

Pressure range:

WaterMark: Full Vacuum up to 2500 kPa
 (Compressed hose may be considered for negative pressure/vacuum applications)
 (Temperature correction factors may apply)
 (Pressure restrictions may apply related to pressure rating of end fittings used)

Standards:

- Corrugated Metal Hoses: ISO 10380
- AGA Approved: AS 4631 (upon request)
- Watermark Approved: WMTS 520 (upon request)
- Welding Compliant: AS 4041- Class 1 (upon request)
- Seismic Rated: AS 1170 (upon request)
- Fire Protection Systems (upon request)

AGA (Australian Gas Association):

Full Vacuum up to 1500 kPa
 (Compressed hose may be considered for negative pressure/vacuum applications)
 (Temperature correction factors may apply)
 (Pressure restrictions may apply related to pressure rating of end fittings used)

Temperature range: -276 °C to 700 °C

(Restrictions from applicable standards for assemblies and end fittings may apply)
 (Calculated values available for single braided hose MAOP, double braided hose MAOP, 100 kPa, 500 kPa, 800 kPa, 1000 kPa, 1200 kPa,, 1500 kPa, 2000 kPa 2500 kPa)

Pressure thrust range: 0.01 kN to 147.39 kN

(Calculated values available for single braided hose MAOP, double braided hose MAOP, 100 kPa, 500 kPa, 800 kPa, 1000 kPa, 1200 kPa,, 1500 kPa, 2000 kPa 2500 kPa)

Unit weight range: Refer to technical catalogue for unfilled and filled water values
 (Available on request)

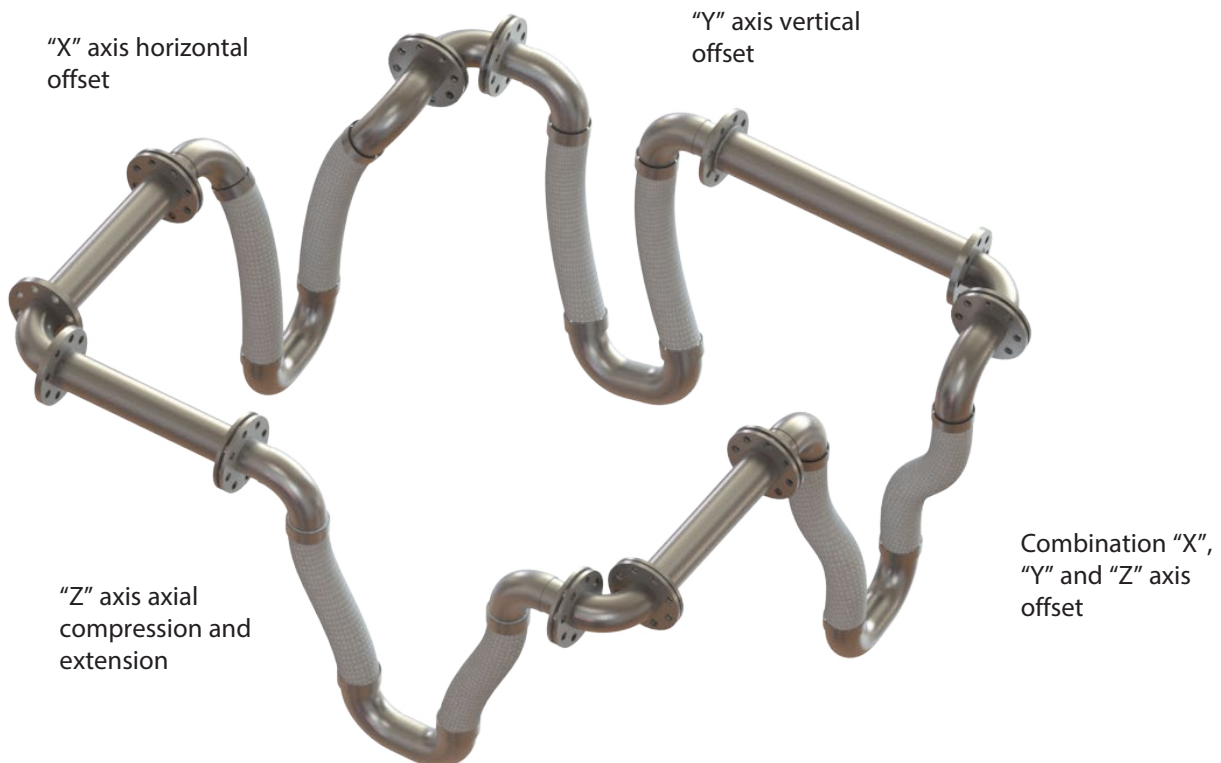



Seismic Expansion Joints

VITALFLEX® - V Shape

Construction: Annular / Close Pitch
Profile: High Flexibility / High Pressure
Material Available: 304 / 316 Stainless Steel
Braid Available: 304 / 316 Stainless Steel
Size Available: 1/4" (06mm) - 16" (500mm)
(Larger sizes upon Request)
Max Temp: 700°C

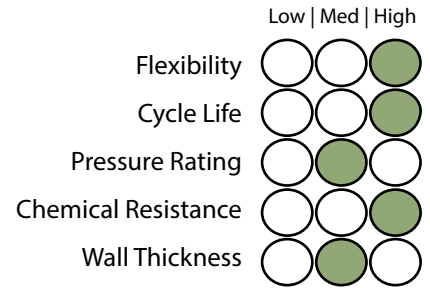

Construction

Use:
 Used in a variety of applications and locations where subject to seismic conditions or large amounts of pipework movement. The random motion common to earthquakes requires that seismic expansion joints to be capable of movement in any direction.

Standards:
 Corrugated Metal Hoses: ISO 10380
 AGA Approved: AS 4631 (upon request)
 Watermark Approved: WMTS 520 (upon request)
 Welding Compliant: AS 4041- Class 1 (upon request)
 Seismic Rated: AS 1170 (upon request)
 Seismic rated: NZS 4219 – 2009 (upon request)
 Fire Protection Systems (upon request)

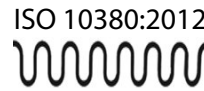

Specifications

Hose Size (mm)	Hose Size (inch)	Model	MOVEMENT (mm)	Dimension A	Dimension B	Pressure (kPa) @ 23 deg c	Hydrostatically Filled Hose weight (kg) (+/- 5%) Excluding all pipe bends and end fittings	Pneumatically Filled Hose weight (kg) (+/- 5%) Excluding all pipe bends and end fittings	Hose Spring Rate (Kg/Cm)	Hose Pipe load (kgs)
12	1/2"	VITALFLEX-V-12	50	331	150	8445	0.129	0.078	0.31	1.550
20	3/4"	VITALFLEX-V-20	50	351	160	7128	0.311	0.173	0.88	4.400
25	1"	VITALFLEX-V-25	50	367	167	5487	0.432	0.221	1.13	5.650
32	1 1/4"	VITALFLEX-V-32	50	436	198	4136	0.819	0.402	1.49	7.450
38	1 1/2"	VITALFLEX-V-38	50	483	218	3840	1.205	0.560	2.00	10.000
50	2"	VITALFLEX-V-50	50	548	242	3930	1.905	0.869	2.67	13.350
65	2 1/2"	VITALFLEX-V-65	50	684	302	2826	3.825	1.417	2.52	12.600
75	3"	VITALFLEX-V-75	50	760	333	2310	5.453	1.854	7.94	39.700
100	4"	VITALFLEX-V-100	50	915	394	1654	9.456	2.772	8.53	42.650
125	5"	VITALFLEX-V-125	50	1057	450	1316	15.457	4.392	8.59	42.950
150	6"	VITALFLEX-V-150	50	1205	508	1137	21.866	5.410	9.44	47.200
200	8"	VITALFLEX-V-200	50	1450	599	1643	39.335	9.276	24.47	122.350
250	10"	VITALFLEX-V-250	50	1734	709	1585	72.582	20.674	39.76	198.800
300	12"	VITALFLEX-V-300	50	2228	893	1110	134.914	35.626	27.76	138.800

EXPANSION JOINTS 1 2 3 4 5 6 7 8 9

Seismic Expansion Joints

VITALFLEX® - V Shape

Hose Size (mm)	Hose Size (inch)	Model	MOVEMENT (mm)	Dimension A	Dimension B	Pressure (kPa) @ 23 deg c	Hydrostatically Filled Hose weight (kg) (+/- 5%) Excluding all pipe bends and end fittings	Pneumatically Filled Hose weight (kg) (+/- 5%) Excluding all pipe bends and end fittings	Hose Spring Rate (Kg/Cm)	Hose Pipe load (kgs)
12	1/2"	VITALFLEX-V-12	100	432	200	8445	0.187	0.113	0.1	1
20	3/4"	VITALFLEX-V-20	100	460	214	7128	0.459	0.255	0.12	1.2
25	1"	VITALFLEX-V-25	100	481	225	5487	0.648	0.331	0.3	3
32	1 1/4"	VITALFLEX-V-32	100	567	264	4136	1.218	0.597	0.46	4.6
38	1 1/2"	VITALFLEX-V-38	100	623	288	3840	1.781	0.827	0.63	6.3
50	2"	VITALFLEX-V-50	100	691	314	3930	2.791	1.274	0.85	8.5
65	2 1/2"	VITALFLEX-V-65	100	860	391	2826	5.583	2.069	0.78	7.8
75	3"	VITALFLEX-V-75	100	946	426	2310	7.925	2.694	2.73	27.3
100	4"	VITALFLEX-V-100	100	1119	496	1654	13.595	3.985	2.844	28.44
125	5"	VITALFLEX-V-125	100	1275	559	1316	22.144	6.293	2.92	29.2
150	6"	VITALFLEX-V-150	100	1439	625	1137	31.238	7.729	3.2	32
200	8"	VITALFLEX-V-200	100	1697	722	1643	56.151	13.241	8.29	82.9
250	10"	VITALFLEX-V-250	100	2010	847	1585	103.327	29.431	13.69	136.9
300	12"	VITALFLEX-V-300	100	2528	1043	1110	180.028	47.539	11.45	114.5

Note :

Dimension 'A' and 'B' are approx dimensions without Fitting only and are subject to change without notice.

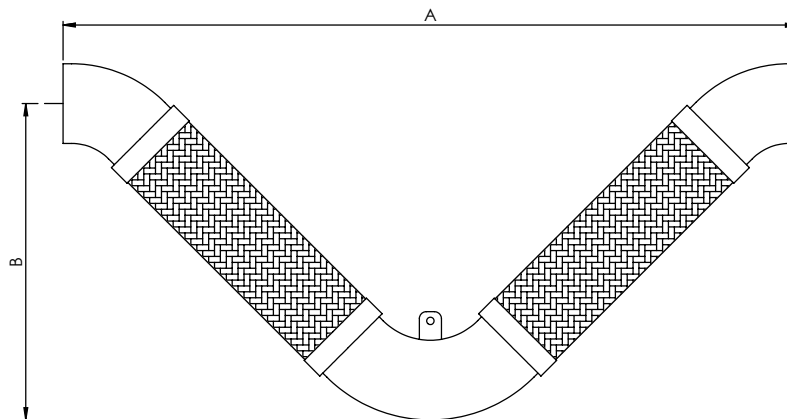

Applications



EXPANSION JOINTS

Seismic Expansion Joints

Expansion Joint - U Shape

Construction: Annular / Close Pitch
Profile: High Flexibility / High Pressure
Material Available: 304 / 316 Stainless Steel
Braid Available: 304 / 316 Stainless Steel
Size Available: 1/4" (06mm) - 16" (500mm)
(Larger sizes upon Request)
Max Temp: 700°C

	Low	Med	High
Flexibility	<input type="radio"/>	<input type="radio"/>	<input checked="" type="radio"/>
Cycle Life	<input type="radio"/>	<input type="radio"/>	<input checked="" type="radio"/>
Pressure Rating	<input type="radio"/>	<input checked="" type="radio"/>	<input type="radio"/>
Chemical Resistance	<input type="radio"/>	<input type="radio"/>	<input checked="" type="radio"/>
Wall Thickness	<input type="radio"/>	<input checked="" type="radio"/>	<input type="radio"/>

Installation:

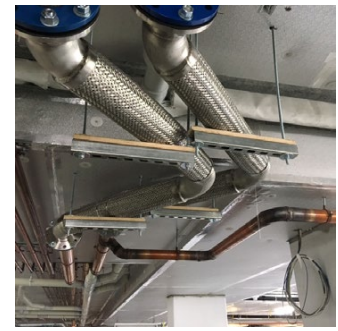

Couplings:

VITALFLEX® - Swivel Flange
Model Name: VITALFLEX-U-AF4



VITALFLEX® - Rolled groove coupling
Model Name: VITALFLEX-U-RG



VITALFLEX® - Male coupling
Model Name: VITALFLEX-U-AF1



VITALFLEX® - Female Union coupling
Model Name: VITALFLEX-U-AF12



Seismic Expansion Joints (U Shape)

Specifications

Movement range: Up to +/- 500mm

(Standard catalogue range: 50mm, 75mm, 100mm, 150mm and 200mm)

(Customised movement available upon request from 0 to > 500 mm)

Pressure range:

WaterMark: Full Vacuum up to 2500 kPa

(Compressed hose may be considered for negative pressure/vacuum applications)

(Temperature correction factors may apply)

(Pressure restrictions may apply related to pressure rating of end fittings used)

Standards:

Corrugated Metal Hoses: ISO 10380

AGA Approved: AS 4631 (upon request)

Watermark Approved: WMTS 520 (upon request)

Welding Compliant: AS 4041- Class 1 (upon request)

Seismic Rated: AS 1170 (upon request)

Fire Protection Systems (upon request)

AGA (Australian Gas Association): Full

Vacuum up to 1500 kPa

(Compressed hose may be considered for negative pressure/vacuum applications)

(Temperature correction factors may apply)

(Pressure restrictions may apply related to pressure rating of end fittings used)

Temperature range: -276 °C to 700 °C

(Restrictions from applicable standards for assemblies and end fittings may apply)

(Calculated values available for single braided hose MAOP, double braided hose MAOP, 100 kPa, 500 kPa, 800 kPa, 1000 kPa, 1200 kPa,, 1500 kPa, 2000 kPa 2500 kPa)

Pressure thrust range: 0.01 kN to 147.39 kN

(Calculated values available for single braided hose MAOP, double braided hose MAOP, 100 kPa, 500 kPa, 800 kPa, 1000 kPa, 1200 kPa,, 1500 kPa, 2000 kPa 2500 kPa)

Unit weight range: Refer to technical catalogue for unfilled and filled water values (Available on request)

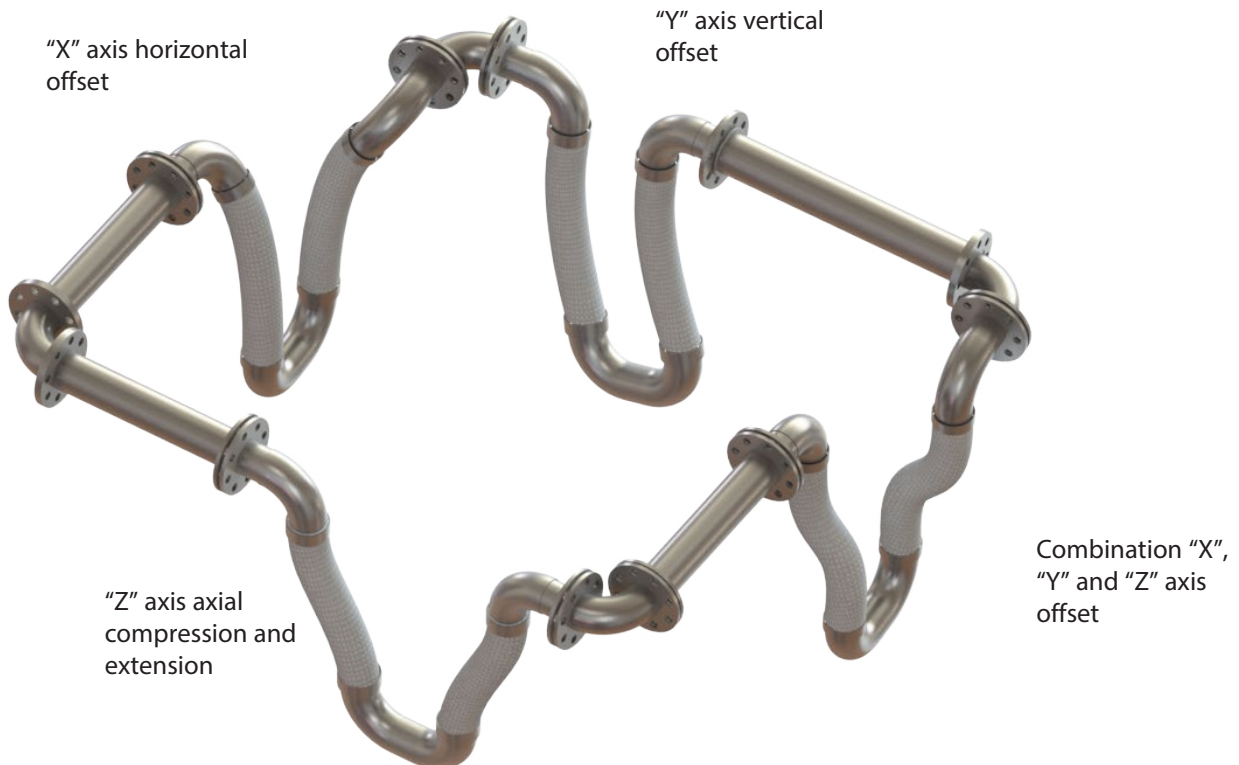



Seismic Expansion Joints

Expansion Joint - U Shape

Construction: Annular / Close Pitch
Profile: High Flexibility / High Pressure
Material Available: 304 / 316 Stainless Steel
Braid Available: 304 / 316 Stainless Steel
Size Available: 1/4" (06mm) - 16" (500mm)
(Larger sizes upon Request)
Max Temp: 700°C

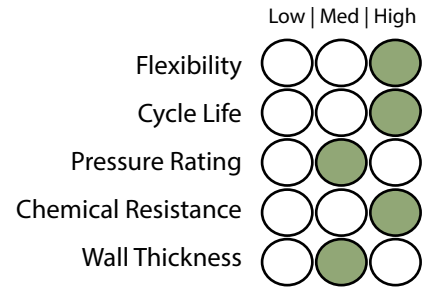

Construction

Use:
 Used in a variety of applications and locations where subject to seismic conditions or large amounts of pipework movement. The random motion common to earthquakes requires that seismic expansion joints to be capable of movement in any direction.

Standards:
 Corrugated Metal Hoses: ISO 10380
 AGA Approved: AS 4631 (upon request)
 Watermark Approved: WMTS 520 (upon request)
 Welding Compliant: AS 4041- Class 1 (upon request)
 Seismic Rated: AS 1170 (upon request)
 Seismic Rated: NZS 4219 - 2009 (upon request)
 Fire Protection Systems (upon request)

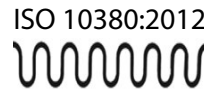

Specifications

Hose Size (mm)	Hose Size (inch)	Model	MOVEMENT (mm)	Dimension A	Dimension B	Pressure (kPa) @ 23 deg c	Hydrostatically Filled Hose weight (kg) (+/- 5%) Excluding all pipe bends and end fittings	Pneumatically Filled Hose weight (kg) (+/- 5%) Excluding all pipe bends and end fittings	Hose Spring Rate (Kg/Cm)	Hose Pipe load (kgs)
12	1/2"	VITALFLEX-U-12	50	202	245	8445	0.131	0.079	0.31	1.55
20	3/4"	VITALFLEX-U-20	50	202	262	7128	0.336	0.187	0.73	3.65
25	1"	VITALFLEX-U-25	50	202	276	5487	0.488	0.249	0.75	3.75
32	1 1/4"	VITALFLEX-U-32	50	240	329	4136	0.909	0.446	0.96	4.8
38	1 1/2"	VITALFLEX-U-38	50	279	366	3840	1.327	0.616	1.26	6.3
50	2"	VITALFLEX-U-50	50	355	417	3930	2.063	0.941	1.68	8.4
65	2 1/2"	VITALFLEX-U-65	50	381	522	2826	4.149	1.537	1.64	8.2
75	3"	VITALFLEX-U-75	50	457	582	2310	5.830	1.982	5.27	26.35
100	4"	VITALFLEX-U-100	50	610	704	1654	9.830	2.881	5.46	27.3
125	5"	VITALFLEX-U-125	50	762	817	1316	15.848	4.503	5.55	27.75
150	6"	VITALFLEX-U-150	50	914	934	1137	22.321	5.523	5.58	27.9
200	8"	VITALFLEX-U-200	50	1219	1134	1643	40.108	9.458	12.21	61.05
250	10"	VITALFLEX-U-250	50	1524	1410	1585	81.140	23.111	16.29	81.45
300	12"	VITALFLEX-U-300	50	1829	1582	1110	107.676	28.433	26.73	133.65

EXPANSION JOINTS

Seismic Expansion Joints

Expansion Joint - U Shape

Hose Size (mm)	Hose Size (inch)	Model	MOVEMENT (mm)	Dimension A	Dimension B	Pressure (kPa) @ 23 deg c	Hydrostatically Filled Hose weight (kg) (+/- 5%) Excluding all pipe bends and end fittings	Pneumatically Filled Hose weight (kg) (+/- 5%) Excluding all pipe bends and end fittings	Hose Spring Rate (Kg/Cm)	Hose Pipe load (kgs)
12	1/2"	VITALFLEX-U-12	100	252	322	8445	0.190	0.115	0.11	1.1
20	3/4"	VITALFLEX-U-20	100	252	342	7128	0.480	0.267	0.25	2.5
25	1"	VITALFLEX-U-25	100	252	357	5487	0.704	0.359	0.28	2.8
32	1 1/4"	VITALFLEX-U-32	100	290	422	4136	1.308	0.641	0.35	3.5
38	1 1/2"	VITALFLEX-U-38	100	329	465	3840	1.903	0.884	0.47	4.7
50	2"	VITALFLEX-U-50	100	405	519	3930	2.958	1.350	0.69	6.9
65	2 1/2"	VITALFLEX-U-65	100	481	646	2826	5.893	2.183	0.61	6.1
75	3"	VITALFLEX-U-75	100	557	714	2310	8.321	2.829	1.99	19.9
100	4"	VITALFLEX-U-100	100	610	849	1654	13.998	4.103	2.07	20.7
125	5"	VITALFLEX-U-125	100	762	972	1316	22.578	6.416	2.15	21.5
150	6"	VITALFLEX-U-150	100	914	1100	1137	31.749	7.855	2.27	22.7
200	8"	VITALFLEX-U-200	100	1219	1308	1643	56.924	13.424	5.47	54.7
250	10"	VITALFLEX-U-250	100	1524	1555	1585	104.119	29.657	8.83	88.3
300	12"	VITALFLEX-U-300	100	1829	1795	1110	153.002	40.403	11.62	116.2

Note :
- Dimension 'A' and 'B' are approx dimensions without Fitting only and are subject to change without notice.

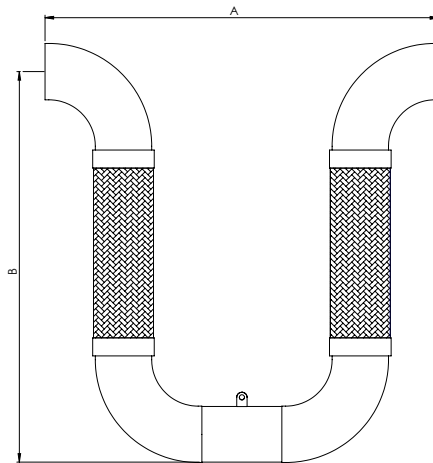

Applications



9
8
7
6
5
4
3
2
1
EXPANSION JOINTS



EXPANSION JOINTS

External Pressurised Expansion Joints

External Pressurised Expansion Joints

The XT Externally Pressurized Expansion Joint is designed so that the pressure is external to the bellows whilst the inside is at atmospheric pressure. With this design, when a pipeline expands, the expansion joint compresses, but in doing so it stretches the bellows. The result of this is that many convolutions act together to allow a large amount of axial movement because under external pressure the bellows is completely stable.

The XT style of the joint is relatively inexpensive and is designed primarily to fit the following applications:

- a) In tunnels or locations where articulated joints can not be used but where large amounts of axial expansion have to be absorbed. It would normally be less expensive to install one XT joint than to divide the pipeline up into several sets of expansion joint(s), anchors and guides. It is impractical to use more than two normal bellows together because of the tendency of the bellows to squirm once a certain length diameter ratio is exceeded.
- b) At extremely high pressure even short bellows can become unstable under internal pressure. This can be overcome by the use of an XT type joint, which has the bellows under tension and therefore stabilised.
- c) Where it is undesirable to have solids accumulate in the convolutions of an expansion joint, the XT can be fitted with drains or manholes to facilitate the regular cleaning out of these areas.



Definition of Movement

Axial Compression

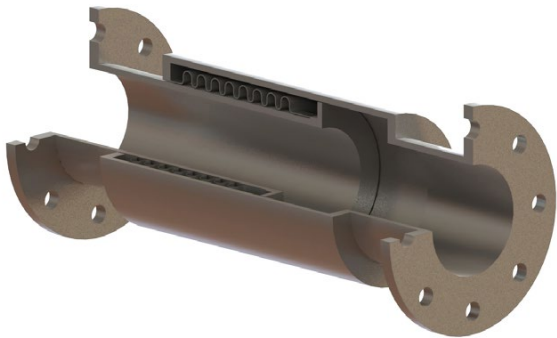
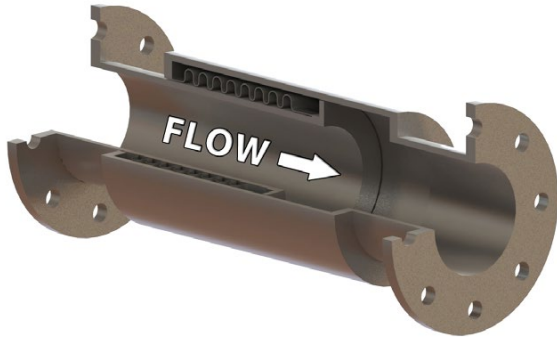

Pressure is external to the bellows for maximum stability.

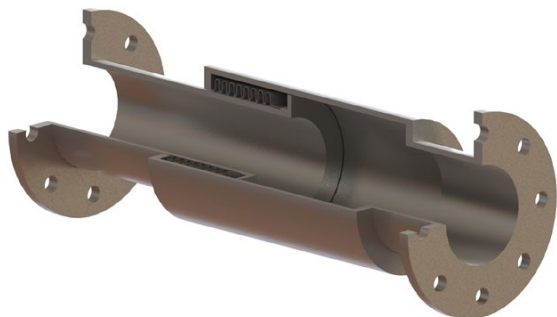

When the pipe expands, it compresses the expansion joint but extends the bellows. The bellows element remains stable due to the external pressure acting upon it.

External Pressurised Expansion Joints (XT)

Expansion Joint - XT

Part No.: XT

Construction: Convoluted

Material: 304, 321, 316, Incoloy, Inconel, Nickel, Hastelloy

Profile: High Flexibility / High Pressure

Liner: Standard Flow Liner

Size Available: 1" - 10"

(Larger sizes upon Request)

Temperature: -196°C +900°C

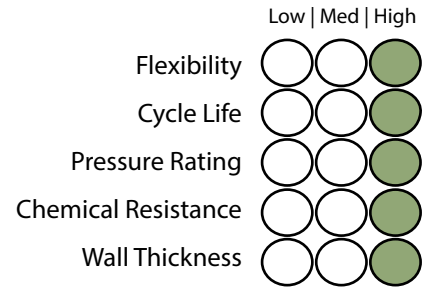

Construction

Use:

Used for absorbing thermal expansion in exhaust, gas ducting and low pressure systems. Pressure thrust will be transmitted onto pipeline. Internal flow liners for eliminating velocity and flow problems fitted as standard.

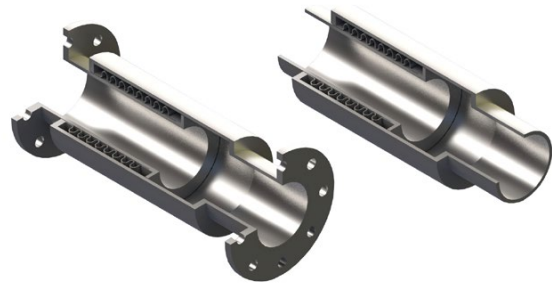

Specifications

Part Number	Nom	Length		Max. Working Pressure kPa	Movements	Pressure Thrust KN
	Bore	Flanged	Weld Ends		Axial	
	(mm)	(mm)	(mm)		(mm)	
25 XT-1000-100	25	660	660	1000	100	5.4
25 XT-1000-150	25	914	914	1000	150	5.4
25 XT-1000-200	25	1168	1168	1000	200	5.4
25 XT-2000-100	25	660	660	2000	100	11.5
25 XT-2000-150	25	914	914	2000	150	11.5
25 XT-2000-200	25	1168	1168	2000	200	11.5
40 XT-1000-100	40	660	660	1000	100	7.9
40 XT-1000-150	40	914	914	1000	150	7.9
40 XT-1000-200	40	1168	1168	1000	200	7.9
40 XT-2000-100	40	660	660	2000	100	16.6
40 XT-2000-150	40	914	914	2000	150	16.6
40 XT-2000-200	40	1168	1168	2000	200	16.6
50 XT-1000-100	50	660	660	1000	100	9.5
50 XT-1000-150	50	914	914	1000	150	9.5
50 XT-1000-200	50	1168	1168	1000	200	9.5
50 XT-2000-100	50	660	660	2000	100	19.9
50 XT-2000-150	50	914	914	2000	150	19.9
50 XT-2000-200	50	1168	1168	2000	200	19.9
65 XT-1000-100	65	660	660	1000	100	12.2
65 XT-1000-150	65	914	914	1000	150	12.2
65 XT-1000-200	65	1168	1168	1000	200	12.2
65 XT-2000-100	65	660	660	2000	100	24.6
65 XT-2000-150	65	914	914	2000	150	24.6

Additional sizes available. Visit www.hoseflex.com for our complete range



EXPANSION JOINTS

Double External Pressurised Expansion Joints (DXT)

Expansion Joint - DXT

Part No.: DXT

Construction: Convoluted

Material: 304, 321, 316, Incoloy, Inconel, Nickel, Hastelloy

Profile: High Flexibility / High Pressure

Liner: Standard Flow Liner

Size Available: 1" - 10"

(Larger sizes upon Request)

Temperature: -196°C +900°C

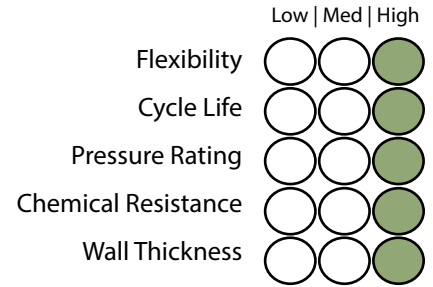

Construction

Use:

Used for absorbing thermal expansion in exhaust, gas ducting and low pressure systems. Pressure thrust will be transmitted onto pipeline. Internal flow liners for eliminating velocity and flow problems fitted as standard.



Specifications

Part Number	Nom	Length		Max. Working Pressure kPa	Movements	Pressure Thrust KN
	Bore	Flanged	Weld Ends		Axial	
	(mm)	(mm)	(mm)		(mm)	
25 DXT-1000-200	25	1220	1220	1000	200	5.4
25 DXT-1000-300	25	1727	1727	1000	300	5.4
25 DXT-2000-200	25	1220	1220	2000	200	11.5
25 DXT-2000-300	25	1727	1727	2000	300	11.5
40 DXT-1000-200	40	1220	1220	1000	200	7.9
40 DXT-1000-300	40	1727	1727	1000	300	7.9
40 DXT-2000-200	40	1220	1220	2000	200	16.6
40 DXT-2000-300	40	1727	1727	2000	300	16.6
50 DXT-1000-200	50	1220	1220	1000	200	9.5
50 DXT-1000-300	50	1727	1727	1000	300	9.5
50 DXT-1000-400	50	2235	2235	1000	400	9.5
50 DXT-2000-200	50	1220	1220	2000	200	19.9
50 DXT-2000-300	50	1727	1727	2000	300	19.9
50 DXT-2000-400	50	2235	2235	2000	400	19.9
65 DXT-1000-200	65	1220	1220	1000	200	12.2
65 DXT-1000-300	65	1727	1727	1000	300	12.2
65 DXT-1000-400	65	2235	2235	1000	400	12.2
65 DXT-2000-200	65	1220	1220	2000	200	24.6
65 DXT-2000-300	65	1727	1727	2000	300	24.6
65 DXT-2000-400	65	2235	2235	2000	400	24.6
80 DXT-1000-200	80	1220	1220	1000	200	16.7
80 DXT-1000-300	80	1727	1727	1000	300	16.7
80 DXT-1000-400	80	2235	2235	1000	400	16.7

Additional sizes available. Visit www.hoseflex.com for our complete range

PTFE Expansion Joint Design

Introduction

Pacific Hoseflex expansion joints are made of contour moulded PTFE (white or black), providing exceptional corrosion resistance and flex-life. The flexible liner is moulded over the metallic sealing face which eliminates troublesome separate gaskets and reduces the chances of bacteria build up. Different numbers of convolutions accommodate varying degrees of misalignment, axial travel and angular deflection between components.

These expansion joints have found widespread acceptance in the chemical processing industry and commercial heating and air-conditioning systems as pump connectors and at strategic points throughout systems. Because of their established record of long service life, they are the most economical vibration and sound absorbers available.

They are manufactured with integral steel limit bolts and reinforcing rings enabling the bellows to absorb vibration and allow for thermal movement and misalignment in piping. They also provide resistance to rotational forces which can lead to joint failure, offering long life in coastal, marine, and chlorine rich environments.

They are available in 2, 3 and 5 Convolution models, with varying amounts of allowed movement.

PTFE expansion joints are capable of handling all of the following movements:

- Angular misalignment - called angular deflection and angular rotation, is the displacement of one flange in relation to the other causing them to lie in non-parallel planes.
- Vibration - Absorbing movement caused by generators or pumps that may result in pipe work cracking.
- Longitudinal - also called travel or axial compression and extension.
- Parallel misalignment - called offset or lateral deflection, is the displacement of one flange in relation to the other while they lie in parallel planes.
- Maximum travel is based on installation with no misalignment or angular deflection.
- Maximum Misalignment is based on installation with no Travel or Angular Deflection.
- Combined travel and misalignment are proportionately lower for each type of deflection according to the percentage of the "maximum" that is required for the other.

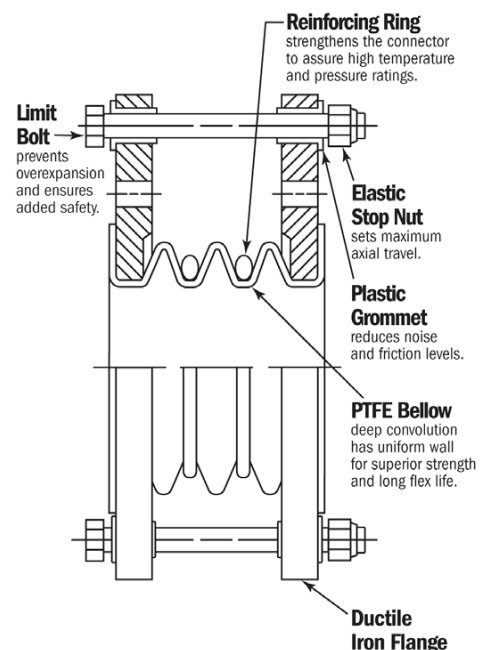

Definition of Movement

ANGULAR DEFLECTION



“Maximum Angular Deflection” may be called angular rotation. It is based on installation with no axial travel or lateral offset.

VIBRATION

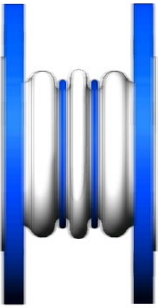

In addition to noise, vibration transmitted through piping can cause leaks, premature equipment wear and cracked welds. Expansion joints drastically reduce vibration transmission, thereby solving many of these issues.

AXIAL TRAVEL

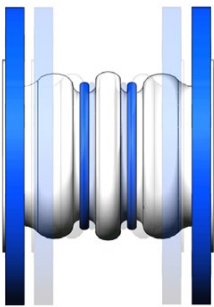

“Maximum Axial Travel” may be called longitudinal movement or axial compression and extension. It is based on installation with no misalignment or angular deflection.

MISALIGNMENT



“Maximum Misalignment” may also be referred to as lateral offset or deflection. It is based on installation with no axial travel or angular deflection.

Operating Pressure vs. Temperature

(PEJ2) 2-Convolute PTFE Expansion Joint

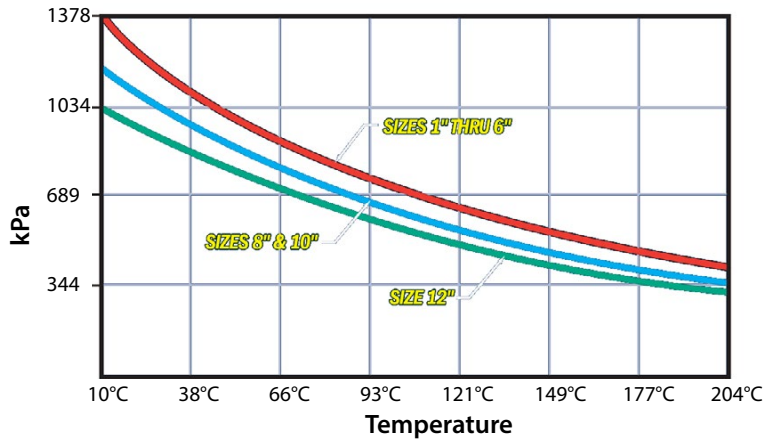

(PEJ3) Convolute PTFE Expansion Joints

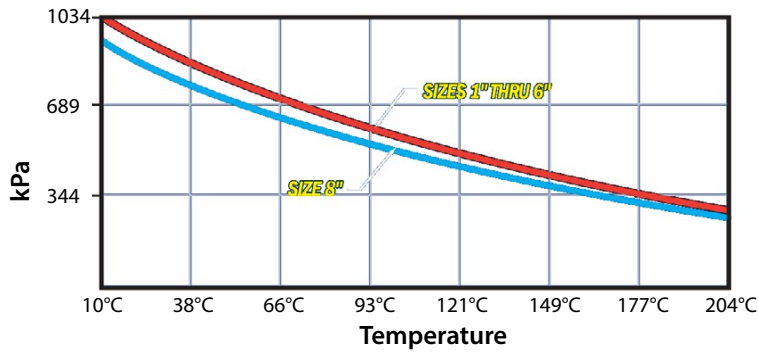

(PEJ5) Convolute PTFE Expansion Joints

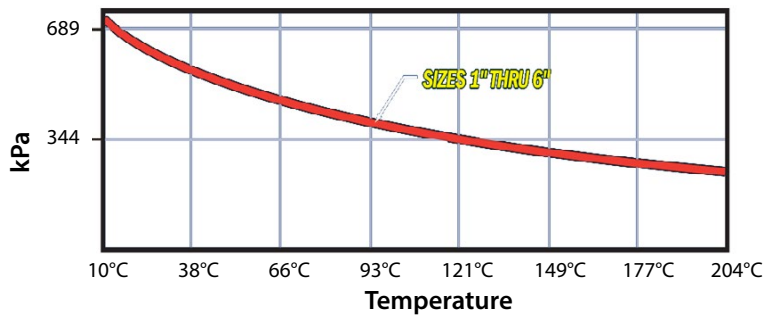

PTFE Expansion Joint 2 - Convoluted (PEJ2)

PTFE Expansion Joint - PEJ2

Part No.: PEJ2

Construction: Convoluted

Profile: High Flexibility / Medium Pressure

Liner: Optional

Size Available: 1" - 12"
(Larger sizes upon Request)

Temperature: 10°C +204°C

Low | Med | High

Flexibility

Cycle Life

Pressure Rating

Chemical Resistance

Wall Thickness

Construction

Use:

PTFE bellows are specifically designed to compensate for pipe expansion, vibration and misalignment in process piping and vessels. PTFE bellows are constructed from uniform-walled isostatically molded PTFE and demonstrate a high level of design consistency throughout the product line.

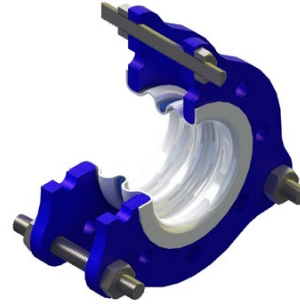

Specifications

Part Number	Nom Bore (mm)	Length (mm)	Flare Diameter (mm)	Max. Working Pressure (10°C) (kPa)	Movements		Weight (kg)
					± Maximum Travel (mm)	Maximum Misalignment (mm)	
PEJ-25-2	25	34	50	1378	6	3	1.17
PEJ-38-2	38	38	73	1378	6	3	1.63
PEJ-50-2	50	48	92	1378	6	3	3.53
PEJ-65-2	65	50	104	1378	8	3	4.89
PEJ-80-2	80	67	127	1378	10	4	5.94
PEJ-100-2	100	67	157	1378	12	6	8.25
PEJ-125-2	125	72	185	1378	17	6	10.16
PEJ-150-2	150	72	216	1378	12	6	12.56
PEJ-200-2	200	94	269	1170	20	6	18.59
PEJ-250-2	250	102	323	1170	25	6	27.26
PEJ-300-2	300	105	381	1034	25	6	40.68

*See Operating Pressure vs. Temperature graph for correction factors. Page 101

Applications





EXPANSION JOINTS

PTFE Expansion Joint 3 - Convoluted (PEJ3)

PTFE Expansion Joint - PEJ3

Part No.: PEJ3

Construction: Convoluted

Profile: High Flexibility / Medium Pressure

Liner: Optional

Size Available: 1" - 8"
(Larger sizes upon Request)

Temperature: 10°C +204°C

Low | Med | High

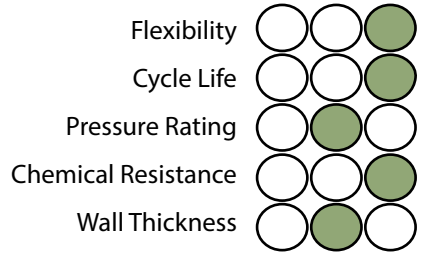

Construction

Use:

PTFE bellows are specifically designed to compensate for pipe expansion, vibration and misalignment in process piping and vessels. PTFE bellows are constructed from uniform-walled isostatically molded PTFE and demonstrate a high level of design consistency throughout the product line.

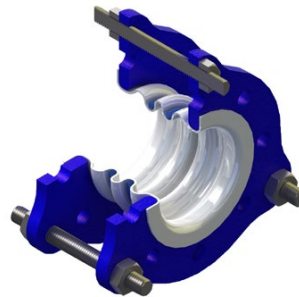

Specifications

Part Number	Nom Bore (mm)	Length (mm)	Flare Diameter (mm)	Max. Working Pressure (10°C) kPa	Movements		Weight kg
					± Maximum Travel (mm)	Maximum Misalignment (mm)	
PEJ-25-3	25	46	50	1034	12	6	1.22
PEJ-38-3	38	51	73	1034	12	6	1.85
PEJ-50-3	50	70	92	1034	20	10	3.67
PEJ-65-3	65	76	104	1034	25	10	5.08
PEJ-80-3	80	93	127	1034	25	12	6.16
PEJ-100-3	102	95	157	1034	28	12	8.57
PEJ-125-3	125	100	185	1034	28	12	10.61
PEJ-150-3	150	102	216	1034	28	4	13.19
PEJ-200-3	200	138	269	965	42	4	19.50

*See Operating Pressure vs. Temperature graph for correction factors. Page 101

Applications





EXPANSION JOINTS

PTFE Expansion Joint 5 - Convoluted (PEJ5)

PTFE Expansion Joint - PEJ5

Part No.: PEJ5

Construction: Convoluted

Profile: High Flexibility / Medium Pressure

Liner: Optional

Size Available: 1" - 6"

(Larger sizes upon Request)

Temperature: 10°C +204°C

Low | Med | High

Flexibility

Cycle Life

Pressure Rating

Chemical Resistance

Wall Thickness

Construction

Use:

PTFE bellows are specifically designed to compensate for pipe expansion, vibration and misalignment in process piping and vessels. PTFE bellows are constructed from uniform-walled isostatically molded PTFE and demonstrate a high level of design consistency throughout the product line.

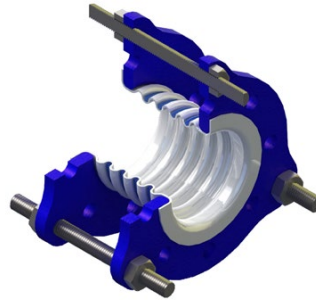

Specifications

Part Number	Nom Bore (mm)	Length (mm)	Flare Diameter (mm)	Max. Working Pressure (10°C) kPa	Movements		Weight kg
					± Maximum Travel (mm)	Maximum Misalignment (mm)	
PEJ-25-5	25	68	50	703	21	12	1.31
PEJ-38-5	38	81	73	703	27	12	1.95
PEJ-50-5	50	100	92	703	27	12	3.94
PEJ-80-5	80	125	127	703	27	12	6.71
PEJ-100-5	100	132	157	703	33	15	9.25
PEJ-150-5	150	144	216	703	39	15	14.42

*See Operating Pressure vs. Temperature graph for correction factors. Page 101

Applications



9
8
7
6
5
4
3
2
1

EXPANSION JOINTS

REJ: Rubber Expansion Joints Design

Introduction

Rubber expansion bellows can be used for both suction and delivery (discharge) due to its excellent stability and pressure capacity. Rubber Expansion Joints are generally used as connectors between vessels operating at widely different temperatures ranging up to 115°C. The sizes range from 32 mm to 500 mm including a wide variety of different flanges and materials. Most common available materials are; EPDM, Neoprene, Buna/Nitrile, PTFE Lined, Hypalon, Butyl and natural rubber.

Rubber expansion joints are generally used in heating and air conditioning systems, marine environments, sewage plants, industrial systems and for mild chemicals and oils. Rubber expansion joints permit the necessary motion and flexibility in a 'working' ship's piping system. The compactness, resilience and low stress features make them ideally suited for shipboard piping systems. Sewage treatment plants, water treatment plants and air scrubber systems all employ the use of general rubber expansion joints. Sludge pumps, raw and secondary sewage lines, centrifugal air blowers and scrub stacks use expansion joints due to their resistance to abrasion and corrosion, as well as their flexibility, making them well suited for these applications.

Nuclear and fossil fuel plants use rubber expansion joints to connect condense lines, steam turbine exhaust lines, condensate lines, cooling water lines and aeration systems.

They have been also successfully installed in demanding industrial ducting systems where flutter, heavy vibration, wet or dry corrosive materials are encountered. Rubber expansion joints reduce noise and vibration caused by forces in pumps or centrifuges by acting as a shock absorber in systems.

Thermal movement is also an important consideration in a piping system. Depending on the temperature change and length of pipe, thermal movement can easily be great enough to exceed the allowable pipe stress.

Rubber expansion joints are designed to alleviate piping stress, absorb pipe misalignment, compression and extension, noise and

vibration, in a relatively short space. Standard stock items are the single arch and the twin-sphere joints. The spherical shape arch of the connector and excellent original structural design contribute to the great success of the joint.

Combined with its internally laid tough flexible fibres and its moulding technique, rubber expansion joints have great ability to withstand the force of a creating vacuum. Internal reinforced rings can be inserted to increase the suction capabilities of the bellows.



Temperature Correction Factor					
80 °C	85 °C	90 °C	95 °C	100 °C	105 °C
x 1.0	x 0.92	x 0.83	x 0.75	x 0.67	x 0.60



REJ: Rubber Expansion Joints Installation Guide

BOLT TORQUE:

Below are the minimum recommended torque values for non-metallic expansion joints with beaded end type flanges to achieve an adequate seal:

SIZES	RECOMMENDED TORQUE
1" - 6"	10 ft./lbs.
8" - 12"	20 ft./lbs.
16" - 24"	30 ft./lbs.

NOTE:

Over torquing bolts can cause deformation of the rubber expansion joint flanges, thus resulting in possible premature failure.

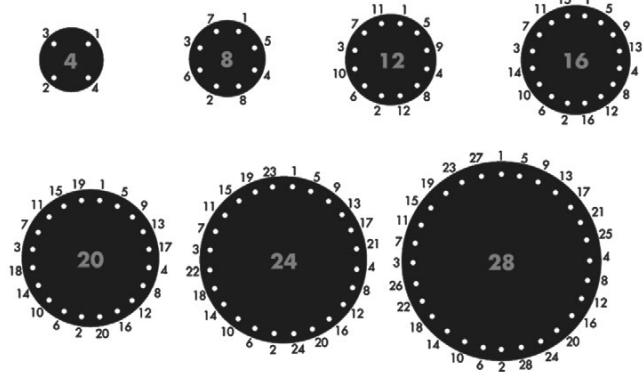

Tighten bolts in stages by alternating around the flange. Use recommended torque values above to achieve a good seal. Never tighten an expansion joint to the point that there is metal-to-metal contact between the expansion joint flange and the mating flange.

STORAGE / HANDLING:

Store expansion joints in a dry/cool location such as a warehouse. Store flange face down on a pallet or wooden platform. Do not store other heavy items on top of expansion joint(s). Ten-year shelf life can be expected with ideal conditions.

Do not lift with ropes or bars through the bolt holes. If lifting through the bore, use padding or a saddle to distribute the weight. Do not let expansion joints sit vertically on the edges of the flanges for any period of time.

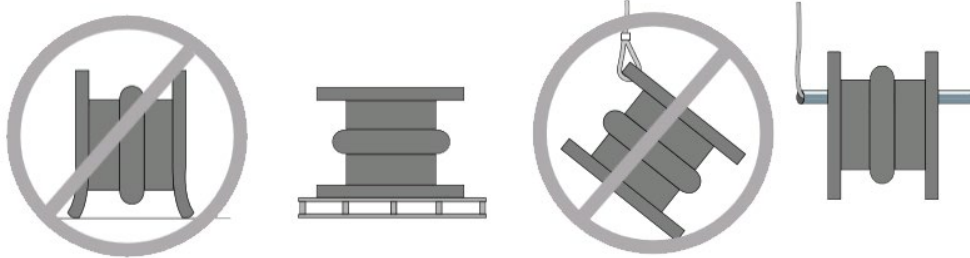

ADDITIONAL TIPS:

Insulation over a non-metallic rubber expansion joint is not recommended; however, if the insulation is required, it should be made removable to permit easy access to the flange area to check bolting.

It is acceptable (but not necessary) to lubricate the expansion joint flanges with a thin film of graphite dispersed in glycerin or water for ease of disassembly at a later time.

Do not weld in near vicinity of a non-metallic expansion joint.

If an expansion joint is to be installed underground, or will be submerged in water, contact the manufacturer for specific guidelines.

If the expansion joint will be installed outdoors, make sure the cover material will withstand ozone, sunlight, etc. Materials such as Neoprene and Chlorobutyl are recommended. Materials painted with weather resistant paint will provide additional ozone and sunlight protection.

Check the tightness of retaining rings two or three weeks after installation and retighten as necessary.

REJ: Rubber Expansion Joints Installation Guide

WARNING:

Expansion joints may operate in pipelines or equipment carrying fluids and/or gases at elevated temperatures and pressures and may transport hazardous materials. Precautions should be taken to protect personnel in the event of leakage or splash. Rubber expansion joints should not be installed in inaccessible areas where inspection is impossible

RESTRAINTS:

Restraints are used for lateral and angular compensators. The restraints absorb axial reaction force produced by inner pressure. Even so, the connected pipe must be equipped with light fixed points to absorb moving force and moments.

Precise rating details and operating parameters of the corresponding machinery or equipment must be known to correctly calculate the degree of restraints:

- Recommended on most applications to prevent damage due to excessive pipe movements
- Consists of two or more tie rods connected between pipe flanges
- Triangular end plates (gussets) have two holes for bolting securely to flange, and one hole to accommodate the connecting tie rod
- Spherical washers are incorporated to accommodate moderate piping alignments, but also assists with angular, torsional and lateral movements
- Each rod incorporates double nuts on each end to keep the expansion joint from over-elongating
- When excessive axial compression is a concern, compression nuts can be incorporated to restrict movements as needed and to protect the expansion joint from damage
- NOT designed to replace pipeline anchoring



DN 1200 Rubber Expansion Joint

RUBBER EXPANSION JOINT ROD RESTRAINTS

There are two types of tie rods restraints for lateral rubber compensators:

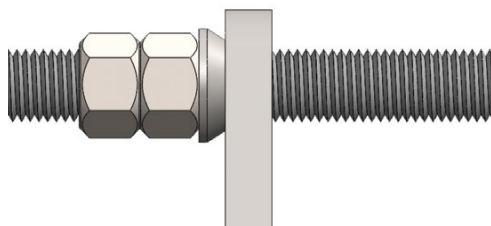
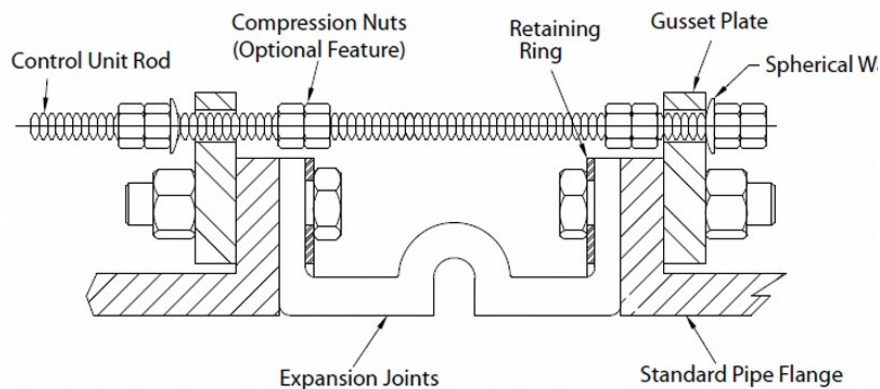

Outer restraints are used to absorb reaction force from internal pressure

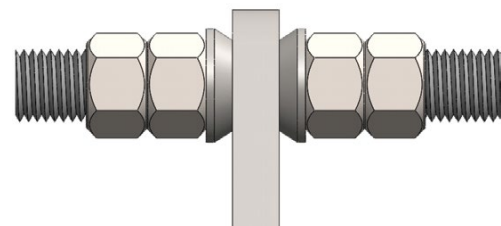

Outer and inner restraints are used to absorb reaction force from internal pressure and vacuum

REJ: Definition of Movement

Axial Compression



The dimensional reduction or shortening of the face-to-face parallel length of the joint measured along the longitudinal axis.

Axial Elongation

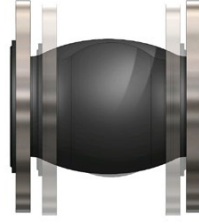

The dimensional increase or lengthening of the face-to-face parallel length of the joint measured along the longitudinal axis.

Lateral Deflection



Lateral deflection is movement perpendicular to the axial plane of the expansion joint. It is a shear motion on the bellows.

Vibration

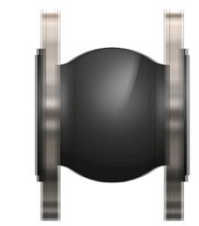

The movement of the joint due to vibrations which are effectively intercepted and insulated against transmission to the remainder of the system.

Angular Movement



The displacement of the longitudinal axis of the joint from its initial straight line position (a combination of axial elongation and axial compression).

Torsional Movement

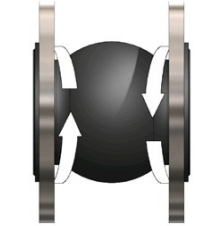

The twisting of one end of the expansion joint with respect to the other end about its longitudinal axis.

Concurrent Movements

Concurrent movements are developed when two or more movements in a pipe system occur at the same time. If multiple movements exceed single arch design there may be a need for additional arches. To perform calculation for concurrent movement when a pipe system design has more than one movement, please use the following formula:

$$\frac{\text{Actual Axial Compression} + \text{Actual Axial Extension} + \text{Actual Lateral (X)} + \text{Actual Lateral (Y)}}{\text{Rated Axial Compression} + \text{Rated Axial Extension} + \text{Rated Lateral (X)} + \text{Rated Lateral (Y)}} = / < 1$$

Calculation must be equal to or less than 1 for expansion joint to operate within concurrent movement capability.

Calculation of Thrust (Thrust Factor)

When Rubber Expansion Joints (REJs) are installed in the pipeline, the static portion of the thrust is calculated as a product of the area of the inside diameter of the arch of the REJ multiplied by the maximum pressure (design, test or surge) that will occur in the line. The result is a force expressed in pounds. Take design, surge or test pressure multiplied by the thrust factor to calculate the end thrust.

$$T = \frac{\pi}{4} (D)^2, (P)$$

T = Thrust

P = PSI (design, test or surge)

D = Arch Inside Diameter

High Suction: Rubber bellow available in Filled Spool Arch and Unfilled Spool Arch

Filled Spool Arch: Enclosed Arch style use in high suction and abrasive applications (sand and slurry)

Unfilled Spool Arch: Open arch style use in high suction and movement applications

Sphere arch (REJ): Open arch style use in standard application – Specifications on pages 109-110

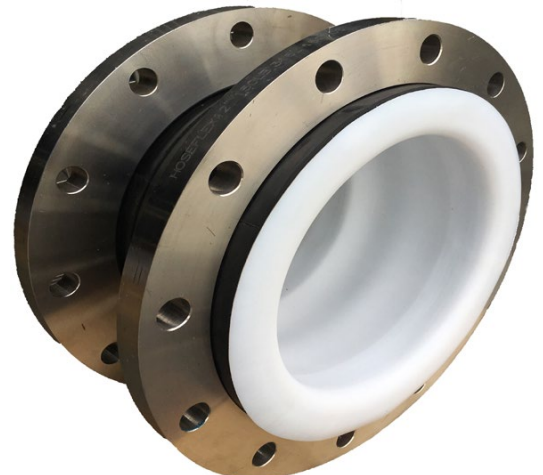



EXPANSION JOINTS

Single Sphere Rubber Expansion Joint (REJ)

Rubber Expansion Joint - REJ

Part No.: REJ

Material: E (EPDM), BN (BUNA NITRILE), V (VITON), N (NEOPRENE), H HYPERLON

Food Grade: White Nitrile (NBR) (Upon Request)

Liner: PTFE, Metallic (Upon Request)

Construction: Smoothbore Sphere

Profile: Medium Flexibility / Medium Pressure

Vacuum Ring: Available on Request **Vacuum Conversion:** 1 Torr / mmHg = 0.13 kPa or 29.88 inHg

Size Available: 1 1/4" - 24" (Larger sizes upon Request)

Temperature: -30°C +105°C

Low | Med | High

Flexibility

Cycle Life

Pressure Rating

Chemical Resistance

Wall Thickness



Construction

Use: Rubber expansion joints are designed to alleviate piping stress, absorb pipe misalignment, compression and extension, noise and vibration, in a relatively short space.

Temperature Correction Factor					
80 °C	85 °C	90 °C	95 °C	100 °C	105 °C
x 1.0	x 0.92	x 0.83	x 0.75	x 0.67	x 0.60

Specifications

Part Number (See key below)	NB (mm)	Length (mm)	Max. Working Pressure (kPa)	Movements				Spring Rates				Torsional Degrees	Vacuum (without Vacuum Ring) mmHg / Torr	Vacuum (with Vacuum Ring) mmHg / Torr
				Axial Compression	Axial Elongation	Lateral Deflection	Angular Deflection	Axial Compression	Axial Extension	Lateral Deflection	Angular Movement			
				(mm)	(mm)	(mm)	(Deg)	N/mm	N/mm	N/mm	Nm/Deg			
REJA-32-CDE	32	95	1550	8	5	8	17°	38	50	57	0.10	3	600	600
REJA-40-CDE	40	95	1550	10	5	8	14°	46	60	69	0.15	3	600	600
REJA-50-CDE	50	105	1550	10	5	8	11°	55	72	92	0.30	3	600	600
REJA-65-CDE	65	115	1550	13	7	9	11°	69	90	100	0.51	3	600	600
REJA-80-CDE	80	130	1550	13	9	12	14°	83	109	108	0.81	3	600	600
REJA-100-CDE	100	135	1550	19	12	13	14°	111	145	125	1.93	3	600	600
REJA-125-CDE	125	170	1550	19	12	13	11°	139	181	143	4	3	225	600
REJA-150-CDE	150	180	1550	19	12	13	9°	167	217	162	7	3	225	600
REJA-200-CDE	200	205	1550	25	14	22	8°	185	241	198	13	3	225	600
REJA-250-CDE	250	240	1550	25	16	22	7°	232	302	212	24	3	150	250
REJA-300-CDE	300	260	1550	25	16	22	6°	278	362	249	43	3	150	250
REJA-350-CDE	350	265	1034	25	20	22	5°	243	317	293	19	2	150	250
REJA-400-CDE	400	265	860	25	20	22	4°	278	362	338	77	2	100	150
REJA-450-CDE	450	265	860	25	20	22	4°	313	407	373	108	1	100	150
REJA-500-CDE	500	265	860	25	20	22	3°	348	452	417	155	1	100	150
REJA-600-CDE	600	265	860	25	20	22	3°	417	542	448	278	1	100	150

Part Number Key

A = RUBBER TYPE:	E (EPDM), BN (BUNA NITRILE), V (VITON), N (NEOPRENE)
B = NB SIZE:	E.G. 25 (25mm/1"), 100 (100mm/4")
C = FLANGE 1:	D (TABLE D), E (TABLE E), A1 (ANSI 150), D16 (DIN 16)
D = FLANGE 2:	D (TABLE D), E (TABLE E), A1 (ANSI 150), D16 (DIN 16)
E = FLANGE MATERIAL:	HG (GALVANISED), 6S (316 STAINLESS STEEL)

Applications





EXPANSION JOINTS

Twin Sphere Rubber Expansion Joints (TREJ) Rubber Expansion Joint - TREJ

Part No.: TREJ
Material: E (EPDM), BN (BUNA NITRILE), V (VITON), N (NEOPRENE), H (HYPERLON)
Food Grade: White Nitrile (NBR) (Upon Request)
Liner: PTFE, Metallic (Upon Request)
Construction: Smoothbore Sphere
Profile: Medium Flexibility / Medium Pressure
Vacuum Ring: Available on Request **Vacuum Conversion:** 1 Torr / mmHg = 0.13 kPa or 29.88 inHg
Size Available: 1 1/4" - 24" (Larger sizes upon Request)
Temperature: -30°C +105°C

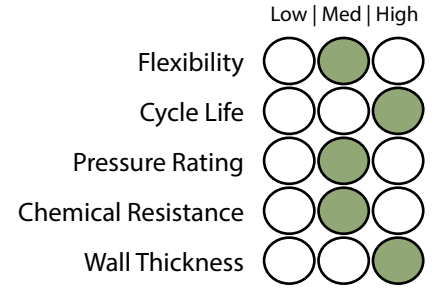

Construction

Use: Rubber expansion joints are designed to alleviate piping stress, absorb pipe misalignment, compression and extension, noise and vibration, in a relatively short space.



Temperature Correction Factor

80 °C	85 °C	90 °C	95 °C	100 °C	105 °C
x 1.0	x 0.92	x 0.83	x 0.75	x 0.67	x 0.60

Specifications

Part Number (See key below)	NB	Length	Max. Working Pressure	Movements				Spring Rates				Torsional Degrees	Vacuum (without vacuum ring)	Vacuum (with vacuum ring)
				Axial Compression	Axial Elongation	Lateral Deflection	Angular Deflection	Axial Compression	Axial Extension	Lateral Deflection	Angular Movement			
				(mm)	(mm)	(mm)	(Deg)	N/mm	N/mm	N/mm	Nm/Deg			
TREJA-32-CDE	32	175	1550	50	30	38	38	57	75	85	0.15	3	600	600
TREJA-40-CDE	40	175	1550	50	30	38	38	69	90	103	0.22	3	600	600
TREJA-50-CDE	50	175	1550	50	30	38	38	82	108	138	0.45	3	600	600
TREJA-65-CDE	65	175	1550	50	30	38	36	103	135	150	0.76	3	600	600
TREJA-80-CDE	80	175	1550	50	30	38	36	124	163	162	1.21	3	600	600
TREJA-100-CDE	100	225	1550	50	35	32	30	166	217	187	2.89	3	600	600
TREJA-125-CDE	125	225	1550	50	35	32	25	208	271	214	6	3	225	600
TREJA-150-CDE	150	225	1550	50	35	32	21	250	325	243	10	3	225	600
TREJA-200-CDE	200	325	1550	50	35	28	17	227	361	297	19	3	225	600
TREJA-250-CDE	250	325	1550	50	35	28	13	348	453	318	36	3	150	250
TREJA-300-CDE	300	325	1550	50	35	28	9	417	543	373	64	3	150	250
TREJA-350-CDE	350	350	1550	45	30	25	8	364	475	439	28	2	150	250
TREJA-400-CDE	400	350	1550	45	30	25	7	417	543	507	115	2	100	150
TREJA-450-CDE	450	350	1550	45	30	25	6	469	610	559	162	1	100	150
TREJA-500-CDE	500	350	1550	45	30	25	6	522	678	625	232	1	100	150
TREJA-600-CDE	600	350	1550	45	30	25	5	625	813	572	417	1	100	150

Part Number Key:

A = RUBBER TYPE: E (EPDM), BN (BUNA NITRILE), V (VITON), N (NEOPRENE)
 B = NB SIZE: E.G. 25 (25mm/1"), 100 (100mm/4")
 C = FLANGE 1: D (TABLE D), E (TABLE E), A1 (ANSI 150), D16 (DIN 16)
 D = FLANGE 2: D (TABLE D), E (TABLE E), A1 (ANSI 150), D16 (DIN 16)
 E = FLANGE MATERIAL: HG (GALVANISED), 6S (316 STAINLESS STEEL)

Applications



EXPANSION JOINTS

Twin Sphere Union Rubber Expansion Joints (T12REJ)

Rubber Expansion Joint - T12REJ

Part No.: T12REJ

Material: EPDM, Neoprene, Viton, Buna/Nitrile, Hyperlon, Natural Rubber

Construction: Smoothbore Sphere

Profile: Medium Flexibility / Medium Pressure

Vacuum Ring: Available on Request

Size Available: 5/8" - 3"

(Larger sizes upon Request)

Temperature: -30°C +105°C

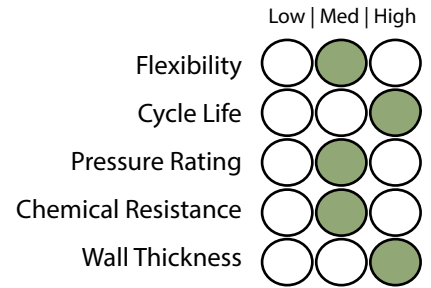

Construction

Use:

Rubber expansion joints are designed to alleviate piping stress, absorb pipe misalignment, compression and extension, noise and vibration, in a relatively short space.



Temperature Correction Factor					
80 °C	85 °C	90 °C	95 °C	100 °C	105 °C
x 1.0	x 0.92	x 0.83	x 0.75	x 0.67	x 0.60

Specifications

Part Number	Nom Bore (mm)	Length (mm)	Max. Working Pressure kPa	Movements				Vacuum mmHg
				Axial Compression (mm)	Axial Elogation (mm)	Lateral Deflection (mm)	Angular Deflection (Deg)	
				T12REJN-15-BPHG	15	203	1034	
T12REJN-20-BPHG	20	203	1034	22	6	22	32	660
T12REJN-25-BPHG	25	203	1034	22	6	22	25	660
T12REJN-32-BPHG	32	203	1034	22	6	22	25	660
T12REJN-40-BPHG	38	203	1034	22	6	22	20	660
T12REJN-50-BPHG	50	203	1034	22	6	22	15	660
T12REJN-65-BPHG	65	240	1034	22	6	22	12	660
T12REJN-80-BPHG	80	240	1034	22	6	22	10	660

* Union Is Available With BSP or NPT Thread

Applications





EXPANSION JOINTS

PTFE Lined Single Sphere Rubber Expansion Joint (REJPTFE)

PTFE Lined Rubber Expansion Joint - REJPTFE

Part No.: REJPTFE

Material: EPDM, Neoprene (CR), Viton, Buna/Nitrile, Hyperlon, Natural Rubber

Food Grade: White Nitrile (NBR) (Upon Request)

Liner: PTFE

Construction: Smoothbore Sphere

Profile: Medium Flexibility / Medium Pressure

Vacuum Ring: Available on Request

Size Available: 1 1/4" - 24" (Larger sizes upon Request)

Temperature: -15°C +115°C

Low | Med | High

Flexibility

Cycle Life

Pressure Rating

Chemical Resistance

Wall Thickness

Construction

Use: PTFE LINED Rubber expansion joints are designed to alleviate piping stress, absorb pipe misalignment, compression and extension, noise and vibration, in a relatively short space.

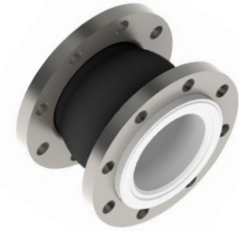

Temperature Correction Factor						
80 °C	85 °C	90 °C	95 °C	100 °C	105 °C	115 °C
x 1.0	x 0.92	x 0.83	x 0.75	x 0.67	x 0.60	x 0.45

Specifications

Part Number	Nom Bore (mm)	Length (mm)	Max. Working Pressure (kPa)	Movements				Vacuum (mmHg)
				Axial Compression (mm)	Axial Extension (mm)	Horizontal Displacement (mm)	Angular Deflection (Deg)	
				REJPTFE-32	32	95	1000	
REJPTFE-40	40	95	1000	10	6	9	15	600
REJPTFE-50	50	105	1000	10	7	10	15	600
REJPTFE-65	65	115	1000	13	7	11	15	600
REJPTFE-80	80	135	1000	15	8	12	15	600
REJPTFE-100	100	150	1000	19	10	13	15	600
REJPTFE-125	125	165	1000	19	12	13	15	225
REJPTFE-150	150	180	1000	20	12	14	15	225
REJPTFE-200	200	210	1000	25	16	22	15	150
REJPTFE-250	250	230	1000	25	16	22	15	150
REJPTFE-300	300	245	1000	25	16	22	15	150
REJPTFE-350	350	255	1000	25	16	22	15	150
REJPTFE-400	400	255	1000	25	16	22	15	100
REJPTFE-450	450	255	1000	25	16	22	15	100
REJPTFE-500	500	255	1000	25	16	22	15	100
REJPTFE-600	600	260	1000	25	16	22	15	100

Additional sizes and working pressures available, contact us for more information

Applications





EXPANSION JOINTS

Fabric Expansion Joints (FEJ)

Fabric Expansion Joint - FEJ

Part No.: FEJ

Construction: Smoothbore

Material: PVC, Neoprene, Hypalon, Butyl, Silicone, Viton, PTFE, Polyester

Cuff Styles: Rectangular, Circular

Size Available: 4" to 80"

(Larger sizes upon Request)

Temperature: -45°C +1200°C

Low | Med | High

Flexibility

Cycle Life

Pressure Rating

Chemical Resistance

Wall Thickness

Construction

Use:

Non-metallic expansion joints are flexible connectors designed to provide stress relief in ducting systems by absorbing movement caused by thermal changes. They also act as vibration isolators, shock absorbers and in some instances to make up for minor misalignment of adjoining ducting or equipment. Non-metallic expansion joints solve problems caused by the thermal and mechanical stresses generated in these complex systems.

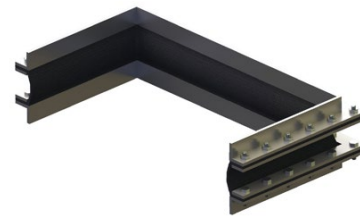

Specifications

Fabric expansion joints are widely used for a large number of industrial applications including:

- Power Plants
- Boiler Systems
- Flue Gas
- Nitrogen Oxide Reduction
- Gas Turbines
- Nuclear Power Plants
- Incinerator Plants
- Cement Industry
- Filter Systems
- Ventilators
- Ventilation Systems
- Dust Extraction Systems
- Offshore Installations
- Chemical Industry

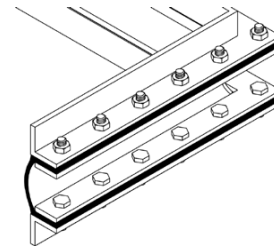

The implementation of fabric expansion joints provides a number of advantages, which are technically and economically important:

- Extremely flexible absorbing large movements
- Absorbing different movements simultaneously
- Only requiring a limited building length
- Lightweight
- Easy to handle, store, install, repair and replace
- Does not transmit noise or vibrations.
- Reducing the necessary strength of fix-points and supports
- Non corroding
- Dimensionally stable
- Cost effective

Applications





04

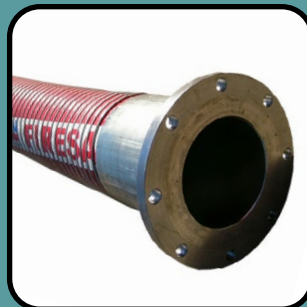
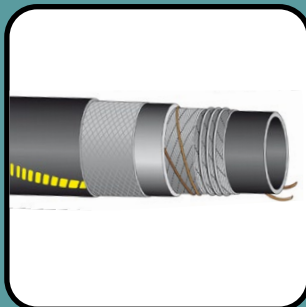
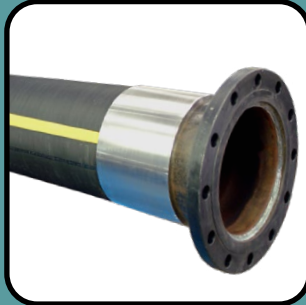

RUBBER & COMPOSITE HOSE

The Range

RUBBER HOSE - STEAM

Size: 1/2" to 4"

Page 116



RUBBER HOSE - AIR AND WATER

Size : 1/4" to 24"

Page 118



RUBBER HOSE - PETROLEUM

Size: 3/4" to 4"

Page 124



RUBBER HOSE - CHEMICAL

Size: 3/4" - 4"

Page 125

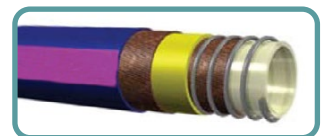

RUBBER HOSES - HOSEFLEX® MINING ABRASION RESISTANT RUBBER HOSE

Size: 2" - 48"

Page 132



RUBBER HOSE - OFFSHORE

Size : 2" to 12"

Page 146

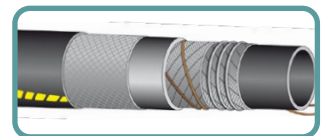

RUBBER HOSE - LPG / GAS

Size : 1/2" to 4"

Page 154



RUBBER HOSE - HYDRAULIC

Size : 3/16" to 4"

Page 158



RUBBER HOSE - HYGIENIC FOOD GRADE

Size : 1/2" to 4 5/16"

Page 164



COMPOSITE HOSE

Size : 3/4" to 12"

Page 170

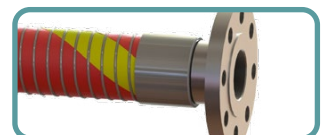

Rubber Hose - Steam

STEAM STAR R /210°C ISO6134 2B

Part No.: IH-RS-18

Colour: Red

Tube: Black, smooth, EPM rubber compound

Cover: Red, smooth, pin pricked, cloth impression EPM rubber compound, abrasion, oil, ozone and weather resistant

Reinforcement: High tensile strength steel reinforcements

Size Available: TBC

Temperature: -40°C +210°C picchi 232°C

Low | Med | High

Flexibility

Cycle Life

Pressure Rating

Chemical Resistance

Wall Thickness

Construction

Use:

Delivery hose for high pressure saturated steam, suitable for tanks and pipelines steam cleaning in the petrochemical industry. Oil resistant cover

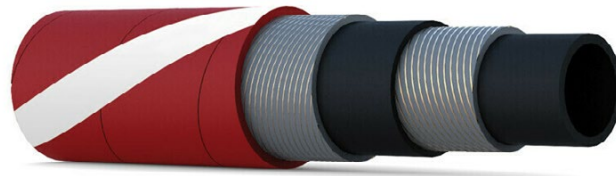

Standards

ISO 6134

Specifications

Part Number	Size	Internal Diameter	Outside Diameter	Min. Bend Radius	Max. Working Pressure		Min. Burst Pressure	
	inch	mm	mm	mm	bar	PSI	bar	PSI
IH-RS-18-12	1/2"	13	25	120	18	270	180	2700
IH-RS-18-15	5/8"	16	30	155	18	270	180	2700
IH-RS-18-20	3/4"	19	33	185	18	270	180	2700
IH-RS-18-25	1"	25	40	240	18	270	180	2700
IH-RS-18-32	1 1/4"	32	48	330	18	270	180	2700
IH-RS-18-38	1 1/2"	38	54	390	18	270	180	2700
IH-RS-18-50	2"	51	69	520	18	270	180	2700
IH-RS-18-65	2 1/2"	63	81	640	18	270	180	2700
IH-RS-18-75	3"	76	94	745	18	270	180	2700
IH-RS-18-100	4"	102	122	990	18	270	180	2700

Applications



Rubber Hose - Steam

Xtreme Steel Steam

Part No.: IH-RSS
Colour: Black
Tube: Black smooth EPDM heat resistant rubber
Cover: Red smooth EPDM heat resistant rubber
Reinforcement: Plies of steel wire cord
Size Available: 13mm - 51mm
Temperature: -40°C +236°C

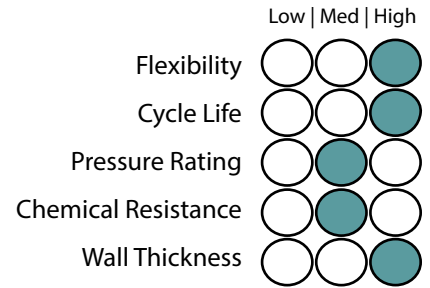

Construction

Use:
Mandrel-built, high-pressure, wire-braided steam hose designed for service with saturated steam at a maximum pressure of 12BAR (250psi). Not recommended for use on steam cleaners.



Specifications

Part Number	Nominal Dia.		Working Pressure		Weight
	I.D (mm)	O.D (mm)	Bar	kPa	Kg/M
IH-RSS-13	13	25	17	1700	0.53
IH-RSS-19	19	32	17	1700	0.68
IH-RSS-25	25	39	17	1700	0.90
IH-RSS-32	32	46	17	1700	1.30
IH-RSS-38	38	54	17	1700	1.60
IH-RSS-51	51	67	17	1700	2.20

Safety Warning:

Exposure to steam is dangerous. If not properly controlled, steam can cause damage to property, serious injury and even death. You must select the proper steam hose for the given application. Also appropriate installation, usage and maintenance of the steam hose you select will contribute to increasing operator safety.

Applications



Rubber Hose - Air and Water

Air and water multipurpose hose

Part No.: IH-RMP

Colour: Red

Tube: Black smooth Nitrile rubber, resistant to 55% aromatic content

Cover: Red smooth extruded rubber, abrasion & weather resistant

Reinforcement: Braided Synthetic Cord

Size Available: 5mm - 51mm

Temperature: -25°C +100°C

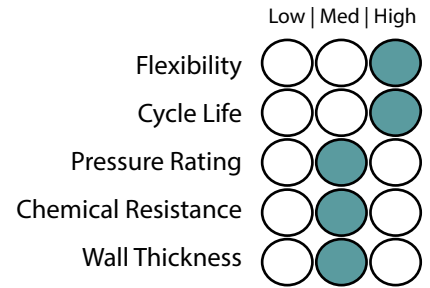

Construction

Use:

This high quality multi-purpose hose is suitable for conveying air, water, oil, petroleum and various chemicals.



Specifications

Part Number	Nominal Dia.		Working Pressure		Weight
	I.D (mm)	O.D (mm)	Bar	kPa	Kg/M
IH-RMP-05	5	12	20	2000	0.16
IH-RMP-06	6	13	20	2000	0.17
IH-RMP-08	8	15	20	2000	0.20
IH-RMP-10	10	17	20	2000	0.24
IH-RMP-12	12	21	20	2000	0.34
IH-RMP-16	16	26	20	2000	0.53
IH-RMP-19	19	29	20	2000	0.60
IH-RMP-25	25	36	20	2000	0.80
IH-RMP-32	32	44	14	1400	1.28
IH-RMP-38	38	53	14	1400	1.49
IH-RMP-51	51	63	10	1000	1.65

Applications



Rubber Hose - Air

Yellow Air

Part No.: IH-RYA

Colour: Yellow

Tube: Black smooth synthetic rubber, oil mist resistant

Cover: Yellow smooth synthetic rubber, abrasion and weather resistant

Reinforcement: Plies of high strength synthetic cord

Size Available: 19mm - 102mm

Temperature: -35°C +70°C

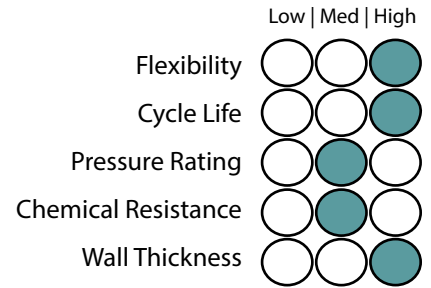

Construction

Use:

Heavy duty mandrel built air supply line. The safety yellow cover makes it ideal for use in underground mining, hire and construction applications.



Specifications

Part Number	Nominal Dia.		Working Pressure		Weight
	I.D (mm)	O.D (mm)	Bar	kPa	Kg/M
IH-RYA-19	19	31	20	2000	0.71
IH-RYA-25	25	35	20	2000	0.90
IH-RYA-32	32	44	20	2000	1.85
IH-RYA-38	38	52	20	2000	1.30
IH-RYA-51	51	66	20	2000	1.52
IH-RYA-76	76	94	20	2000	2.22
IH-RYA-102	102	121	20	2000	4.00

Applications



Rubber Hose - Air

Steel Air

Part No.: IH-RSA

Colour: Yellow

Tube: Black smooth synthetic rubber, heat and oil mist resistant

Cover: Yellow smooth synthetic rubber, abrasion and weather resistant.

Reinforcement: Plies of steel wire cord

Size Available: 19mm - 102mm

Temperature: -40°C +100°C

	Low Med High
Flexibility	<input type="radio"/> <input type="radio"/> <input checked="" type="radio"/>
Cycle Life	<input type="radio"/> <input type="radio"/> <input checked="" type="radio"/>
Pressure Rating	<input type="radio"/> <input checked="" type="radio"/> <input type="radio"/>
Chemical Resistance	<input type="radio"/> <input type="radio"/> <input checked="" type="radio"/>
Wall Thickness	<input type="radio"/> <input type="radio"/> <input checked="" type="radio"/>

Construction

Use:

This steel reinforced heavy-duty air hose is suited to the most severe mining and industrial applications. The high margin of safety gives a long trouble-free service.



Specifications

Part Number	Nominal Dia.		Working Pressure		Weight
	I.D (mm)	O.D (mm)	Bar	kPa	Kg/M
IH-RSA-19	19	31	50	5000	0.74
IH-RSA-25	25	38	45	4500	0.91
IH-RSA-32	32	45	45	4500	1.19
IH-RSA-38	38	56	40	4000	1.51
IH-RSA-51	51	69	40	4000	2.40
IH-RSA-63	63	81	35	3500	2.90
IH-RSA-76	76	95	35	3500	4.68
IH-RSA-102	102	120	30	3000	7.34

Applications



Rubber Hose - Water

Water Delivery

Part No.: IH-RWD
Colour: Black
Tube: Black smooth synthetic rubber
Cover: Black smooth synthetic rubber, abrasion and weather resistant
Reinforcement: Plies of high strength synthetic cord
Size Available: 12mm - 204mm
(Larger sizes upon Request)
Temperature: -35°C +70°C

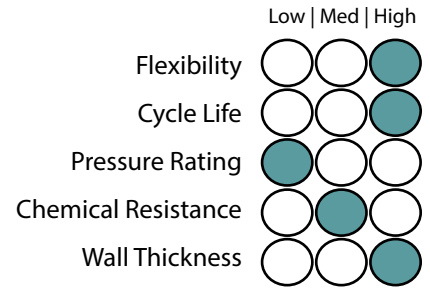

Construction

Use:
 Medium-duty mandrel built rubber hose suited for general purpose industrial water transfer applications.



Specifications

Part Number	Nominal Dia.		Working Pressure		Weight
	I.D (mm)	O.D (mm)	Bar	kPa	Kg/M
IH-RWD-12	12	-	10	1000	0.35
IH-RWD-19	19	28	10	1000	0.54
IH-RWD-25	25	34	10	1000	0.66
IH-RWD-32	32	42	10	1000	0.93
IH-RWD-38	38	48	10	1000	1.07
IH-RWD-44	44	54	10	1000	1.39
IH-RWD-51	51	61	10	1000	1.43
IH-RWD-57	57	68	10	1000	1.65
IH-RWD-64	64	74	10	1000	1.81
IH-RWD-70	70	82	10	1000	2.18
IH-RWD-76	76	89	10	1000	2.30
IH-RWD-89	89	98	10	1000	3.13
IH-RWD-102	102	114	10	1000	3.75
IH-RWD-114	114	127	10	1000	3.91
IH-RWD-127	127	140	10	1000	4.12
IH-RWD-152	152	165	8	800	4.88
IH-RWD-204	204	213	8	800	7.74

Applications



Rubber Hose - Water

Water Suction

Part No.: IH-RWS

Colour: Black

Tube: Black smooth synthetic rubber

Cover: Black smooth synthetic rubber, abrasion and weather resistant

Reinforcement: Braided synthetic cord incorporating a steel wire helix

Size Available: 19mm - 305mm

Temperature: -20°C +80°C

Low | Med | High

Flexibility

Cycle Life

Pressure Rating

Chemical Resistance

Wall Thickness

Construction

Use:

A medium-duty suction hose suitable for use in agricultural, construction and mining industries. The hose is suitable for water, sea water and light slurry in both negative and positive pressure applications.



Specifications

Part Number	Nominal Dia.		Working Pressure		Weight
	I.D (mm)	O.D (mm)	Bar	kPa	Kg/M
IH-RWS-19	19	31	10	1000	-
IH-RWS-25	25	36	10	1000	0.76
IH-RWS-32	32	43	10	1000	0.92
IH-RWS-38	38	49	10	1000	1.20
IH-RWS-44	44	56	10	1000	1.48
IH-RWS-51	51	63	10	1000	1.79
IH-RWS-57	57	70	10	1000	1.90
IH-RWS-64	64	77	10	1000	2.27
IH-RWS-76	76	89	10	1000	2.65
IH-RWS-89	89	102	10	1000	3.50
IH-RWS-102	102	118	10	1000	5.10
IH-RWS-114	114	132	10	1000	6.50
IH-RWS-127	127	146	10	1000	8.10
IH-RWS-152	152	170	5	500	9.30
IH-RWS-204	204	223	5	500	14.60
IH-RWS-254	254	282	5	500	19.20
IH-RWS-305	305	335	5	500	25.60

Applications



Rubber Hose - Water

Rubber Extruded Fire Hose

Part No.: IH-FIRE

Colour: Orange

Tube: High-tenacity yarns and covering the textile reinforcement with a synthetic rubber

Size Available: 38mm and 64mm

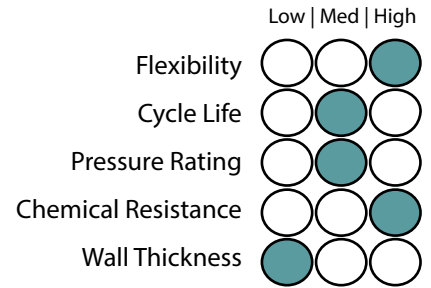

Construction

Use:

Professional firefighting hose. The high-pressure fire hose is suitable for abrasion and chemical resistant.



Standards:

AS2792

BS6391

Specifications

Part Number	Normal Diameter	Working Pressure	Minimum Burst Pressure	Mass per Metre	30m Coil Diameter
	I.D (mm)	kPa	kPa	kg	m
IH-FIRE-38	38	2100	6000	0.33	0.47
IH-FIRE-64	64	2100	5500	0.55	0.49

9
8
7
6
5
4
3
2
1

RUBBER & COMPOSITE HOSE

Applications



Rubber Hose - Petroleum

Petroleum Delivery

Part No.: IH-RPD

Colour: Black

Tube: Black smooth synthetic rubber, 50% aromatic content

Cover: Black smooth oil resistant rubber

Reinforcement: Plies of high strength synthetic cord with copper anti-static wire

Size Available: 19mm - 102mm

Temperature: -20°C +80°C

Low | Med | High

Flexibility

Cycle Life

Pressure Rating

Chemical Resistance

Wall Thickness

Construction

Use:

Medium-duty, mandrel-built hose suited for the transfer of oil and petroleum-based products up to 30% aromatic content.



Specifications

Part Number	Nominal Dia.		Working Pressure		Weight
	I.D (mm)	O.D (mm)	Bar	kPa	Kg/M
IH-RPD-19	19	30	10	1000	0.58
IH-RPD-25	25	36	10	1000	0.64
IH-RPD-32	32	44	10	1000	0.88
IH-RPD-38	38	48	10	1000	1.07
IH-RPD-44	44	54	10	1000	1.36
IH-RPD-51	51	61	10	1000	1.43
IH-RPD-64	64	74	10	1000	1.81
IH-RPD-76	76	88	10	1000	2.39
IH-RPD-102	102	114	10	1000	3.75

Applications



Rubber Hose - Chemical

Chemical Suction

Part No.: IH-RCS

Colour: Blue

Tube: White smooth, ultra high molecular weight polyethylene

Cover: Blue smooth wrapped EPDM/SBR rubber, abrasion and weather resistant

Reinforcement: High strength synthetic cord plus wire helix and anti-static copper wire

Size Available: 19mm - 102mm

Temperature: -20°C +80°C

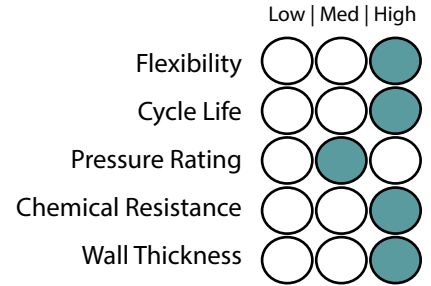

Construction

Use:

Special multi-purpose food quality suction and delivery hose, suitable for oily or fatty foods. Excellent for beer, wine, spirits up to 98% concentration. Also suitable for conveying a wide range of chemicals.

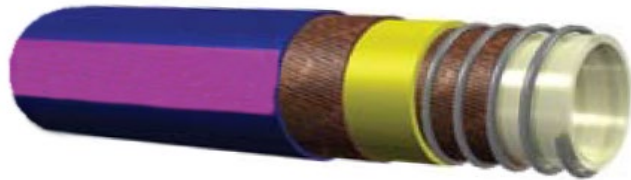

Standards:

FDA Standards

Specifications

Part Number	Nominal Dia.		Working Pressure		Bend Radius	Weight
	I.D (mm)	O.D (mm)	Bar	kPa	mm	Kg/M
IH-RCS-19	19	31	16	1600	65	0.66
IH-RCS-25	25	38	16	1600	70	0.80
IH-RCS-32	32	44	16	1600	90	0.90
IH-RCS-38	38	51	16	1600	100	1.25
IH-RCS-51	51	65	16	1600	135	1.66
IH-RCS-64	64	78	16	1600	170	2.10
IH-RCS-76	76	92	16	1600	205	2.72
IH-RCS-102	102	118	16	1600	275	4.08

Applications



Rubber Hose - Chemical

Chemmonia /25

Tube: Black, smooth, EPDM antistatic rubber compound

Cover: Black, smooth, antistatic cloth impression EPDM rubber compound, resistant to chemical products, ozone and weathering

Reinforcement: High strength synthetic plies

Temperature: -40C +120°C

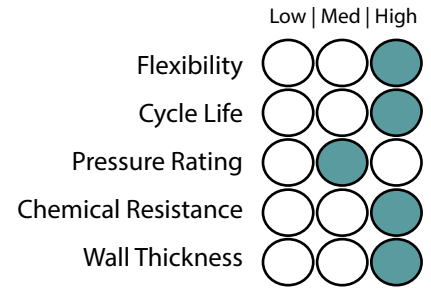

Construction

Use:

Delivery hose for the transfer of anhydrous ammonia: it is used for the production of fertilizers (main use); the remaining part is used in the production of plastics, synthetic fibres, explosives, drugs, solvents and refrigerants.



Specifications

Part Number	Size	Internal Diameter	Outside Diameter	Min. Bend Radius	Max. Working Pressure		Min. Burst Pressure	
	inch	mm	mm	mm	bar	PSI	bar	PSI
IH-RD-AMMO-NIA-20	3/4"	19	31	95	25	375	125	1875
IH-RD-AMMO-NIA-25	1"	25	37	125	25	375	125	1875
IH-RD-AMMO-NIA-32	1 1/4"	32	44	160	25	375	125	1875
IH-RD-AMMO-NIA-38	1 1/2"	38	51	228	25	375	125	1875
IH-RD-AMMO-NIA-51	2"	51	67	300	25	375	125	1875
IH-RD-AMMO-NIA-76	3"	76	92	470	25	375	125	1875

Applications



Rubber Hose - Chemical

CHEMIGREN SD /16 - EN 12115 – NO SPARKS

Part No.: IH-RSD-16

Colour: Black

Tube: Black, conductive UHMWPE

Cover: Black, smooth, fire proof and antistatic (R<106 Ohm/m), cloth impression CR rubber compound, resistant to chemical products, ozone and weather

Reinforcement: High strength synthetic plies, with steel spirals and 2 crossing copper wires for hose grounding

Size Available: Various

Temperature: -20°C +100°C

Low | Med | High

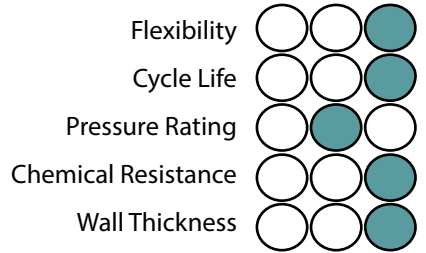

Construction

Use:

Suction and delivery hose for chemicals, oils and fuels, for bunkering

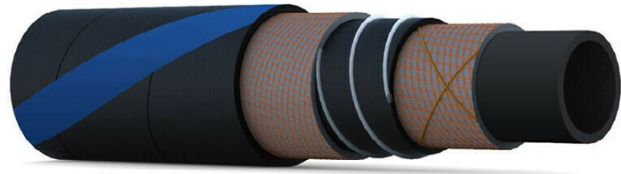

Standards

BS EN 12115

Specifications

Part Number	Size	Internal Diameter	Outside Diameter	Min. Bend Radius	Max. Working Pressure		Min. Burst Pressure		Vacuum
	inch	mm	mm	mm	bar	PSI	bar	PSI	mm hg
IH-CRSD-16-20	3/4"	19	31	125	16	240	64	960	0.9
IH-CRSD-16-25	1"	25	37	150	16	240	64	960	0.9
IH-CRSD-16-32	1 1/4"	32	44	175	16	240	64	960	0.9
IH-CRSD-16-38	1 1/2"	38	51	225	16	240	64	960	0.9
IH-CRSD-16-50	2"	51	57	275	16	240	64	960	0.9
IH-CRSD-16-65	2 1/2"	63.5	80	300	16	240	64	960	0.9
IH-CRSD-16-75	3"	76	92	350	16	240	64	960	0.9
IH-CRSD-16-100	4"	102	118	450	12	180	48	720	0.9

Applications



1 2 3 4 5 6 7 8 9

RUBBER & COMPOSITE HOSE

Rubber Hose - Chemical

Rubber FEP Liner

Part No.: RFEP

Colour: Green / Yellow Labelling

Tube: FEP liner

Cover: Green EPDM rubber cover, covered and reinforced with multi-layered rubber

Reinforcement: Spiral-wound polyester cords and a double helix wire

Size Available: 1/2" - 6"

Temperature: -40°C +177°C

Vacuum Resistance: Full Vacuum

Low | Med | High

Flexibility

Cycle Life

Pressure Rating

Chemical Resistance

Wall Thickness

Construction

Use:

Designed for extended use in hostile environments involving severe chemical, thermal, and mechanical stresses. Does not suffer aging or embrittlement, even with extreme thermal cycling.



Standards

Pharmacopoeia Class VI, USDA, FDA-approved

Specifications

Part Number	Nominal Dia.		Working pressure		Vacuum Rating	Min Bend Radius	Weight Per Mtr
	Inches	O.D (mm)	kPa	Bar	in. Hg	mm	Kg
RFEP-12	1/2"	24.13	2413	24	29.9	67.31	0.15
RFEP-20	3/4"	31.75	2413	24	29.9	88.90	0.23
RFEP-25	1"	39.37	3102	31	29.9	101.60	0.32
RFEP-32	1 1/4"	44.45	2585	25	29.9	215.90	0.40
RFEP-38	1 1/2"	54.10	2585	24	29.9	266.70	0.44
RFEP-50	2"	68.07	2068	20	29.9	330.20	0.62
RFEP-75	3"	96.52	1723	17	29.9	533.40	1.15
RFEP-100	4"	127.00	1206	12	29.9	990.60	1.58
RFEP-150	6"	181.10	689	7	29.9	1473.20	2.15

Encapsulated fitting options:

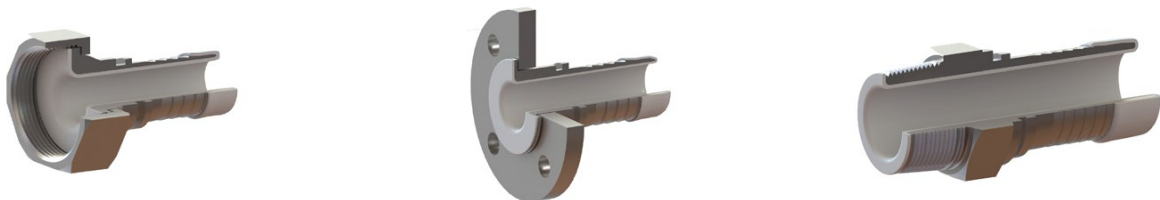

Applications



Rubber Hose - Chemical

Muff Coupling

Part No.: IH-RMC

Colour: Black

Tube: Black smooth abrasion resistant rubber

Cover: Black smooth synthetic rubber, abrasion and weather resistant

Reinforcement: Plies of high strength synthetic cord incorporating a steel wire helix

Size Available: 51mm - 354mm

Temperature: -35°C +70°C

Low | Med | High

Flexibility

Cycle Life

Pressure Rating

Chemical Resistance

Wall Thickness

Construction

Use:

Suction and delivery of abrasive slurry in mining and extractive industries. Muff Coupling hose has many advantages over conventional material handling hoses which have inbuilt flanges.



Specifications

Part Number	Nominal Dia.		Working Pressure		Weight
	I.D (mm)	O.D (mm)	Bar	kPa	
IH-RMC-51	51	71	7	700	4.90
IH-RMC-64	64	81	7	700	5.88
IH-RMC-75	75	103	7	700	6.90
IH-RMC-102	102	128	7	700	8.60
IH-RMC-127	127	157	7	700	8.95
IH-RMC-152	152	182	7	700	10.15
IH-RMC-204	204	236	7	700	14.80
IH-RMC-254	254	288	7	700	20.30
IH-RMC-305	305	344	7	700	34.36
IH-RMC-354	354	390	7	700	39.11

9
8
7
6
5
4
3
2
1

RUBBER & COMPOSITE HOSE

Applications

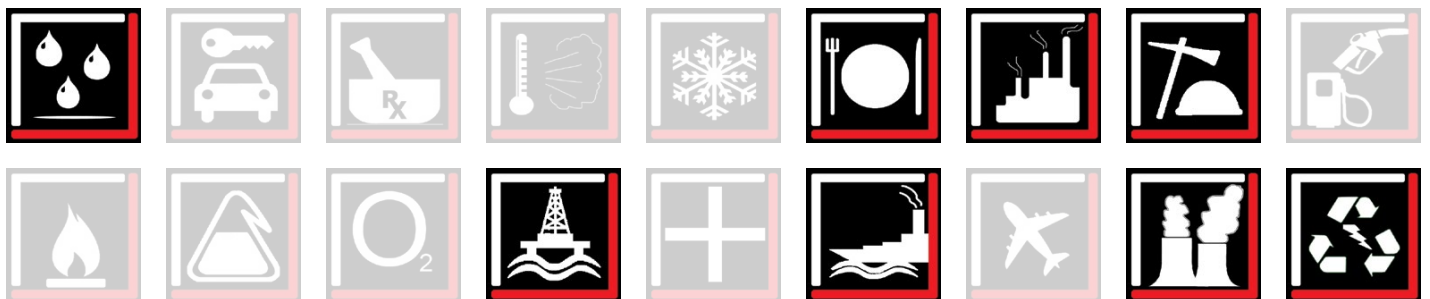

Rubber Hose - Chemical

FRAS Suction

Part No.: IH-RFS

Colour: Black

Tube: FRAS black smooth synthetic rubber, oil mist resistant

Cover: FRAS black smooth synthetic rubber, abrasion and weather resistant

Reinforcement: Plies of high strength synthetic cord incorporating a steel wire helix.

Size Available: 25mm - 102mm

Temperature: -35°C +70°C

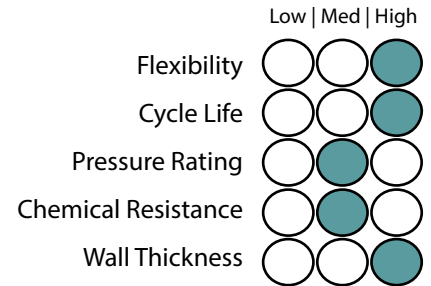

Construction

Use:

Built to AS2660 Class B. This heavy-duty, fire-resistant, anti-static suction hose is ideally suited for use in high fire risk industries.



Specifications

Part Number	Nominal Dia.		Working Pressure		Weight
	I.D (mm)	O.D (mm)	Bar	kPa	Kg/M
IH-RFS-25	25	36	10	1000	-
IH-RFS-51	51	65	10	1000	2.10
IH-RFS-76	76	91	10	1000	3.27
IH-RFS-102	102	118	10	1000	5.18

Applications



Rubber Hose - Chemical

FRAS Delivery

Part No.: IH-RFD

Colour: Black

Tube: FRAS black smooth synthetic rubber, oil mist resistant

Cover: FRAS black smooth synthetic rubber, abrasion and weather resistant

Reinforcement: Plies of high strength synthetic cord

Size Available: 12mm - 102mm

Temperature: -35°C +70°C

Low | Med | High

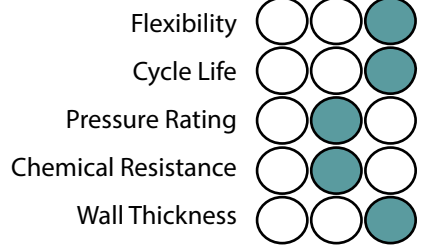

Construction

Use:

Built to AS2660 Class B, this heavy-duty, fire-resistant, anti-static air hose is ideally suited for use in the coal mining industry and other high fire risk areas.



Specifications

Part Number	Nominal Dia.		Working Pressure		Weight
	I.D (mm)	O.D (mm)	Bar	kPa	Kg/M
IH-RFD-12	12	23	20	2000	0.37
IH-RFD-19	19	31	20	2000	0.63
IH-RFD-25	25	37	20	2000	0.78
IH-RFD-32	32	46	20	2000	-
IH-RFD-38	38	52	20	2000	1.20
IH-RFD-51	51	67	20	2000	2.21
IH-RFD-64	64	81	20	2000	3.37
IH-RFD-76	76	92	20	2000	4.15
IH-RFD-102	102	122	20	2000	5.50

Applications



1 2 3 4 5 6 7 8 9

RUBBER & COMPOSITE HOSE

RUBBER & COMPOSITE HOSE

Rubber Hose - Mining

Hard-Wall Hoseflex® Mining Hose

Colour: Black
Tube: NR/BR blend Super Abrasion Resistant Rubber
Cover: Abrasion, UV and Ozone resistant rubber
Reinforcement: Spiral Synthetic fabric and wire helix
Size Available: DN50 to DN1200
Temperature: -30°C / + 70°C

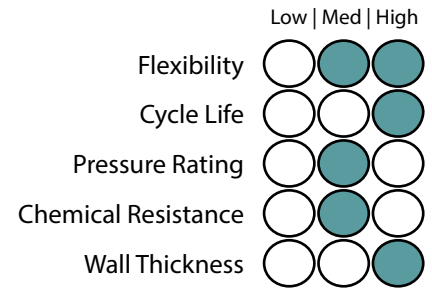

Construction

Use:
 Slurry and water transfer, dewatering and tailings pipelines as well as transfer of chemicals, hydrocarbons and acids.

End connections:
 Plain end, Flanged (fixed or swivel), Flanged full spigot (fixed or swivel), Double flanged, Grooved (roll or cut), Threaded, Butt weld, Custom



Notes

Bend Radius - Based on 700Kpa.
 Max Working Pressure - Determined by construction and fitting/flange design
 Lengths - Can be made up to 10 meters

Specifications

Hose Size			Standard Liner Thickness		Max Liner Thickness		Vacuum Rating	Standard Working Pressure		Max Working Pressure		Min Bend Radius	
DN	in	mm	mm	in	mm	in	%	kPa	PSI	kPa	PSI	mm	Dia
50	2	50.8	4.5	1/6	6	1/4	100	700	102	6000	870	410	8
80	3	76.2	4.5	1/6	6	1/4	100	700	102	6000	870	610	8
100	4	101.6	6	1/4	9	1/3	100	700	102	6000	870	810	8
125	5	127	6	1/4	9	1/3	100	700	102	6000	870	1020	8
150	6	152.4	6	1/4	9	1/3	100	700	102	6000	870	1220	8
200	8	203.2	6	1/4	9	1/3	100	700	102	5000	725	1630	8
250	10	254	6	1/4	12	1/2	100	700	102	5000	725	2540	10
300	12	304.8	6	1/4	12	1/2	100	700	102	5000	725	3050	10
350	14	355.6	9	1/3	15	3/5	100	700	102	4000	580	3560	10
400	16	406.4	9	1/3	15	3/5	100	700	102	3500	508	4060	10
450	18	457.2	9	1/3	18	5/7	100	700	102	3000	435	5490	12
500	20	508	9	1/3	18	5/7	100	700	102	3000	435	6100	12
550	22	558.8	9	1/3	21	5/6	100	700	102	3000	435	7820	14
600	24	610	12	1/2	21	5/6	100	700	102	2500	363	8540	14
650	26	660.4	12	1/2	21	5/6	100	700	102	2500	363	10570	16
700	28	700	12	1/2	24	1	100	700	102	2000	290	11200	16
750	30	750	12	1/2	24	1	100	700	102	2000	290	12000	16
800	32	800	15	3/5	24	1	100	700	102	1800	261	12800	16
900	36	900	15	3/5	24	1	100	700	102	1800	261	14400	16
1000	40	1000	15	3/5	27	1	100	700	102	1500	218	16000	16
1100	44	1100	15	3/5	27	1	100	700	102	1000	145	17600	16
1200	48	1200	15	3/5	27	1	100	700	102	1000	145	19200	16

RUBBER & COMPOSITE HOSE

Rubber Hose - Mining

Soft Wall Hoseflex® Mining Hose

Part No: IH-RWCS
Colour: Black
Tube: NR/BR blend Super Abrasion Resistant Rubber
Cover: Abrasion, UV and Ozone resistant rubber
Reinforcement: Synthetic fabric
Size Available: DN50 to DN1200
Temperature: -30°C / + 70°C

	Low	Med	High
Flexibility	<input type="radio"/>	<input checked="" type="radio"/>	<input type="radio"/>
Cycle Life	<input type="radio"/>	<input type="radio"/>	<input checked="" type="radio"/>
Pressure Rating	<input type="radio"/>	<input checked="" type="radio"/>	<input type="radio"/>
Chemical Resistance	<input type="radio"/>	<input checked="" type="radio"/>	<input type="radio"/>
Wall Thickness	<input type="radio"/>	<input type="radio"/>	<input checked="" type="radio"/>

Construction

Use:
 Slurry and water transfer, dewatering and tailings pipelines as well as transfer of chemicals, hydrocarbons and acids.

End connections:
 Plain end, Flanged (fixed or swivel), Flanged full spigot (fixed or swivel), Double flanged, Grooved (roll or cut), Threaded, Butt weld, Custom



Notes

Max Liner thickness is gauged by flange pattern
 Max Working Pressure - Determined by construction and fitting/flange design
 No Bend radius advised for non wire reinforced hose
 Lengths - Can be made up to 10 meters

Specifications

Hose Size			Standard Liner Thickness		Max Liner Thickness		Vacuum Rating	Standard Working Pressure		Max Working Pressure	
DN	in	mm	mm	in	mm	in	%	kPa	PSI	kPa	PSI
50	2	50.8	4.5	1/6	6	1/4	n/a	700	102	6000	870
80	3	76.2	4.5	1/6	6	1/4	n/a	700	102	6000	870
100	4	101.6	6	1/4	9	1/3	n/a	700	102	6000	870
125	5	127	6	1/4	9	1/3	n/a	700	102	6000	870
150	6	152.4	6	1/4	9	1/3	n/a	700	102	6000	870
200	8	203.2	6	1/4	9	1/3	n/a	700	102	5000	725
250	10	254	6	1/4	12	1/2	n/a	700	102	5000	725
300	12	304.8	6	1/4	12	1/2	n/a	700	102	5000	725
350	14	355.6	9	1/3	15	3/5	n/a	700	102	4000	580
400	16	406.4	9	1/3	15	3/5	n/a	700	102	3500	508
450	18	457.2	9	1/3	18	5/7	n/a	700	102	3000	435
500	20	508	9	1/3	18	5/7	n/a	700	102	3000	435
550	22	558.8	9	1/3	21	5/6	n/a	700	102	3000	435
600	24	610	12	1/2	21	5/6	n/a	700	102	2500	363
650	26	660.4	12	1/2	21	5/6	n/a	700	102	2500	363
700	28	700	12	1/2	24	1	n/a	700	102	2000	290
750	30	750	12	1/2	24	1	n/a	700	102	2000	290
800	32	800	15	3/5	24	1	n/a	700	102	1800	261
900	36	900	15	3/5	24	1	n/a	700	102	1800	261
1000	40	1000	15	3/5	27	1	n/a	700	102	1500	218
1100	44	1100	15	3/5	27	1	n/a	700	102	1000	145
1200	48	1200	15	3/5	27	1	n/a	700	102	1000	145

RUBBER & COMPOSITE HOSE

Rubber Hose - Mining

Ceramic Hoseflex® Mining Hose

Colour: Black
Tube: NR/BR blend Super Abrasion Resistant Rubber
Cover: Abrasion, UV and Ozone resistant rubber
Reinforcement: Spiral Synthetic fabric and wire helix
Size Available: DN50 to DN1200
Temperature: -30°C / + 70°C

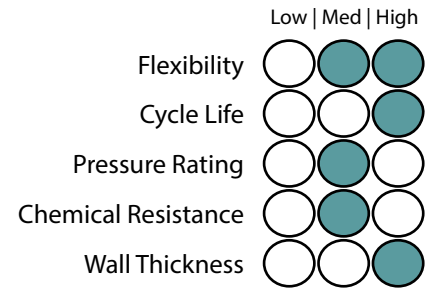

Construction

Use:
 Ceramic mining hose is designed to be extremely resistant to abrasion even in high material flows and speeds, preventing material build-up. The ideal solution for high wearing mining and aggregates applications.

Used in slurry and water transfer, dewatering and tailings pipelines as well as transfer of chemicals, hydrocarbons and acids.

Lengths - Can be made up to 10 meters

End connections: Plain end, Flanged (fixed or swivel), Flanged full spigot (fixed or swivel), Double flanged, Grooved (roll or cut), Threaded, Butt weld, Custom



Specifications

Hose Size			Standard Linear Thickness		Max Liner Thickness		Vacuum Rating	Standard Working Pressure		Max Working Pressure		Min Bend Radius	
DN	in	mm	mm	in	mm	in	%	kPa	PSI	kPa	PSI	mm	Dia
50	2	50.8	4.5	1/6	6	1/4	100	700	102	6000	870	410	8
80	3	76.2	4.5	1/6	6	1/4	100	700	102	6000	870	610	8
100	4	101.6	6	1/4	9	1/3	100	700	102	6000	870	810	8
125	5	127	6	1/4	9	1/3	100	700	102	6000	870	1020	8
150	6	152.4	6	1/4	9	1/3	100	700	102	6000	870	1220	8
200	8	203.2	6	1/4	9	1/3	100	700	102	5000	725	1630	8
250	10	254	6	1/4	12	1/2	100	700	102	5000	725	2540	10
300	12	304.8	6	1/4	12	1/2	100	700	102	5000	725	3050	10
350	14	355.6	9	1/3	15	3/5	100	700	102	4000	580	3560	10
400	16	406.4	9	1/3	15	3/5	100	700	102	3500	508	4060	10
450	18	457.2	9	1/3	18	5/7	100	700	102	3000	435	5490	12
500	20	508	9	1/3	18	5/7	100	700	102	3000	435	6100	12
550	22	558.8	9	1/3	21	5/6	100	700	102	3000	435	7820	14
600	24	610	12	1/2	21	5/6	100	700	102	2500	363	8540	14
650	26	660.4	12	1/2	21	5/6	100	700	102	2500	363	10570	16
700	28	700	12	1/2	24	1	100	700	102	2000	290	11200	16
750	30	750	12	1/2	24	1	100	700	102	2000	290	12000	16
800	32	800	15	3/5	24	1	100	700	102	1800	261	12800	16
900	36	900	15	3/5	24	1	100	700	102	1800	261	14400	16
1000	40	1000	15	3/5	27	1	100	700	102	1500	218	16000	16
1100	44	1100	15	3/5	27	1	100	700	102	1000	145	17600	16
1200	48	1200	15	3/5	27	1	100	700	102	1000	145	19200	16

RUBBER & COMPOSITE HOSE

Rubber Hose - Mining

Pre-Formed Bend Hoseflex® Mining Hose

Colour: Black
Tube: NR/BR blend Super Abrasion Resistant Rubber
Cover: Abrasion, UV and Ozone resistant rubber
Reinforcement: Spiral Synthetic fabric and wire helix
Size Available: DN50 to DN1200
Temperature: -30°C / + 70°C

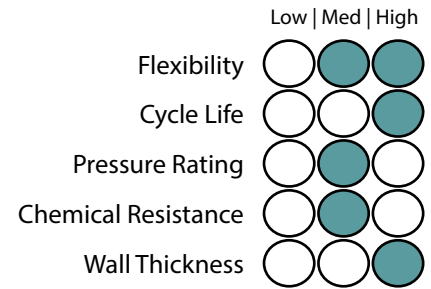

Construction

Use: Designed for suction and discharge duties. Used for tight bend radius allowing movement and misalignment. Applications include slurry and water transfer, dewatering and tailings pipelines as well as transfer of chemicals, hydrocarbons and acids.

End connections: Plain end, Flanged (fixed or swivel), Flanged full spigot (fixed or swivel), Double flanged, Grooved (roll or cut), Threaded, Butt weld, Custom



Notes

The design is based on a 90 Degree Bend
 The Bends are built on the radius, straights ends can be added in design state.

Specifications

Hose Size		Standard Liner Thickness		Max Liner Thickness		Vacuum Rating	Standard Working Pressure		Max Working Pressure		Standard Centreline Radius		
in	mm	mm	in	mm	in	%	kPa	PSI	kPa	PSI	1.5D mm	3D mm	5D mm
2	50.8	4.5	1/6	6	1/4	100	700	102	2500	363	60	120	199
3	76.2	4.5	1/6	6	1/4	100	700	102	2500	363	90	179	299
4	101.6	6	1/4	9	3/8	100	700	102	2500	363	120	239	399
5	127	6	1/4	9	3/8	100	700	102	2500	363	150	299	498
6	152.4	6	1/4	9	3/8	100	700	102	2500	363	179	359	598
8	203.2	6	1/4	9	3/8	100	700	102	2500	363	239	479	798
10	254	6	1/4	12	1/2	100	700	102	2500	363	299	598	997
12	304.8	6	1/4	12	1/2	100	700	102	2500	363	359	718	1196
14	355.6	9	3/8	15	3/5	100	700	102	2500	363	419	837	1396
16	406.4	9	3/8	15	3/5	100	700	102	2500	363	479	957	1595
18	457.2	9	3/8	18	5/7	100	700	102	2500	363	538	1077	1795
20	508	9	3/8	18	5/7	100	700	102	2500	363	598	1196	1994
22	558.8	9	3/8	21	5/6	100	700	102	2500	363	658	1316	2193
24	610	12	1/2	21	5/6	100	350	51	2500	363	718	1437	2394
26	660.4	12	1/2	21	5/6	100	350	51	2000	290	778	1555	2592
28	700	12	1/2	24	1	100	350	51	2000	290	824	1649	2748
30	750	12	1/2	24	1	100	350	51	2000	290	883	1766	2944
32	800	15	3/5	24	1	100	350	51	1500	218	942	1884	3140
36	900	15	3/5	24	1	100	350	51	1000	145	1060	2120	3533
40	1000	15	3/5	27	1	100	350	51	1000	145	1178	2355	3925
44	1100	15	3/5	27	1	100	350	51	1000	145	1295	2591	4318
48	1200	15	3/5	27	1	100	350	51	1000	145	1413	2826	4710

RUBBER & COMPOSITE HOSE

Rubber Hose - Mining

Pre-formed Bend Hoseflex® Ceramic Hose

Colour: Black
Tube: NR/BR blend Super Abrasion Resistant Rubber
Cover: Abrasion, UV and Ozone resistant rubber
Reinforcement: Spiral Synthetic fabric and wire helix
Size Available: DN80 to DN1200
Temperature: -30°C / + 70°C

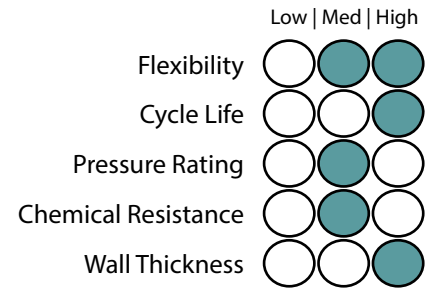

Construction

Use: Designed for suction and discharge duties. Used for tight bend radius allowing movement and misalignment. Applications include slurry and water transfer, dewatering and tailings pipelines as well as transfer of chemicals, hydrocarbons and acids. Ceramic preformed bend mining hose is designed to be extremely resistant to abrasion even in high material flows and speeds, preventing material build-up. The ideal solution for high wearing mining and aggregates applications.



End connections: Plain end, Flanged (fixed or swivel), Flanged full spigot (fixed or swivel), Double flanged, Grooved (roll or cut), Threaded, Butt weld, Custom

Notes

The design is based on a 90 Degree Bend
 The Bends are built on the radius, straights ends can be added in design state

Specifications

Hose Size			Standard Liner Thickness		Max Liner Thickness		Vacuum Rating	Standard Working Pressure		Max Working Pressure		Standard Centreline Radius			
DN	in	mm	mm	in	mm	in	%	kPa	PSI	kPa	PSI	1D mm	1.5D mm	3D mm	5D mm
80	3	76.2	4.5	1/6	6	1/4	100	700	102	2500	363	n/a	90	179	299
100	4	101.6	6	1/4	9	1/3	100	700	102	2500	363	n/a	120	239	399
125	5	127	6	1/4	9	1/3	100	700	102	2500	363	n/a	150	299	498
150	6	152.4	6	1/4	9	1/3	100	700	102	2500	363	n/a	179	359	598
200	8	203.2	6	1/4	9	1/3	100	700	102	2500	363	n/a	239	479	798
250	10	254	6	1/4	12	1/2	100	700	102	2500	363	n/a	299	598	997
300	12	304.8	6	1/4	12	1/2	100	700	102	2500	363	n/a	359	718	1196
350	14	355.6	9	1/3	15	3/5	100	700	102	2500	363	n/a	419	837	1396
400	16	406.4	9	1/3	15	3/5	100	700	102	2500	363	n/a	479	957	1595
450	18	457.2	9	1/3	18	5/7	100	700	102	2500	363	n/a	538	1077	1795
500	20	508	9	1/3	18	5/7	100	700	102	2500	363	n/a	598	1196	1994
550	22	558.8	9	1/3	21	5/6	100	700	102	2500	363	n/a	658	1316	2193
600	24	610	12	1/2	21	5/6	100	350	51	2500	363	n/a	718	1437	2394
650	26	660.4	12	1/2	21	5/6	100	350	51	2000	290	n/a	778	1555	2592
700	28	700	12	1/2	24	1	100	350	51	2000	290	n/a	824	1649	2748
750	30	750	12	1/2	24	1	100	350	51	2000	290	n/a	883	1766	2944
800	32	800	15	3/5	24	1	100	350	51	1500	218	n/a	942	1884	3140
900	36	900	15	3/5	24	1	100	350	51	1000	145	n/a	1060	2120	3533
1000	40	1000	15	3/5	27	1	100	350	51	1000	145	n/a	1178	2355	3925
1100	44	1100	15	3/5	27	1	100	350	51	1000	145	n/a	1295	2591	4318
1200	48	1200	15	3/5	27	1	100	350	51	1000	145	n/a	1413	2826	4710

RUBBER & COMPOSITE HOSE

Rubber Hose - Mining

Reducer Hoseflex® Mining Hose

Colour: Black
Tube: NR/BR blend Super Abrasion Resistant Rubber
Cover: Abrasion, UV and Ozone resistant rubber
Reinforcement: Spiral Synthetic fabric and wire helix
Size Available: DN50 to DN1200
Temperature: -30°C / + 70°C

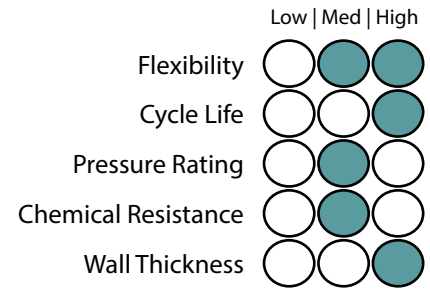

Construction

Use: Used in connecting varying sizes of pipework. Prodomentialy used in pump suction and discharge. Applications include slurry or water transfer in mineral processing plants, tailings pipelines and dewatering.

End connections: Plain end, Flanged (fixed or swivel), Flanged full spigot (fixed or swivel), Double flanged, Grooved (roll or cut), Threaded, Butt weld, Custom



Notes

We have left off lengths, there is nothing standard we have ever come across
 Rubber gauges, these are often much heavier in gauge across the wear points (reducing area)

Specifications

Hose Size			Standard Liner Thickness		Max Liner Thickness		Vacuum Rating	Standard Working Pressure		Max Working Pressure	
DN	in	mm	mm	in	mm	in	%	kPa	PSI	kPa	PSI
50	2	50.8	4.5	1/6	6	1/4	100	700	102	3000	435
80	3	76.2	4.5	1/6	6	1/4	100	700	102	3000	435
100	4	101.6	6	1/4	9	1/3	100	700	102	3000	435
125	5	127	6	1/4	9	1/3	100	700	102	3000	435
150	6	152.4	6	1/4	9	1/3	100	700	102	3000	435
200	8	203.2	6	1/4	9	1/3	100	700	102	2500	363
250	10	254	6	1/4	12	1/2	100	700	102	2500	363
300	12	304.8	6	1/4	12	1/2	100	700	102	2500	363
350	14	355.6	9	1/3	15	3/5	100	700	102	2000	290
400	16	406.4	9	1/3	15	3/5	100	700	102	1750	254
450	18	457.2	9	1/3	18	5/7	100	700	102	1500	218
500	20	508	9	1/3	18	5/7	100	700	102	1500	218
550	22	558.8	9	1/3	21	5/6	100	700	102	1500	218
600	24	610	12	1/2	21	5/6	100	700	102	1250	181
650	26	660.4	12	1/2	21	5/6	100	700	102	1250	181
700	28	700	12	1/2	24	1	100	700	102	1000	145
750	30	750	12	1/2	24	1	100	700	102	1000	145
800	32	800	15	3/5	24	1	100	700	102	900	131
900	36	900	15	3/5	24	1	100	700	102	900	131
1000	40	1000	15	3/5	27	1	100	700	102	750	109
1100	44	1100	15	3/5	27	1	100	700	102	500	73
1200	48	1200	15	3/5	27	1	100	700	102	500	73

1 2 3 4 5 6 7 8 9

RUBBER & COMPOSITE HOSE

Rubber Hose - Mining

Reducer Ceramic Hoseflex® Mining Hose

Colour: Black
Tube: NR/BR blend Super Abrasion Resistant Rubber
Cover: Abrasion, UV and Ozone resistant rubber
Reinforcement: Spiral Synthetic fabric and wire helix
Size Available: DN80 to DN1200
Temperature: -30°C / + 70°C

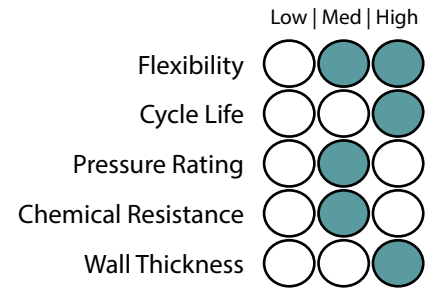

Construction

Use: Used in connecting varying sizes of pipework. Prodomentially used in pump suction and discharge. Applications include slurry or water transfer in mineral processing plants, tailings pipelines and dewatering.

Ceramic reducer mining hose is designed to be extremely resistant to abrasion even in high material flows and speeds, preventing material build-up. The ideal solution for high wearing mining and aggregates applications.

End connections: Plain end, Flanged (fixed or swivel), Flanged full spigot (fixed or swivel), Double flanged, Grooved (roll or cut), Threaded, Butt weld, Custom



Notes

We have left off lengths, there is nothing standard we have ever come across Rubber gauges, these are often much heavier in gauge across the wear points (reducing area)

Specifications

Hose Size			Standard Liner Thickness		Max Liner Thickness		Vacuum Rating	Standard Working Pressure		Max Working Pressure		Standard Centreline Radius		
DN	in	mm	mm	in	mm	in	%	kPa	PSI	kPa	PSI	1.5D mm	3D mm	5D mm
50	2	50.8	4.5	1/6	6	1/4	100	700	102	2500	363	60	120	199
80	3	76.2	4.5	1/6	6	1/4	100	700	102	2500	363	90	179	299
100	4	101.6	6	1/4	9	1/3	100	700	102	2500	363	120	239	399
125	5	127	6	1/4	9	1/3	100	700	102	2500	363	150	299	498
150	6	152.4	6	1/4	9	1/3	100	700	102	2500	363	179	359	598
200	8	203.2	6	1/4	9	1/3	100	700	102	2500	363	239	479	798
250	10	254	6	1/4	12	1/2	100	700	102	2500	363	299	598	997
300	12	304.8	6	1/4	12	1/2	100	700	102	2500	363	359	718	1196
350	14	355.6	9	1/3	15	3/5	100	700	102	2500	363	419	837	1396
400	16	406.4	9	1/3	15	3/5	100	700	102	2500	363	479	957	1595
450	18	457.2	9	1/3	18	5/7	100	700	102	2500	363	538	1077	1795
500	20	508	9	1/3	18	5/7	100	700	102	2500	363	598	1196	1994
550	22	558.8	9	1/3	21	5/6	100	700	102	2500	363	658	1316	2193
600	24	610	12	1/2	21	5/6	100	350	51	2500	363	718	1437	2394
650	26	660.4	12	1/2	21	5/6	100	350	51	2000	290	778	1555	2592
700	28	700	12	1/2	24	1	100	350	51	2000	290	824	1649	2748
750	30	750	12	1/2	24	1	100	350	51	2000	290	883	1766	2944
800	32	800	15	3/5	24	1	100	350	51	1500	218	942	1884	3140
900	36	900	15	3/5	24	1	100	350	51	1000	145	1060	2120	3533
1000	40	1000	15	3/5	27	1	100	350	51	1000	145	1178	2355	3925
1100	44	1100	15	3/5	27	1	100	350	51	1000	145	1295	2591	4318
1200	48	1200	15	3/5	27	1	100	350	51	1000	145	1413	2826	4710

RUBBER & COMPOSITE HOSE

Rubber Hose - Mining

Y Piece Hoseflex® Mining Hose

Colour: Black
Tube: NR/BR blend Super Abrasion Resistant Rubber
Cover: Abrasion, UV and Ozone resistant rubber
Reinforcement: Spiral Synthetic fabric and wire helix
Size Available: DN50 to DN1200
Temperature: -30°C / + 70°C

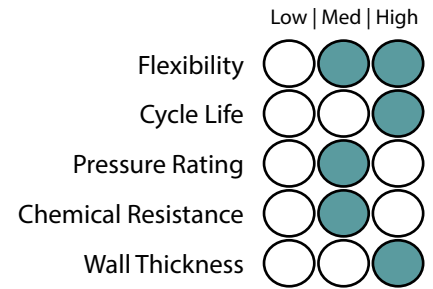

Construction

Use:

Y piece mining hose used in connecting one pipeline into two pipelines or vice versa. Fully customised to suit your existing pipe work. Suitable for both suction and discharge duties. Applications include slurry or water transfer in mineral processing plants, tailings pipelines and dewatering.

End connections: Plain end, Flanged (fixed or swivel), Flanged full spigot (fixed or swivel), Double flanged, Grooved (roll or cut), Threaded, Butt weld, Custom



Specifications

Hose Size			Standard Liner Thickness		Max Liner Thickness		Vacuum Rating	Standard Working Pressure		Max Working Pressure	
DN	in	mm	mm	in	mm	in	%	kPa	PSI	kPa	PSI
50	2	50.8	4.5	1/6	6	1/4	100	700	102	3000	435
80	3	76.2	4.5	1/6	6	1/4	100	700	102	3000	435
100	4	101.6	6	1/4	9	1/3	100	700	102	3000	435
125	5	127	6	1/4	9	1/3	100	700	102	3000	435
150	6	152.4	6	1/4	9	1/3	100	700	102	3000	435
200	8	203.2	6	1/4	9	1/3	100	700	102	2500	363
250	10	254	6	1/4	12	1/2	100	700	102	2500	363
300	12	304.8	6	1/4	12	1/2	100	700	102	2500	363
350	14	355.6	9	1/3	15	3/5	100	700	102	2000	290
400	16	406.4	9	1/3	15	3/5	100	700	102	1750	254
450	18	457.2	9	1/3	18	5/7	100	700	102	1500	218
500	20	508	9	1/3	18	5/7	100	700	102	1500	218
550	22	558.8	9	1/3	21	5/6	100	700	102	1500	218
600	24	610	12	1/2	21	5/6	100	700	102	1250	181
650	26	660.4	12	1/2	21	5/6	100	700	102	1250	181
700	28	700	12	1/2	24	1	100	700	102	1000	145
750	30	750	12	1/2	24	1	100	700	102	1000	145
800	32	800	15	3/5	24	1	100	700	102	900	131
900	36	900	15	3/5	24	1	100	700	102	900	131
1000	40	1000	15	3/5	27	1	100	700	102	750	109
1100	44	1100	15	3/5	27	1	100	700	102	500	73
1200	48	1200	15	3/5	27	1	100	700	102	500	73

Rubber Hose - Mining

Y Piece Hard Wall Hoseflex® Mining Hose

Part No: IH-RWCS

Colour: Black

Tube: NR/BR blend Super Abrasion Resistant Rubber

Cover: Abrasion, UV and Ozone resistant rubber

Reinforcement: Spiral Synthetic fabric and wire helix

Size Available: DN80 to DN1200

Temperature: -30°C / + 70°C

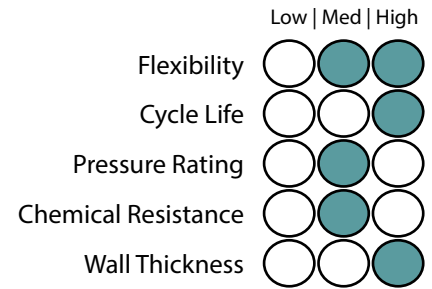

Construction

Use:

Y piece mining hose used in connecting one pipeline into two pipelines or vice versa. Fully customised to suit your existing pipe work. Suitable for both suction and discharge duties. Applications include slurry or water transfer in mineral processing plants, tailings pipelines and dewatering.

Ceramic Y piece mining hose is designed to be extremely resistant to abrasion even in high material flows and speeds, preventing material build-up. The ideal solution for high wearing mining and aggregates applications.

End connections:

Plain end, Flanged (fixed or swivel), Flanged full spigot (fixed or swivel), Double flanged, Grooved (roll or cut), Threaded, Butt weld, Custom



Specifications

Hose Size			Standard Liner Thickness		Max Liner		Vacuum Rating	Standard Working Pressure		Max Working Pressure	
DN	in	mm	mm	in	mm	in	%	kPa	PSI	kPa	PSI
80	3	76.2	4.5	1/6	6	1/4	100	700	102	3000	435
100	4	101.6	6	1/4	9	1/3	100	700	102	3000	435
125	5	127	6	1/4	9	1/3	100	700	102	3000	435
150	6	152.4	6	1/4	9	1/3	100	700	102	3000	435
200	8	203.2	6	1/4	9	1/3	100	700	102	2500	363
250	10	254	6	1/4	12	1/2	100	700	102	2500	363
300	12	304.8	6	1/4	12	1/2	100	700	102	2500	363
350	14	355.6	9	1/3	15	3/5	100	700	102	2000	290
400	16	406.4	9	1/3	15	3/5	100	700	102	1750	254
450	18	457.2	9	1/3	18	5/7	100	700	102	1500	218
500	20	508	9	1/3	18	5/7	100	700	102	1500	218
550	22	558.8	9	1/3	21	5/6	100	700	102	1500	218
600	24	610	12	1/2	21	5/6	100	700	102	1250	181
650	26	660.4	12	1/2	21	5/6	100	700	102	1250	181
700	28	700	12	1/2	24	1	100	700	102	1000	145
750	30	750	12	1/2	24	1	100	700	102	1000	145
800	32	800	15	3/5	24	1	100	700	102	900	131
900	36	900	15	3/5	24	1	100	700	102	900	131
1000	40	1000	15	3/5	27	1	100	700	102	750	109
1100	44	1100	15	3/5	27	1	100	700	102	500	73
1200	48	1200	15	3/5	27	1	100	700	102	500	73

RUBBER & COMPOSITE HOSE

Rubber Hose - Mining

Hard Wall Hoseflex® Mining Hose

Colour: Black

Tube: NR/BR blend Super Abrasion Resistant Rubber

Cover: Abrasion, UV and Ozone resistant rubber

Reinforcement: Spiral Synthetic fabric and wire helix.

Size Available: DN50 to DN1200

Temperature: -30°C / + 70°C

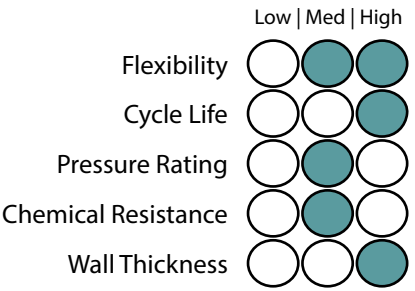

Construction

Use:

A hard wall hose used in applications which require a tight bend radius. Suitable for both suction and discharge duty.

Lengths - Can be made up to 10 meters

End connections:

Plain end, Flanged (fixed or swivel), Flanged full spigot (fixed or swivel), Double flanged, Grooved (roll or cut), Threaded, Butt weld, Custom



Specifications

Hose Size			Standard Liner Thickness		Max Liner Thickness		Vacuum Rating	Standard Working Pressure		Max Working Pressure		Min Bend Radius	
DN	in	mm	mm	in	mm	in	%	kPa	PSI	kPa	PSI	mm	Dia
50	2	50.8	4.5	1/6	6	1/4	100	700	102	2000	290	200	4.00
80	3	76.2	4.5	1/6	6	1/4	100	700	102	2000	290	300	4.00
100	4	101.6	6	1/4	9	1/3	100	700	102	2000	290	410	4.00
125	5	127	6	1/4	9	1/3	100	700	102	2000	290	510	4.00
150	6	152.4	6	1/4	9	1/3	100	700	102	2000	290	610	4.00
200	8	203.2	6	1/4	9	1/3	100	700	102	2000	290	1220	6.00
250	10	254	6	1/4	12	1/2	100	700	102	2000	290	1520	6.00
300	12	304.8	6	1/4	12	1/2	100	700	102	2000	290	1830	6.00
350	14	355.6	9	1/3	15	3/5	100	700	102	1750	254	2840	8.00
400	16	406.4	9	1/3	15	3/5	100	700	102	1750	254	3250	8.00
450	18	457.2	9	1/3	18	5/7	100	700	102	1750	254	3660	8.00
500	20	508	9	1/3	18	5/7	100	700	102	1750	254	5080	10.00
550	22	558.8	9	1/3	21	5/6	100	700	102	1750	254	5590	10.00
600	24	610	12	1/2	21	5/6	100	700	102	1500	218	7320	12.00
650	26	660.4	12	1/2	21	5/6	100	700	102	1500	218	7920	12.00
700	28	700	12	1/2	24	1	100	700	102	1500	218	11200	16.00
750	30	750	12	1/2	24	1	100	700	102	1500	218	12000	16.00
800	32	800	15	3/5	24	1	100	350	51	1500	218	12.800	16.00
900	36	900	15	3/5	24	1	100	350	51	1800	261	14400	16.00
1000	40	1000	15	3/5	27	1	100	350	51	1000	145	16000	16.00
1100	44	1100	15	3/5	27	1	100	350	51	1000	145	17600	16.00
1200	48	1200	15	3/5	27	1	100	350	51	1000	145	19200	16.00

RUBBER & COMPOSITE HOSE

1 2 3 4 5 6 7 8 9

RUBBER & COMPOSITE HOSE

Rubber Hose - Mining

Muff Coupling Hoseflex® Mining Hose

Colour: Black
Tube: NR/BR blend Super Abrasion Resistant Rubber
Cover: Abrasion, UV and Ozone resistant rubber
Reinforcement: Spiral Synthetic fabric and wire helix
Size Available: DN50 to DN350
Temperature: -30°C / + 70°C

	Low Med High
Flexibility	<input type="radio"/> <input checked="" type="radio"/> <input type="radio"/>
Cycle Life	<input type="radio"/> <input type="radio"/> <input checked="" type="radio"/>
Pressure Rating	<input type="radio"/> <input checked="" type="radio"/> <input type="radio"/>
Chemical Resistance	<input type="radio"/> <input checked="" type="radio"/> <input type="radio"/>
Wall Thickness	<input type="radio"/> <input type="radio"/> <input checked="" type="radio"/>

Construction

Use:
 Suitable for suction and discharge duty. Used in the transfer of slurry and water transfer, dewatering and tailings pipelines.

Lengths DN 50-100: Can be made up to 40 meters
 Lengths DN 125-150: Can be made up to 20 meters
 Lengths DN 250-350: Can be made up to 12 meters



Specifications

Hose Size			Standard Liner Thickness		Vacuum Rating	Standard Working Pressure		Min Bend Radius		
DN	in	mm	mm	in	%	kPa	PSI	M	FT	X Dia
50	2	50.8	6	1/4	100	700	100	0.30	0.96	6
80	3	76.2	6	1/4	100	700	100	0.61	1.91	8
100	4	101.6	6	1/4	100	700	100	0.81	2.55	8
125	5	127	6	1/4	100	700	100	1.02	3.19	8
150	6	152.4	6	1/4	100	700	100	1.22	3.83	8
200	8	203.2	6	1/4	100	700	100	1.63	5.1	8
250	10	254	9	1/3	100	700	100	2.54	7.98	10
300	12	304.8	9	1/3	100	700	100	3.66	11.48	12
350	14	355.6	12	1/2	100	700	100	4.98	15.63	14

Applications



Rubber Hose - Mining

Sand & Shot Blast Suction/Discharge Hose

Colour: Black

Tube: NR/BR blend Super Abrasion Resistant (S A R) Rubber

Cover: NR/BR blend Super Abrasion Resistant (S A R) Rubber

Reinforcement: Spiral Synthetic Fabric

Size Available: 1/2" - 3"

Temperature: -30°C +70°C

	Low	Med	High
Flexibility	○	●	○
Cycle Life	○	○	●
Pressure Rating	○	○	●
Chemical Resistance	○	●	○
Wall Thickness	○	●	○

Construction

Use:

Used for suction or discharge of water and light slurry



Specifications

	Size		Max. Working Pressure		Weight
	inch	O.D (mm)	PSI	kPa	Kg/m
IH-SSB-12	1/2"	33	150	1034	0.98
IH-SB-20	3/4"	40	150	1034	1.23
IH-SSB-25	1"	48	150	1034	1.72
IH-SSB-32	1 1/4"	55	150	1034	2.06
IH-SSB-28	1 1/2"	61	150	1034	2.29
IH-SSB-50	2"	76	150	1034	3.14
IH-SSB-80	3"	103	150	1034	4.62

End Connections

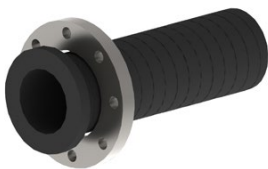

Beaded (Rotating) Flanges

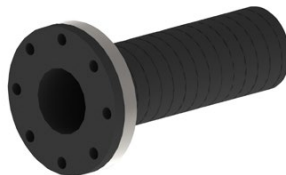

Fixed Flanges



Double Flanges



Spigot Flanges

Applications



Rubber Hose - Mining

Contractors Suction

Part No: IH-RWCS

Colour: Black

Tube: Black smooth synthetic rubber.

Cover: Black corrugated synthetic rubber, abrasion and weather resistant.

Reinforcement: Plies of high strength synthetic cord incorporating a steel wire helix.

Size Available: 76mm - 305mm

Temperature: -35°C +70°C

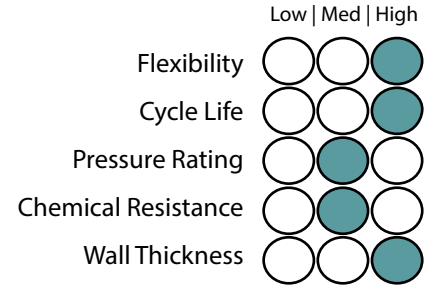

Construction

Use:

Highly flexible corrugated rubber hose suitable for the transfer of water in negative pressure applications. Lengths incorporate cuffed ends for ease of inserting hose fitting.



Specifications

Part Number	Nominal Dia.		Working Pressure		Weight
	I.D (mm)	O.D (mm)	Bar	kPa	Kg/M
IH-RWCS-76	76	95	10	1000	3.52
IH-RWCS-102	102	123	10	1000	4.59
IH-RWCS-152	152	176	10	1000	7.86
IH-RWCS-204	204	240	10	1000	11.70
IH-RWCS-254	254	290	10	1000	16.70
IH-RWCS-305	305	-	10	1000	-

Applications



Rubber Hose - Industrial

Rubber Jacketed Hose

A jacketed assembly consists of a "hose within a hose." An inner or primary media conveying hose is enclosed or jacketed by a larger diameter hose. The hoses are joined at each end by specially designed fittings so that there is no media pathway between the two hoses.

Jacketed assemblies are often specified when the primary media must be kept at either an elevated or cryogenic temperature. Steam is often circulated through the jacket hose to keep a viscous material in the inner hose hot and easily conveyed. A vacuum can also be pulled on the jacket hose to insulate cryogenic liquids being conveyed in the inner hose.

The media typically is steam, hot oil or hot water to raise the temperature of the fluid moved in the internal hose. Also cold products such as liquid helium or nitrogen can be used to lower the temperature of the fluid with-in the internal hose.

The specialist hose design can also be used to contain hazardous and chemical mediums in the event of a rupture. The outer hose will capture any medium that leaks from the inner hose preventing any safety or environmental issues. Sensors can be installed on the ports of the outer hoses to analyse any changes in pressure or gas detection.

Following Applications:

- Rail car and tank truck loading/unloading
- Marine Transfer
- Flexible connections to vibrating equipment
- To relieve pump housing stresses
- Hazardous material piping system using an alarmed vacuum jacket
- Safety barrier for toxic processes
- Leak detection systems
- Liquefied food transfer systems

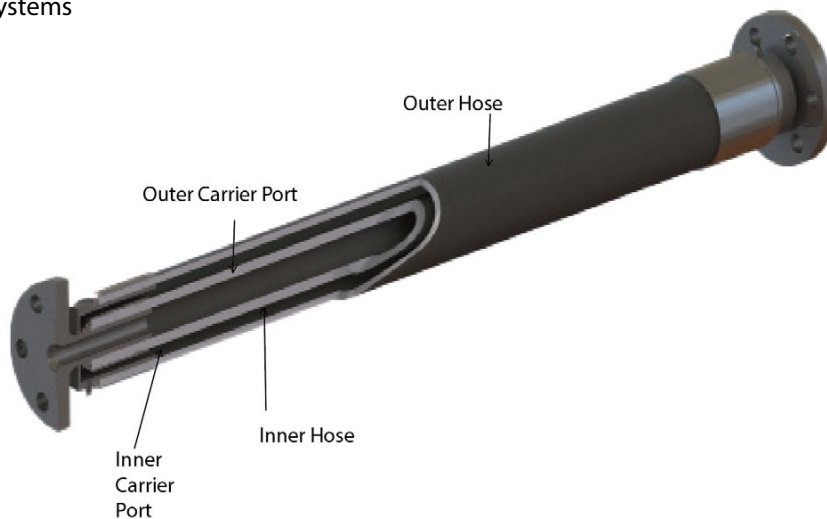

Inner hose nb size	25mm	32mm	38mm	50mm	65mm	75mm	100mm	125mm	150mm
Outer hose nb size	50mm	65mm	65mm	75mm	100mm	100mm	150mm	150mm	200mm
Inner hose max pressure (kPa)	1000	1000	1000	1000	1000	1000	1000	1000	1000

Rubber Hose - Offshore

Introduction:

Pacific Hoseflex has the capabilities to supply the complete marine oil and gas fluid transfer range. The product range consists of:

Petrol/Oil Bunkering

Size : 102mm to 302mm
Material : NBR Rubber
Temperature: -30°C +100°C



Suction/Delivery Abrasive material

Size : 76m to 127mm
Material : SR/SBR rubber
Temperature: -25°C +70°C

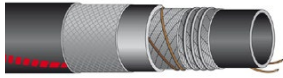

Dry Disconnect Coupling Hose Unit

Size : 25mm to 150mm
Material : 316 Stainless Steel / Aluminium



Dry Disconnect Tank Unit

Size : 25mm to 150mm
Material : 316/304 Stainless Steel



Swivel Joint

Size : 12mm to 400mm
Material : 316 Stainless Steel, Carbon steel, Aluminium



Flange Camlock Coupling

Size : 100mm to 600mm
Material : Carbon Steel / 316 Stainless steel



Composite LNG/LPG

Size : 20mm to 300mm
Material : Polypropilene films
316/304 Stainless Steel wire

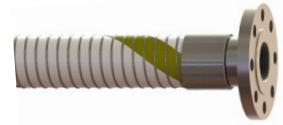

Mud Bunkering

Size : 76mm to 254mm
Material : NBR/PVC Rubber
Temperature: -40°C +100°C



Suction/Discharge Potable water

Size : 51mm to 102mm
Material : IIR rubber (food quality)
Temperature: -40°C +100°C

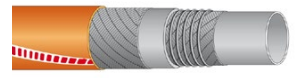

Marine Breakaway Coupling

Size : 50mm to 150mm
Material : 316 Stainless Steel



Industrial Breakaway Coupling

Size : 12mm - 300mm
Material : 316 Stainless Steel



Full bore Marine Breakaway Coupling

Size : 50mm to 200mm
Material : 316 Stainless Steel



Emergency Release Coupling

Size : 50mm to 300mm
Material : 316 Stainless Steel

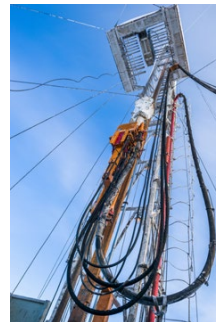
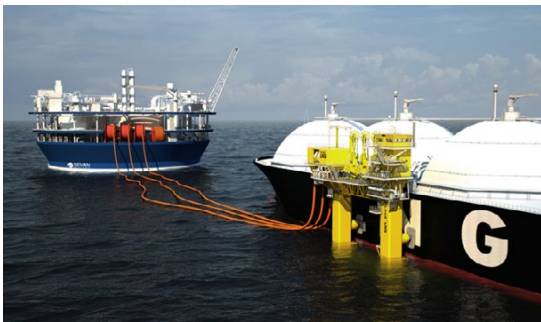

Rubber Hose - Water - Utility

AIRWATER SW/25

Part No.: IH-RAW-20

Colour: Green

Tube: Black, smooth, SBR rubber compound

Cover: Green, smooth cloth impression, SBR rubber compound, oil, grease, sea water and weather resistant

Reinforcement: High strength synthetic plies

Size Available: Various

Temperature: -30°C +80°C

	Low Med High
Flexibility	<input type="radio"/> <input type="radio"/> <input type="radio"/>
Cycle Life	<input type="radio"/> <input type="radio"/> <input type="radio"/>
Pressure Rating	<input type="radio"/> <input type="radio"/> <input type="radio"/>
Chemical Resistance	<input type="radio"/> <input type="radio"/> <input type="radio"/>
Wall Thickness	<input type="radio"/> <input type="radio"/> <input type="radio"/>

Construction

Use:

Green air and water delivery hoses, for docks & oil rigs services

Standards

ISO 1403

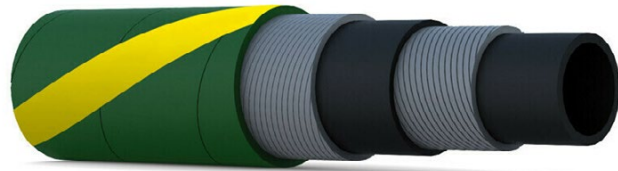

Specifications

Part Number	Size	Internal Diameter	Outside Diameter	Max. Working Pressure		Min. Burst Pressure	
	inch	mm	mm	bar	PSI	bar	PSI
IH-RAW-20-12	1/2"	13	23	20	300	80	1200
IH-RAW-20-20	3/4"	30	30	20	300	80	1200
IH-RAW-20-25	1"	37	37	20	300	80	1200
IH-RAW-20-32	1 1/4"	44	44	20	300	80	1200
IH-RAW-20-38	1 1/2"	52	52	20	300	80	1200
IH-RAW-20-50	2"	64	64	20	300	80	1200
IH-RAW-20-75	3"	96	96	20	300	80	1200
IH-RAW-20-100	4"	124	124	20	300	80	1200

Applications



Rubber Hose - Pneumatic Hose - Utility

AIRWATER SW/25

Part No.: IH-RAW-25

Colour: Blue

Tube: Black, smooth, SBR rubber compound

Cover: Blue, smooth cloth impression, SBR rubber compound, oil, grease, sea water and weather resistant

Reinforcement: High strength synthetic plies

Size Available: 12mm, 20mm and 25mm

Temperature: -30°C +80°C

Low | Med | High

Flexibility

Cycle Life

Pressure Rating

Chemical Resistance

Wall Thickness

Construction

Use:

Blue air and water delivery hoses, for docks & oil rigs services

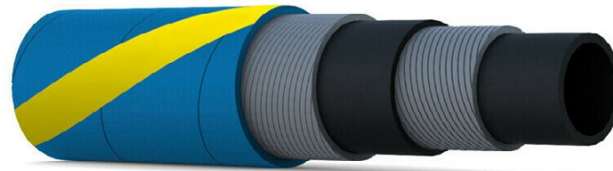

Standards

AS 2554 or ISO 5774

Specifications

Part Number	Size	Internal Diameter	Outside Diameter	Max. Working Pressure		Min. Burst Pressure	
	inch	mm	mm	bar	PSI	bar	PSI
IH-RAW-25-12	1/2"	13	23	25	362	80	1200
IH-RAW-25-20	3/4"	19	30	25	362	80	1200
IH-RAW-25-25	1"	25	37	25	362	80	1200
IH-RAW-25-32	1 1/4"	32	44	25	362	80	1200
IH-RAW-25-38	1 1/2"	38	52	25	362	80	1200
IH-RAW-25-50	2"	51	64	25	362	80	1200
IH-RAW-25-75	3"	76	96	25	362	80	1200
IH-RAW-25-100	4"	102	124	25	362	80	1200

Applications



Rubber Hose - Offshore

Suction/Delivery Abrasive hose

Part No.: IH-AH-50

Colour: Black

Tube: NR/SBR rubber

Cover: Black EPDM, weather, ozone and sea-water resistant.

Reinforcement: High strength synthetic cord, steel helix wire and antistatic copper wire

Size Available: 3" - 5"

Temperature: -25°C +70°C

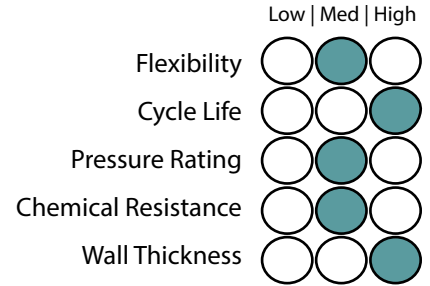

Construction

Use:

Hardwall hose designed to convey barite and bentonite and other abrasive materials from ship to oil rigs to consolidate the oil well. It withstands a tensile stress of 4 tons.

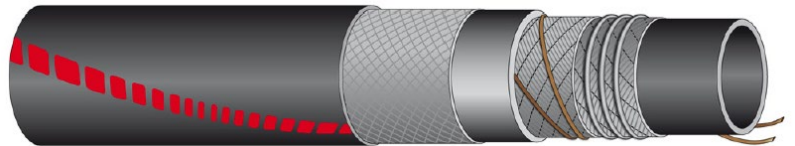

Specifications

Part Number	Size	Internal Diameter	Outside Diameter	Min. Bend Radius	Max. Working Pressure		Min. Burst Pressure		Vacuum
	inch	mm	mm	mm	bar	PSI	bar	PSI	mm hg
IH-AH-76	3"	76	96	390	10	150	40	600	675
IH-AH-102	4"	102	124	555	10	150	40	600	675
IH-AH-127	5"	127	150	730	10	150	40	600	675

1 2 3 4 5 6 7 8 9

RUBBER & COMPOSITE HOSE

Applications



Rubber Hose - Offshore

Suction/Discharge Potable Water Hose

Part No: IH-PW-35

Colour: Orange

Tube: IIR rubber

Cover: EDPM rubber, weathering, ozone and sea-water resistant.

Reinforcement: High strength synthetic cord divided by a layer of rubber plus steel helix wire.

Size Available: 2" - 4"

Temperature: -40°C +100°C

	Low Med High
Flexibility	<input type="radio"/> <input checked="" type="radio"/> <input type="radio"/>
Cycle Life	<input type="radio"/> <input type="radio"/> <input checked="" type="radio"/>
Pressure Rating	<input type="radio"/> <input checked="" type="radio"/> <input type="radio"/>
Chemical Resistance	<input type="radio"/> <input checked="" type="radio"/> <input type="radio"/>
Wall Thickness	<input type="radio"/> <input type="radio"/> <input checked="" type="radio"/>

Construction

Use:

Hardwall hose used for the suction and delivery of drinking water from ship to oil rig.

Standards:

PDA ABS Nr. 15-GE1415740-PDA

Reg. EC 1935/04 and EC 2023/06

Phthalates free

PAHs free (acc. to ZEK 01.4-08 Cat. 1)

Bisphenol A free

FDA tit.21 art

177.2600 aqueous foods

BfR XXI Cat.2 foods

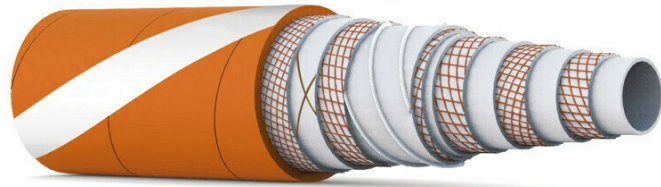

Specifications

Part Number	Size	Internal Diameter	Outside Diameter	Min. Bend Radius	Max. Working Pressure		Min. Burst Pressure		Vacuum
	inch	mm	mm	mm	bar	PSI	bar	PSI	bar
IH-PW-35-50	2"	51	71	220	35	525	105	1575	0.9
IH-PW-35-76	3"	76	101	350	35	525	105	1575	0.9
IH-PW-35-102	4"	102	132	610	35	525	105	1575	0.9
IH-PW-35-152	6"	152	186	900	35	525	105	1575	0.9

Tensile breaking load:

2000 kgf for inside diameter 2"

4000 kgf for inside diameter 3"

7000 kgf for all other diameters.

Applications



Rubber Hose - Offshore

Mud Bunkering Suction/Delivery Hose

Colour: Black

Tube: Black, smooth, NBR/PVC rubber compound

Cover: Black, smooth cloth impression, CR rubber compound, resistant to oil, grease, sea water, ozone and flame retardant

Reinforcement: High strength synthetic plies, with steel wire spirals and crossing copper wires for hose grounding

Size Available: 3" - 10"

Temperature: -40°C +100°C

Low | Med | High

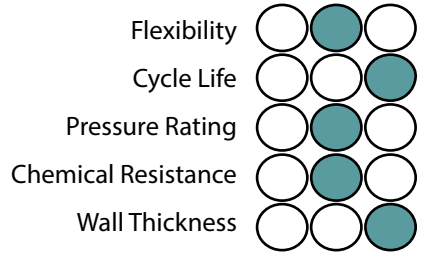

Construction

Use:

Suction and delivery hose, for drilling oil rig hose services, for petroleum muds and crude oil

Standards:

BS1435: 1987 S15/UNI EN 1765:99 S15



Specifications

Part Number	Size	Internal Diameter	Outside Diameter	Min. Bend Radius	Max. Working Pressure		Min. Burst Pressure		Vacuum
	inch	mm	mm	mm	bar	PSI	bar	PSI	Bar
IH-BUNKER-MUD-HW20-80	3	76	96	350	20	300	80	1200	0.9
IH-BUNKER-MUD-HW20-100	4	102	123	480	20	300	80	1200	0.9
IH-BUNKER-MUD-HW20-125	5	127	150	850	20	300	80	1200	0.9
IH-BUNKER-MUD-HW20-150	6	152	180	1000	20	300	80	1200	0.9
IH-BUNKER-MUD-HW20-200	8	203	237	1420	20	300	60	900	0.5
IH-BUNKER-MUD-HW20-250	10	254	290	1780	20	300	60	900	0.5

Applications



Rubber Hose - Offshore

Petrol/Oil Bunkering Hose

Colour: Black

Tube: Black, smooth, NBR rubber compound

Cover: Black, smooth cloth impression, CR rubber compound, resistant to oil, grease, sea water, ozone and flame retardant

Reinforcement: High strength synthetic plies, with steel wire spirals and 2 crossing copper wires for hose grounding

Size Available: 3" - 300"

Temperature: -30°C +100°C

Low | Med | High

Flexibility

Cycle Life

Pressure Rating

Chemical Resistance

Wall Thickness

Construction

Use:

Suction and delivery hose for crude oil and mixed fuels with aromatic contents up to 50%, offshore operations



Standards:

BS1435: 1987 S15/UNI EN 1765:99 S15

Specifications

Part Number	Size	Internal Diameter	Outside Diameter	Max. Working Pressure		Min. Burst Pressure		Bend Radius	Vacuum
	inch			mm	bar	PSI	bar		
IH-BUNKER-OIL-HW20-100	4	102	122	20	300	80	1200	630	0.9
IH-BUNKER-OIL-HW20-125	5	127	150	20	300	80	1200	760	0.9
IH-BUNKER-OIL-HW20-150	6	152	180	20	300	800	1200	1050	0.7
IH-BUNKER-OIL-HW20-200	8	203	237	20	300	60	900	1420	0.7
IH-BUNKER-OIL-HW20-250	10	254	290	20	300	60	900	1780	0.5
IH-BUNKER-OIL-HW20-300	12	302	344	20	300	60	900	2115	0.5

Applications



Rubber Hose - Offshore

FUEL AND OIL SD/16 EN 1360 Type 2

Part No.: IH-RFUELSD-16-%

Colour: Black

Tube: Black, smooth, antistatic NBR1 rubber compound.

Cover: Black, smooth, fire proof and antistatic cloth impression CR rubber compound, resistant to chemical products, ozone and weather.

Reinforcement: High strength synthetic plies, with steel spirals and 2 crossing copper wires for hose grounding.

Size Available: Various

Temperature: -30°C +70°C

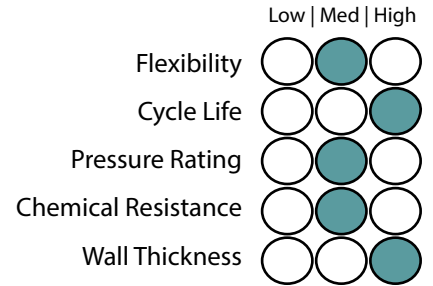

Construction

Use:

Suction and delivery hose for fuels and petroleum derivatives with aromatic contents up to 50%

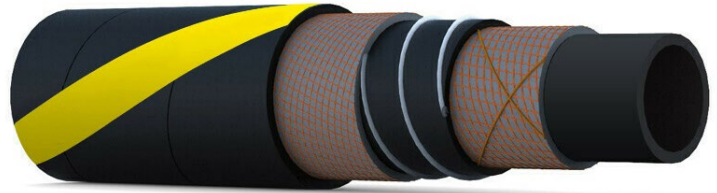

Standards

BS EN 1360

Specifications

Part Number	Size	Internal Diameter	Outside Diameter	Min. Bend Radius	Max. Working Pressure		Min. Burst Pressure		Vacuum
	inch	mm	mm	mm	bar	PSI	bar	PSI	mm hg
IH-RSD-FUEL-16-19	3/4"	19	30	100	16	240	48	720	0.9
IH-RSD-FUEL-16-25	1"	25	38	150	16	240	48	720	0.9
IH-RSD-FUEL-16-32	1 1/4"	32	45	175	16	240	48	720	0.9
IH-RSD-FUEL-16-35	1 3/8"	35	48	190	16	240	48	720	0.9
IH-RSD-FUEL-16-38	1 1/2"	38	51	225	16	240	48	720	0.9
IH-RSD-FUEL-16-40	1 9/16"	40	54	230	16	240	48	720	0.9

Applications



Rubber Hose - Oxygen - Welding

WELBLU 20 ISO3821 L/L

Part No.: IH-WELDB-20

Colour: Blue

Tube: Black, smooth, SBR rubber compound

Cover: Blue, smooth, SBR/EPDM rubber compound, abrasion and weather resistant

Reinforcement: High strength synthetic plies

Size Available: TBC

Temperature: -25°C +80°C

Low | Med | High

Flexibility

Cycle Life

Pressure Rating

Chemical Resistance

Wall Thickness

Construction

Use:

Delivery hose, oxygen line in welding equipments

Standards

ISO 3821

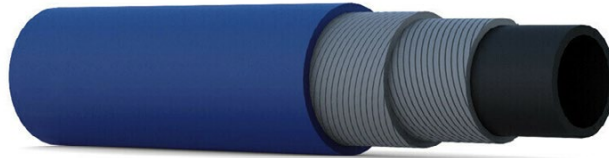

Specifications

Part Number	Size	Internal Diameter	Outside Diameter	Max. Working Pressure		Min. Burst Pressure	
	inch	mm	mm	bar	PSI	bar	PSI
IH-WELDB-20-06	1/4	6	13	20	300	60	900
IH-WELDB-20-08	5/16	8	15	20	300	60	900
IH-WELDB-20-09	23/64	9	16	20	300	60	900
IH-WELDB-20-10	3/8	10	17	20	300	60	900
IH-WELDB-20-12	1/2	13	23	20	300	60	900
IH-WELDB-20-15	5/8	16	26	20	300	60	900
IH-WELDB-20-20	3/4	19	30	20	300	60	900
IH-WELDB-20-25	1	25	37	20	300	60	900

Applications



Rubber Hose - Acetylene - Welding

WELRED 20 ISO3821 L/L

Part No.: IH-WELDB-25

Colour: Red

Tube: Black, smooth, SBR rubber compound

Cover: Red, smooth, SBR/EPDM rubber compound, abrasion and weather resistant

Reinforcement: High strength synthetic plies

Size Available: TBC

Temperature: -25°C +80°C

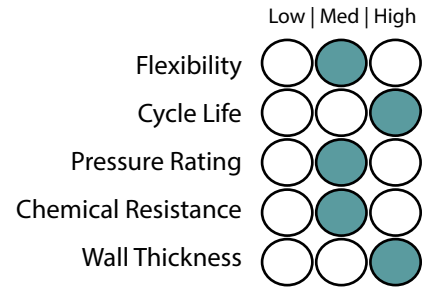

Construction

Use:

Delivery hose, acetylene line in welding equipments

Standards

ISO 3821

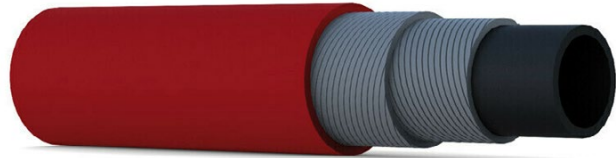

Specifications

Part Number	Size	Internal Diameter	Outside Diameter	Max. Working Pressure		Min. Burst Pressure	
	inch	mm	mm	bar	PSI	bar	PSI
IH-WELDR-25-06	1/4	6	13	20	300	60	900
IH-WELDR-25-08	5/16	8	15	20	300	60	900
IH-WELDR-25-09	23/64	9	16	20	300	60	900
IH-WELDR-25-10	3/8	10	17	20	300	60	900
IH-WELDR-25-12	1/2	13	23	20	300	60	900
IH-WELDR-25-15	5/8	16	26	20	300	60	900
IH-WELDR-25-20	3/4	19	30	20	300	60	900
IH-WELDR-25-25	1	25	37	20	300	60	900

Applications



Rubber Hose - LPG / Gas

LPG EN1762

Part No.: IH-LPG-EN1762
Colour: Black / Yellow Labelling
Tube: NBR Special, Black, Smooth, Electrically Conductive
Cover: CR, abrasion resistant, oil and weather resistant, cloth impression, pin pricked.
Reinforcement: Textile braided (sizes >75mm – wrapped), 2 crossed copper wires
Size Available: 3/4" - 4"
Temperature: -35°C +70°C

	Low Med High
Flexibility	<input type="radio"/> <input type="radio"/> <input checked="" type="radio"/>
Cycle Life	<input type="radio"/> <input type="radio"/> <input checked="" type="radio"/>
Pressure Rating	<input type="radio"/> <input checked="" type="radio"/> <input type="radio"/>
Chemical Resistance	<input type="radio"/> <input checked="" type="radio"/> <input type="radio"/>
Wall Thickness	<input type="radio"/> <input checked="" type="radio"/> <input type="radio"/>

Construction

Use:
 Suitable for delivery of Liquefied Petroleum Gas, LPG (Liquid or Gas) and Natural Gas.



Standards
 EN1762

Specifications

Part Number	Nominal Dia.			Working Pressure		Min. Bend Radius	Weight Per Mtr
	Inches	I.D (mm)	O.D (mm)	kPa	bar	mm	kg.
IH-LPG-EN1762-12	1/2"	13	24	2500	25	160	0.39
IH-LPG-EN1762-20	3/4"	19	32	2500	25	180	0.62
IH-LPG-EN1762-25	1"	25	38	2500	25	200	0.77
IH-LPG-EN1762-32	1 1/4"	32	46	2500	25	250	1.04
IH-LPG-EN1762-38	1 1/2"	38	54	2500	25	320	1.32
IH-LPG-EN1762-50	2"	51	67	2500	25	400	1.76
IH-LPG-EN1762-80	3"	76	93	2500	25	650	2.70
IH-LPG-EN1762-100	4"	102	124	2500	25	800	4.43

Safety Factor: 4:1 Standard Duty. (Burst Pressure: Working Pressure)

Applications



Rubber Hose - LPG / Gas

VAPFLEX

Part No.: IH-VAPFLEX-C / IH-VAPFLEX-H

Tube: Black antistatic smooth synthetic rubber

Reinforcement: Layers of woven braid and spirally wound textile material.

Optional: Electrical resistance by having embedded cross linked copper wire helix. For suction purposes embedded metallic spiral wire (SD). Part number example: IH-VAPFLEX-S&D-50-C

Cover: Black synthetic rubber, resistant to abrasion, oils and outdoor exposure (ozone and weather). Cover is fire resistant and pricked to allow gas permeation

Size Available: 1/2" - 4" Class C
3/4" - 4" Class H

Temperature: -20°C to +65°C Class C
-50°C to +65°C Class H

Approvals: AGA AS NZS 1869 Class C / H

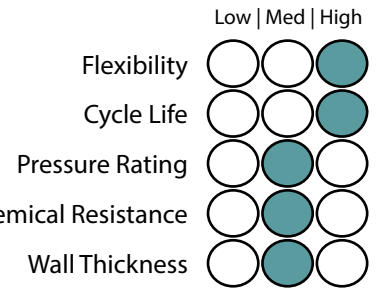

Construction

Use:

Suitable for delivery and transfer of CSG, Liquefied Petroleum Gas, LPG (Liquid or Gas), Natural Gas and Town Gas 62K2113659

Standards:

- Hose physical properties are manufactured in accordance to EN ISO 1402
- Ozone resistant and manufactured in accordance to EN ISO 7326
- Electrical resistance by using a metallic wire connection to conduct static electricity and manufactured in accordance to EN ISO 8031
- Rubber hoses and hose assemblies for liquefied petroleum gas, LPG (liquid or gaseous phase), and natural gas up to 25 bar (2,5 MPa) to EN 1762



Specifications

Class C Part Number	Nominal Dia.			Working Pressure		Burst Pressure		Min. Bend Radius	Weight Per Mtr
	Inches	I.D (mm)	O.D (mm)	kPa	bar	kPa	bar	mm	kg.
IH-VAPFLEX-12-C	1/2"	12.7	22.7	2600	26	10400	104	100	0.42
IH-VAPFLEX-16-C	5/8"	16	26.3	2600	26	10400	104	150	0.55
IH-VAPFLEX-19-C	3/4"	19	31	2600	26	10400	104	150	0.65
IH-VAPFLEX-25-C	1"	25	38	2600	26	10400	104	200	0.80
IH-VAPFLEX-32-C	1 1/4"	32	45	2600	26	10400	104	250	1.05
IH-VAPFLEX-38-C	1 1/2"	38	52	2600	26	10400	104	320	1.30
IH-VAPFLEX-50-C	2"	50	66	2600	26	10400	104	400	1.90
IH-VAPFLEX-75-C	3"	75	93	2600	26	10400	104	650	2.95
IH-VAPFLEX-100-C	4"	100	120	2600	26	10400	104	800	4.50

Class H Part Number	Nominal Dia.			Working Pressure		Burst Pressure		Min. Bend Radius	Weight Per Mtr
	Inches	I.D (mm)	O.D (mm)	kPa	bar	kPa	bar	mm	kg.
IH-VAPFLEX-19-H	3/4"	19	31	2600	26	10400	104	150	0.65
IH-VAPFLEX-25-H	1"	25	38	2600	26	10400	104	200	0.80
IH-VAPFLEX-32-H	1 1/4"	32	45	2600	26	10400	104	250	1.05
IH-VAPFLEX-38-H	1 1/2"	38	52	2600	26	10400	104	320	1.30
IH-VAPFLEX-50-H	2"	50	66	2600	26	10400	104	400	1.90
IH-VAPFLEX-75-H	3"	75	93	2600	26	10400	104	650	2.95
IH-VAPFLEX-100-H	4"	100	120	2600	26	10400	104	800	4.50

Applications



Rubber Hose - Hydraulic

SAE 100 R1AT

Part No.: IH-R1AT

Colour: Black

Tube: Synthetic oil resistant rubber.

Cover: Synthetic rubber - abrasion, ozone and weather resistant.

Reinforcement: 1 high tensile steel wire braid.

Size Available: 1/4" - 4"

Temperature: -40°C +120°C

Low | Med | High

Flexibility

Cycle Life

Pressure Rating

Chemical Resistance

Wall Thickness

Construction

Use:

High pressure hydraulic oils, air and water.



Standards:

EN 853 1SN

Specifications

Part Number	Size	Nominal Dia.		Max. Working Pressure		Min. Burst Pressure		Bend Radius
	inch	I.D (mm)	O.D (mm)	Bar	kPa	Bar	kPa	mm
IH-R1AT-04	1/4"	6.4	13.4	225	22500	900	90000	100
IH-R1AT-05	5/16"	7.9	50	215	21500	850	85000	105
IH-R1AT-06	3/8"	9.5	17.4	180	18000	720	72000	130
IH-R1AT-08	1/2"	12.7	20.3	160	16000	640	64000	180
IH-R1AT-10	5/8"	15.9	23.7	130	13000	520	52000	200
IH-R1AT-12	3/4"	19.0	27.7	105	10500	420	42000	240
IH-R1AT-16	1"	25.4	35.6	88	8800	352	35200	300
IH-R1AT-20	1 1/4"	31.8	43	63	6300	252	25200	420
IH-R1AT-24	1 1/2"	38.1	50.4	50	5000	200	20000	500
IH-R1AT-32	2"	50.8	63.5	40	4000	160	16000	630
IH-R1AT-38	2 3/8"	60.3	75	25	2500	100	10000	762
IH-R1AT-40	2 1/2"	63.5	79.5	25	2500	100	10000	762
IH-R1AT-48	3"	76.2	94.4	20	2000	80	8000	915
IH-R1AT-56	3 1/2"	90	105.5	15	1500	60	6000	1067
IH-R1AT-64	4"	101.6	177	10	1000	40	4000	1105

Applications



Rubber Hose - Hydraulic

SAE 100 R2AT

Part No.: IH-R2AT
Colour: Black
Tube: Synthetic oil resistant rubber.
Cover: Synthetic rubber - abrasion, ozone and weather resistant.
Reinforcement: 2 high-tensile steel wire braids.
Size Available: 1/4" - 4"
Temperature: -40°C +120°C

Low | Med | High

Flexibility

Cycle Life

Pressure Rating

Chemical Resistance

Wall Thickness

Construction

Use:
 High pressure hydraulic oils, air and water.



Standards:
 EN 853 2SN

Specifications

Part Number	Size	Nominal Dia.		Max. Working Pressure		Min. Burst Pressure		Bend Radius
	inch	I.D (mm)	O.D (mm)	Bar	kPa	Bar	kPa	mm
IH-R2AT-04	1/4"	6.4	15.1	400	40000	1600	160000	100
IH-R2AT-05	5/16"	7.9	16.7	350	35000	1400	140000	115
IH-R2AT-06	3/8"	9.5	19.1	330	33000	1320	132000	130
IH-R2AT-08	1/2"	12.7	22.2	276	27600	1103	110300	180
IH-R2AT-10	5/8"	15.9	25.4	250	25000	1000	100000	200
IH-R2AT-12	3/4"	19.0	29.4	215	21500	860	86000	240
IH-R2AT-16	1"	25.4	37.3	165	16500	660	66000	300
IH-R2AT-20	1 1/4"	31.8	48.3	125	12500	500	50000	420
IH-R2AT-24	1 1/2"	38.1	54.7	90	9000	360	36000	500
IH-R2AT-32	2"	50.8	67.4	80	8000	320	32000	630
IH-R2AT-38	2 3/8"	60.3	75.8	70	7000	280	28000	762
IH-R2AT-40	2 1/2"	63.5	82.5	69	6900	276	27600	762
IH-R2AT-48	3"	76.2	96	45	4500	179	17900	915
IH-R2AT-56	3 1/2"	90	107.5	28	2800	110	11000	1067
IH-R2AT-64	4"	101.6	118.5	25	2500	101	10100	1105

Applications



Rubber Hose - Hydraulic

SAE 100 R6

Part No.: IH-RR6

Colour: Black

Tube: Synthetic oil resistant rubber.

Cover: Synthetic rubber - abrasion, ozone and weather resistant.

Reinforcement: 1 textile braid.

Size Available: 1/4" - 1"

Temperature: -40°C +120°C

	Low Med High
Flexibility	<input type="radio"/> <input type="radio"/> <input checked="" type="radio"/>
Cycle Life	<input type="radio"/> <input type="radio"/> <input checked="" type="radio"/>
Pressure Rating	<input type="radio"/> <input type="radio"/> <input checked="" type="radio"/>
Chemical Resistance	<input type="radio"/> <input checked="" type="radio"/> <input type="radio"/>
Wall Thickness	<input type="radio"/> <input checked="" type="radio"/> <input type="radio"/>

Construction

Use:

Low pressure hydraulic oils, air and water.



Standards:

EN 854

Specifications

Part Number	Size	Nominal Dia.		Max. Working Pressure		Min. Burst Pressure		Bend Radius
	inch	I.D (mm)	O.D (mm)	Bar	kPa	Bar	kPa	mm
IH-RR6-04	1/4"	6.4	12.7	28	2800	110	11000	64
IH-RR6-05	5/16"	7.9	14.3	28	2800	110	11000	76
IH-RR6-06	3/8"	9.5	15.9	28	2800	110	11000	76
IH-RR6-08	1/2"	12.7	19.8	28	2800	110	11000	102
IH-RR6-10	5/8"	15.9	23	24	2400	97	9700	127
IH-RR6-12	3/4"	19.0	26	21	2100	83	8300	152
IH-RR6-16	1"	25.4	32.5	13	1300	52	5200	230

Applications



Rubber Hose - Hydraulic

SAE 100 R7

Part No.: IH-RR7

Colour: Black

Tube: Unplasticised polyester tube.

Cover: Black polyurethane outer cover.

Reinforcement: Single braid of polyester fibre.

Size Available: 3/16" - 1"

Temperature: -40°C +100°C

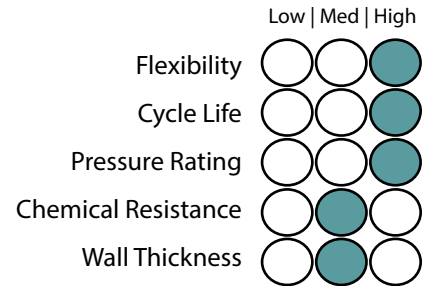

Construction

Use:

An all-purpose medium pressure hose suitable for many hydraulic and pneumatic systems. Compatible with hydraulic oils, grease, fuel oils, mineral oils and most phosphate esters.

Standards:

EN 853 2SN



Specifications

Part Number	Size	Nominal Dia.		Max. Working Pressure		Min. Burst Pressure		Bend Radius
	inch	I.D (mm)	O.D (mm)	Bar	kPa	Bar	kPa	mm
IH-RR7-03	3/16"	4.7	10.5	207	20700	827	82700	75
IH-RR7-04	1/4"	6.4	12.7	190	19000	190	19000	100
IH-RR7-06	3/8"	9.6	16.3	155	15500	620	62000	127
IH-RR7-08	1/2"	12.7	20.1	138	13800	552	55200	178
IH-RR7-10	5/8"	15.9	24.4	103	10300	412	41200	203
IH-RR7-12	3/4"	19.0	26.4	86	8600	345	34500	254
IH-RR7-16	1"	25.4	33.3	69	6900	276	27600	305

Applications



Rubber Hose - Hydraulic

SAE 100 R12

Part No.: IH-RR12

Colour: Black

Tube: Synthetic oil resistant rubber.

Cover: Synthetic rubber - abrasion, ozone and weather resistant.

Reinforcement: 4 high tensile steel wire spirals.

Size Available: 3/8" - 2"

Temperature: -40°C +100°C

Low | Med | High

Flexibility

Cycle Life

Pressure Rating

Chemical Resistance

Wall Thickness

Construction

Use:

Very high pressure hydraulics.



Standards:

EN 856

Specifications

Part Number	Size	Nominal Dia.		Max. Working Pressure		Min. Burst Pressure		Bend Radius
	inch	I.D (mm)	O.D (mm)	Bar	kPa	Bar	kPa	mm
IH-RR12-06	3/8"	9.5	20.1	276	27600	1100	110000	127
IH-RR12-08	1/2"	12.7	23.6	276	27600	1100	110000	178
IH-RR12-10	5/8"	15.9	27.2	276	27600	1100	110000	203
IH-RR12-12	3/4"	19.0	30.5	276	27600	1100	110000	241
IH-RR12-16	1"	25.4	37.8	276	27600	1100	110000	305
IH-RR12-20	1 1/4"	31.8	46.8	207	20700	825	82500	419
IH-RR12-24	1 1/2"	38.1	53.3	172	17200	625	62500	508
IH-RR12-32	2"	50.8	66.5	172	17200	625	62500	635

Applications



Rubber Hose - Hydraulic

SAE 100 R13/EN856

Part No.: IH-RR13
Colour: Black
Tube: Oil resistant synthetic rubber.
Cover: Synthetic rubber - abrasion, ozone and weather resistant.
Reinforcement: 4 or 6 high tensile steel wire spirals.
Size Available: 3/8" - 2"
Temperature: -40°C +100°C

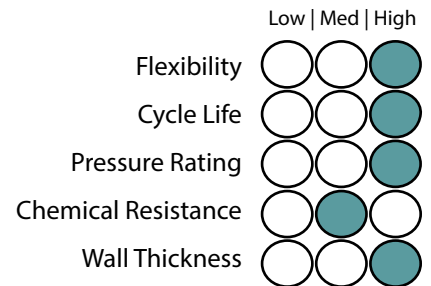

Construction

Use:
 Extremely high pressure hydraulics.

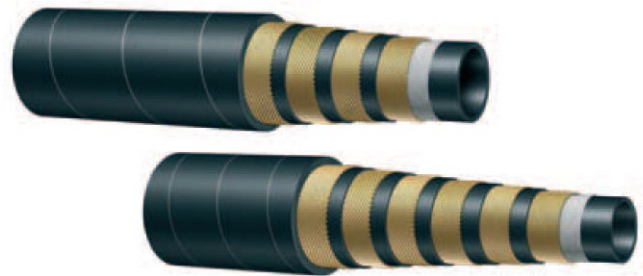

Standards:
 EN 856

Specifications

Part Number	Size	Nominal Dia.		Braid Layers No.	Max. Working Pressure		Min. Burst Pressure		Bend Radius mm
		I.D (mm)	O.D (mm)		Bar	kPa	Bar	kPa	
IH-RR13-06	3/8"	9.5	22.4	4	690	69000	2760	276000	152
IH-RR13-08	1/2"	12.7	25.5	4	517	51700	2070	207000	200
IH-RR13-12	3/4"	19	31.9	4	345	34500	1380	138000	241
IH-RR13-16	1"	25.4	38.5	4	345	34500	1380	138000	305
IH-RR13-20	1 1/4"	31.8	49.6	6	345	34500	1380	138000	419
IH-RR13-24	1 1/2"	38.1	57.1	6	345	34500	1380	138000	508
IH-RR13-32	2"	50.8	70.9	6	345	34500	1380	138000	635

Applications



Rubber Hose - Hygienic Food Grade

Edible Oil Hose

Part No.: IH-EHOH

Tube: White (NBR), compounded from material which meets FDA requirements.

Reinforcement: Single wire braid for additional safety from mechanical damage and kinking. Also aids in heat transfer for prolonged service life.

Cover: Grey (NBR) Meets FDA requirements.

Size Available: 1/2" - 3/4" (Larger sizes upon Request)

Temperature: -30°C +135°C (177°C Intermittent)

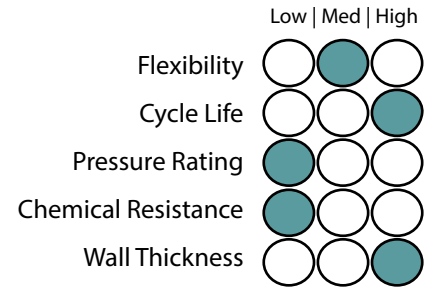

Construction

Use:

Edible liquids, vegetable oils, salad dressings, vinegar, mustard and meat products requiring a sanitary hose which will not impair taste. Excellent for service with hot oil fat filters and fryers.

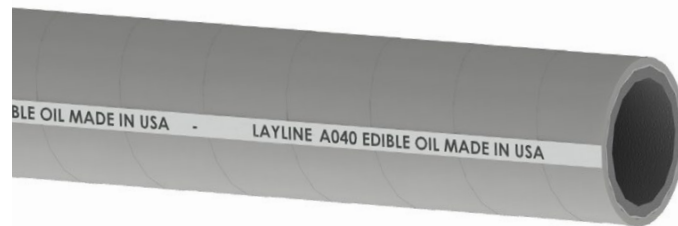

Specifications

Part Number	Nominal Dia.			Working Pressure		Min. Bend Radius	Weight Per Mtr
	Inches	I.D (mm)	O.D (mm)	kPa	psi	mm	kg.
IH-EHOH-08	1/2"	6	25.9	1723	250	150	0.69
IH-EHOH-10	5/8"	15	28.9	1723	250	175	0.76
IH-EHOH-12	3/4"	20	32.1	1723	250	200	0.87

Applications

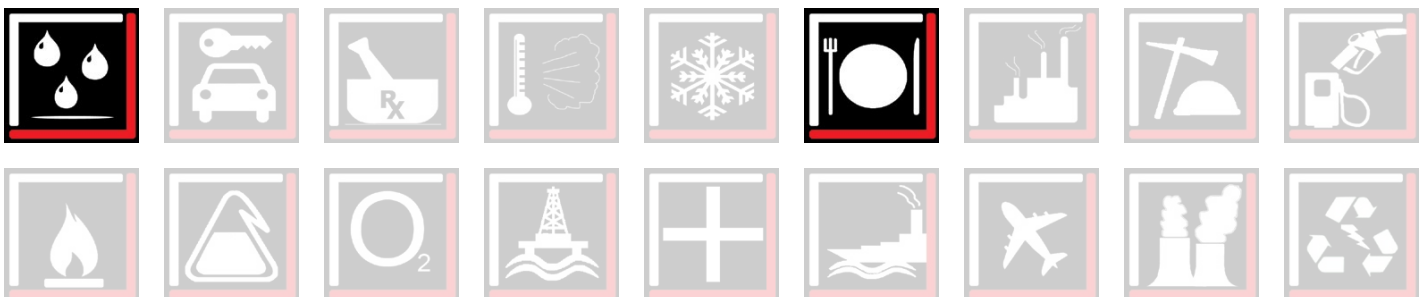

Rubber Hose - Hygienic Food Grade

Milk Tanker - Hard Wall

Part No.: IH-RMT
Tube: White NR
Reinforcement: High textile cords with embedded steel helix wire
Cover: Blue NR/EPDM - abrasion, ozone and oil resistant
Size Available: 1" - 4" (Larger sizes upon Request)
Temperature: -40°C +80°C
Safety Factor: 3:1

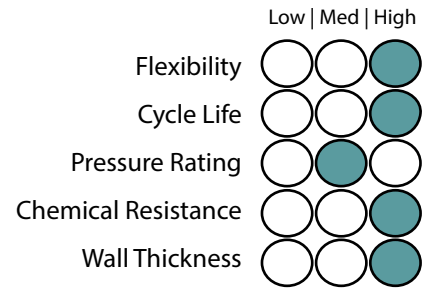

Construction

Use:

Liquid food and suction and delivery.
 Special construction for maximum flexibility in milk tanker applications. Sterilize with 5% soda solution.



Standards:

FDA

Specifications

Part Number	Nominal Dia.			Working Pressure		Min. Bend Radius	Vacuum	Weight Per Mtr
	Inches	I.D (mm)	O.D (mm)	kPa	psi	mm	%	kg.
IH-RMT-25	1"	25	35	1034	150	50	100	0.730
IH-RMT-32	1 1/4"	32	42	1034	150	64	100	0.900
IH-RMT-38	1 1/2"	38	48	1034	150	76	100	1.040
IH-RMT-40	1 9/16"	40	50	1034	150	80	100	1.090
IH-RMT-42	1 5/8"	42	52	1034	150	88	100	1.100
IH-RMT-45	1 3/4"	45	52	1034	150	90	100	1.130
IH-RMT-50	2"	51	61	1034	150	100	100	1.420
IH-RMT-65	2 1/2"	63	75	1034	150	126	100	2.010
IH-RMT-80	3"	76	88	1034	150	228	90	2.590
IH-RMT-100	4"	102	116	1034	150	306	90	3.850

Rubber Hose - Hygienic Food Grade - Feedflex

Feedflex Milk Suction & Delivery Hose

Part No.: IH-MILK-B

Tube: White, smooth NBR rubber compound, food quality odourless and taste free

Reinforcement: High strength synthetic plies with steel wire spirals

Cover: Blue, corrugated, cloth impression NBR rubber, resistant to abrasion, ozone and weather

Size Available: 1-1/4" to 6" (Larger sizes upon Request)

Temperature: -40°C +80°C sterilization at 110°C for 30 minutes

Safety Factor: 3:1

Low | Med | High

Flexibility

Cycle Life

Pressure Rating

Chemical Resistance

Wall Thickness

Construction

Use:

Suction and delivery hose for milk and fatty foods, very flexible

Standards:

FDA title 21 art.177.2600 (f) for fatty foods, BfR, ADI free, PHTHALATE free, D.M. 21/03/73, CE 1935/2004

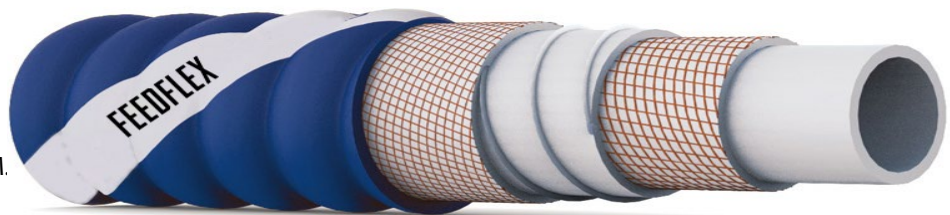

Specifications

Part Number	Nominal Dia.			Working Pressure		Min. Bend Radius	Vacuum	Weight
	Inches	I.D (mm)	O.D (mm)	kPa	psi	mm	Bar	Kg/m
IH-25-MILK-B	1"	25	35	1034	150	50	0.9	0.73
IH-32-MILK-B	1 1/4"	32	44	1034	150	80	0.9	1.00
IH-38-MILK-B	1 1/2"	38	50	1034	150	125	0.9	1.26
IH-51-MILK-B	2"	51	65	1034	150	150	0.9	1.85
IH-63-MILK-B	2 1/2"	63.5	77	1034	150	160	0.9	2.10
IH-76-MILK-B	3"	76	92	1034	150	190	0.9	2.90
IH-102-MILK-B	4"	102	118	1034	150	200	0.9	4.10
IH-152-MILK-B	6"	152	172	1034	150	425	0.9	8.30

Alternative products:

Refer to Encapsulated PTFE - Page 15

Applications



Rubber Hose - Hygienic Food Grade

Liquid Suction

Part No.: IH-RFS
Tube: White NR
Reinforcement: High textile cords with embedded steel helix wire
Cover: Red SBR/EPDM - abrasion and ozone resistant
Size Available: 1" - 4" (Larger sizes upon Request)
Temperature: -30°C +80°C
Safety Factor: 3:1

	Low Med High
Flexibility	<input type="radio"/> <input type="radio"/> <input checked="" type="radio"/>
Cycle Life	<input type="radio"/> <input type="radio"/> <input checked="" type="radio"/>
Pressure Rating	<input type="radio"/> <input checked="" type="radio"/> <input type="radio"/>
Chemical Resistance	<input type="radio"/> <input type="radio"/> <input checked="" type="radio"/>
Wall Thickness	<input type="radio"/> <input type="radio"/> <input checked="" type="radio"/>

Construction

Use:
 Liquid food and alcoholic beverages suction and delivery - max 50% proof. Special construction for maximum flexibility. Sterilize with 5% soda solution.



Standards:
 FDA

Specifications

Part Number	Nominal Dia.			Working Pressure		Min. Bend Radius	Vacuum	Weight Per Mtr
	Inches	I.D (mm)	O.D (mm)	kPa	psi	mm	%	kg.
IH-RFS-23	1"	23	37	1034	150	75	100	0.910
IH-RFS-38	1 1/2"	38	50	1034	150	114	100	1.250
IH-RFS-40	1 9/16"	40	52	1034	150	120	100	1.300
IH-RFS-51	2"	51	63	1034	150	153	100	1.610
IH-RFS-76	3"	76	88	1034	150	228	90	2.530
IH-RFS-102	4"	102	116	1034	150	306	90	3.510

Applications



Rubber Hose - Hygienic Food Grade - Feedflex

Feedflex Beverage Suction & Delivery

Part No.: IH-BEV-R

Tube: White, smooth butyl rubber compound, food quality odourless and taste free

Reinforcement: High strength synthetic plies with steel wire spirals

Cover: Red, corrugated, cloth impression EPDM rubber, resistant to abrasion, ozone and weather

Size Available: 1-1/4" - 4" (Larger sizes upon Request)

Temperature: -40°C +120°C sterilization at 110°C for 30 minutes

Safety Factor: 3:1

Low | Med | High

Flexibility

Cycle Life

Pressure Rating

Chemical Resistance

Wall Thickness

Construction

Use:

Suction and delivery hose for beer, wine, alcohol, soft drinks, very flexible

Standards:

FDA title 21 art.177.2600 (e) for liquid foods, BfR, ADI free, PHTHALATE free, CE 1935/2004

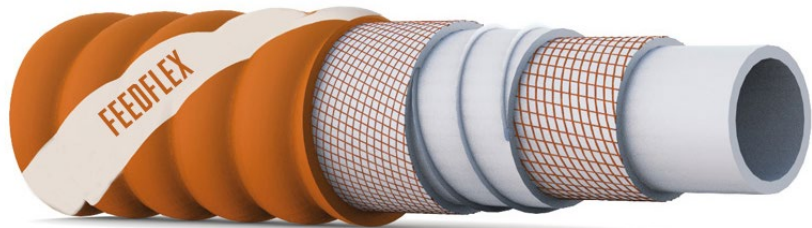

Specifications

Part Number	Nominal Dia.			Working Pressure		Min. Bend Radius	Vacuum	Weight
	Inches	I.D (mm)	O.D (mm)	kPa	psi	mm	Bar	Kg/m
IH-25-BEV-R	1"	25		1241	180	85	0.9	0.82
IH-32-BEV-R	1 1/4"	32	44	1241	180	115	0.9	1.04
IH-38-BEV-R	1 1/2"	38	50	1241	180	140	0.9	1.51
IH-51-BEV-R	2"	51	64	1241	180	195	0.9	1.95
IH-63-BEV-R	2 1/2"	63.5	80	1241	180	270	0.9	3.10
IH-76-BEV-R	3"	76	94	1241	180	285	0.9	3.60
IH-102-BEV-R	4"	102	120	1241	180	335	0.9	5.10

Alternative products:

Refer to Encapsulated PTFE - Page 15

Applications



Rubber Hose - Hygienic Food Grade

Milk Tanker - Hard Wall Crush Resistant

Part No.: IH-RMTC
Tube: White NR - abrasion resistant
Reinforcement: High textile cords with antistatic wire
Cover: Black conductive SBR/NR - abrasion and ozone resistant
Size Available: 3" - 4 5/16" (Larger sizes upon Request)
Temperature: -30°C +80°C
Safety Factor: 3:1

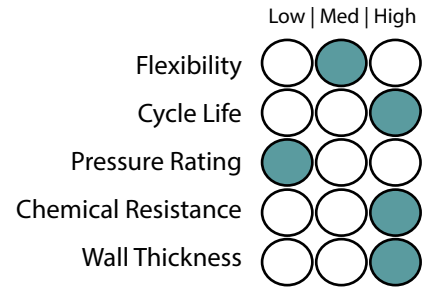

Construction

Use:
 Bulk food and material delivery.
 Specially designed for grain, flour and plastic pellets transfer.



Standards:
 FDA

Specifications

Part Number	Nominal Dia.			Working Pressure		Min. Bend Radius	Vacuum	Weight Per Mtr
	Inches	I.D (mm)	O.D (mm)	kPa	psi	mm	%	kg.
IH-RMTC-80	3"	75	93	517	75	-	-	2.380
IH-RMTC-90	3 1/2"	90	102	517	75	-	-	2.130
IH-RMTC-100	4"	100	120	517	75	-	-	3.550
IH-RMTC-102	4"	102	118	517	75	-	-	2.760
IH-RMTC-100	4"	102	120	517	75	-	-	3.180
IH-RMTC-110	4 5/16"	110	122	517	75	-	-	2.550

Applications



Composite Hose Design

Introduction

Composite hoses are made from quality materials. The inner films and fabrics provide optimum chemical resistance. Protected with the PVC impregnated outer covers, composite hoses provide the strength and versatility for all petrol and chemical applications.

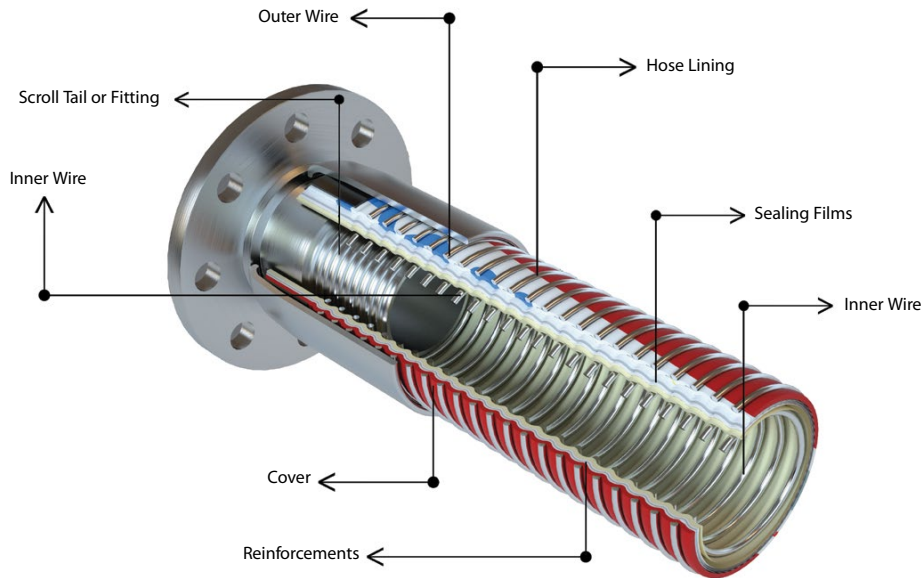

Composite Hoses are designed to meet the most demanding transfer applications such as:

- Hydrocarbon
- Chemical
- Cryogenic

Composite hoses are reinforced offering strength, light weight, flexibility and versatility for variations in pressure, temperature and product conveyance compatibility. Composite Hose meets various Australian & International Standards and is available in sizes from 25mm – 250mm.

Application

Transfer for road and rail tanker loading and discharging, storage tank and in-plant use
 Conveyants – petrol, diesel, kerosene, black oils, tallow and heavy lubricating products
 Ship-to-shore and ship-to-ship transfers, dock side and general shipboard use.

Rope Lagging

All hoses can be supplied with rope lagging. It is necessary to specify at time of ordering. Polypropylene rope is used as lagging. Lagging insulates and protects the hose from abrasion and heat transfer.

Nominal Dia.		Rope Diameter	Weight
mm	inches	mm	Kg/M
25	1	8	0.48
32	1 1/4	8	0.65
39	1 1/2	8	0.70
51	2	8	0.80
63	2 1/2	10	1.25
76	3	10	1.50
102	4	10	2.00
152	6	12	2.90

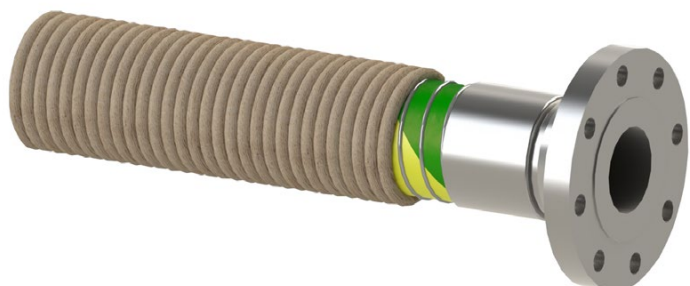

Composite Hose Design

Hose Assemblies

Due to the often hazardous conveyance used it is recommended that composite hose should only be used with properly fixed fittings. Composite hoses are normally fitted by the wire whipped method or by external crimp. All hoses have a 6 to 1 safety factor.

Testing

All hose assemblies must be pressure tested hydrostatically to one and a half times the maximum recommended working pressure and electrically tested to confirm continuity per:

- AS2683, AS2594, AS1180, AS2117
- BSEN13765:2010, BS5842:1980
- EN13766:2010, EN ISO 8031:2009, EN ISO 1402

Fittings

A wide range of fittings can be supplied such as Camlocks, Screwed fittings, flanges etc. Material fittings - Stainless Steel, Aluminum, Custom.

Composite Hose Handling Guide

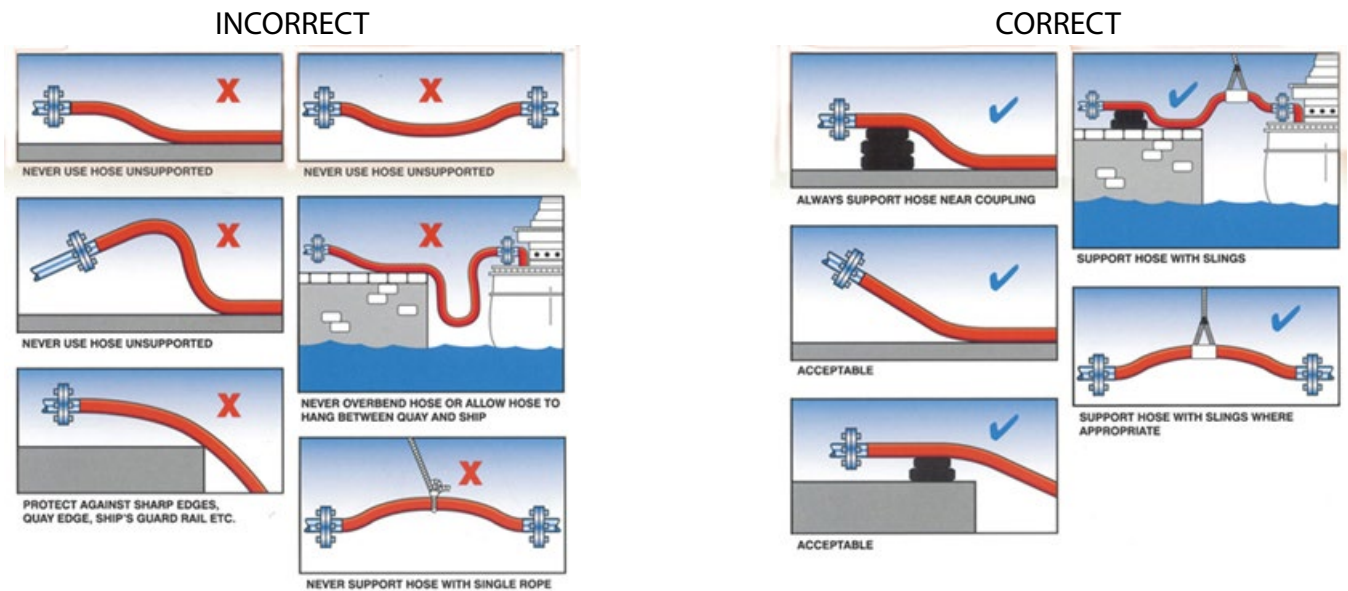

Pressure Loss Flow Chart

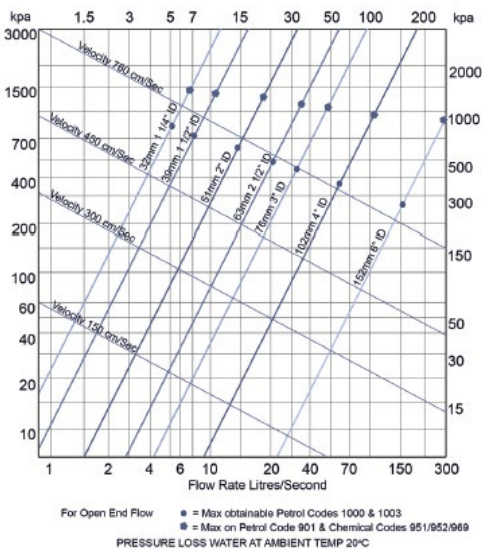

Fittings for Composite Hose (Swagged or Wire Whipped)

QL2

Female Camlock

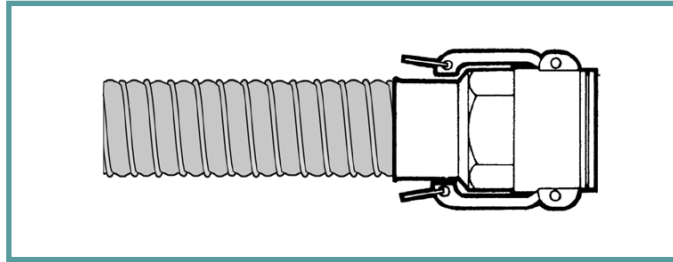

QL1

Male Camlock

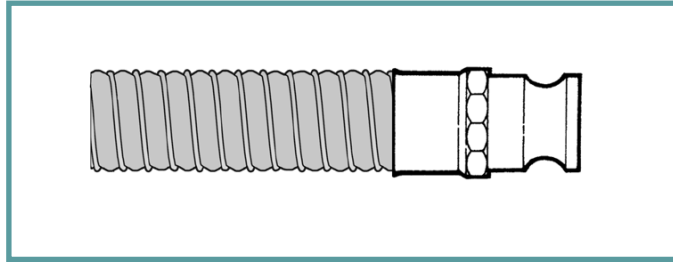

AF1

Fixed Male

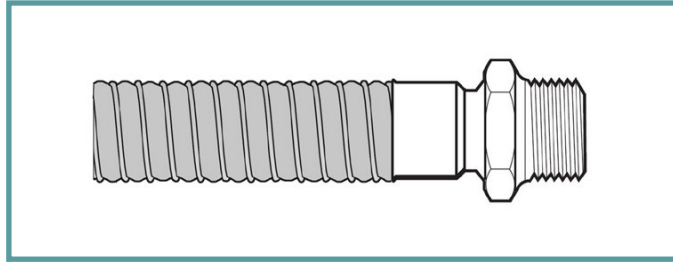

AF2

Swivel Female

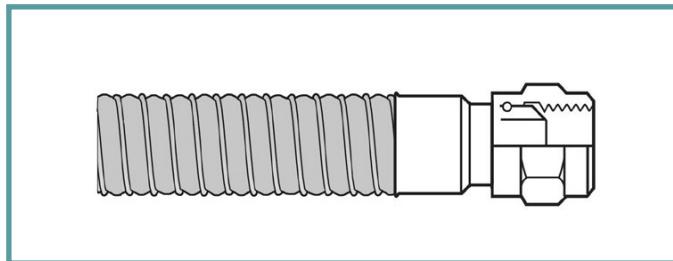

AF3

Fixed Flange

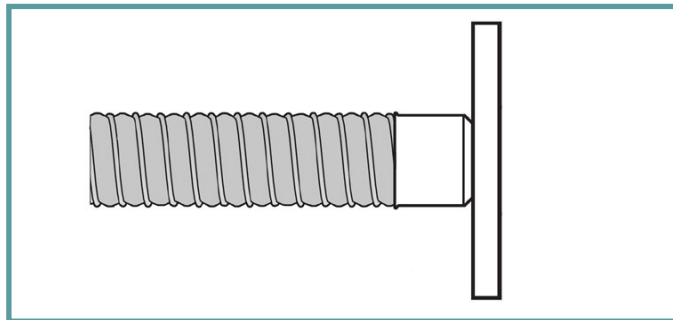

AF4

Floating Flange

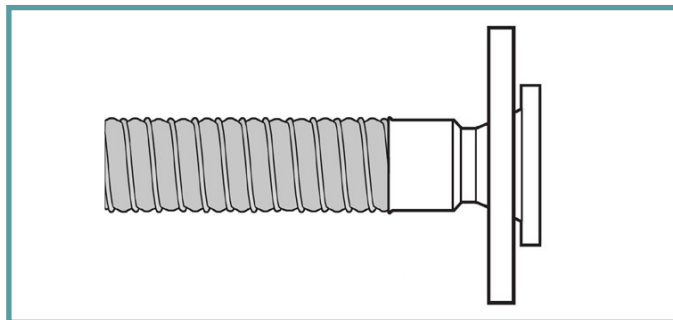

Composite Hose - Petroleum

Composite Hose - Code 1000

Part No.: CH-1000

Colour: Green / Yellow Stripe

Inner Wire: Galvanised Steel

Reinforcement: Polypropylene Fabric and Films

Outer Wire: Galvanised Steel

Crimping: Swagged or Wire Whipped

Size Available: 1" - 6"

(Larger sizes upon Request)

Temperature: -20°C +80°C

Type: 1

Grade: 3

Electrical kind: 1

Low | Med | High

Flexibility

Cycle Life

Pressure Rating

Chemical Resistance

Wall Thickness

Construction

Use:

A robust but light weight hose designed for ease of use as a road tanker delivery hose for petrol, diesel and low viscosity oils.

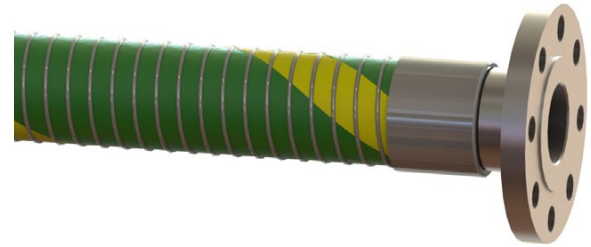

Standards:

AS2683

Specifications

Part Number	Nominal Dia.			Max. Working Pressure		Max. Burst Pressure		Min. Bend Radius	Weight Per Mtr
	Inches	I.D (mm)	O.D (mm)	kPa	psi	kPa	psi	mm	kg.
CH-1000-25	1"	25	32	700	101	2800	406	60	0.8
CH-1000-32	1 1/4"	32	38	700	101	2800	406	75	1.0
CH-1000-40	1 1/2"	39	48	700	101	2800	406	75	1.3
CH-1000-50	2"	51	63	700	101	2800	406	90	1.6
CH-1000-65	2 1/2"	63	75	700	101	2800	406	100	2.4
CH-1000-75	3"	76	90	700	101	2800	406	125	2.8
CH-1000-100	4"	102	112	700	101	2800	406	200	4.1
CH-1000-150	6"	152	170	700	101	2800	406	400	7.8

Safety Factor: 4:1 Standard Duty. (Burst Pressure: Working Pressure)

Applications



Composite Hose - Petroleum

Composite Hose - Code 1003

Part No.: CH-1003

Colour: Yellow / Green Stripe

Inner Wire: Aluminium

Reinforcement: Polypropylene Fabric and Films

Outer Wire: Galvanised Steel

Crimping: Swagged or Wire Whipped

Size Available: 2" - 4"

(Larger sizes upon Request)

Temperature: -20°C +80°C

Type: 1

Grade: 3

Electrical kind: 1

Low | Med | High

Flexibility

Cycle Life

Pressure Rating

Chemical Resistance

Wall Thickness

Construction

Use:

Its principal use is for gravity and low pressure delivery of petrol and diesel to forecourts from road tankers. Light weight makes operating and handling easy.

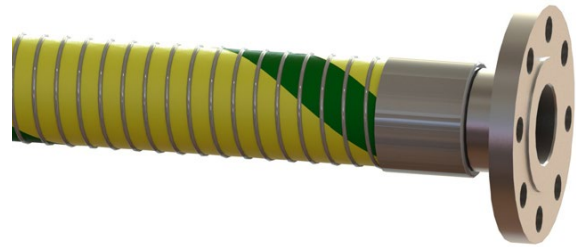

Standards:

AS2683

Specifications

Part Number	Nominal Dia.			Max. Working Pressure		Max. Burst Pressure		Min. Bend Radius	Weight Per Mtr
	Inches	I.D (mm)	O.D (mm)	kPa	psi	kPa	psi	mm	kg.
CH-1003-50	2"	51	63	600	58	1600	232	90	1.25
CH-1003-65	2 1/2"	63	75	500	58	1600	232	100	1.75
CH-1003-75	3"	76	90	500	58	1600	232	125	2.0
CH-1003-100	4"	102	112	400	58	1600	232	200	2.5

Safety Factor: 4:1 Standard Duty. (Burst Pressure: Working Pressure)

Applications



Composite Hose - Petroleum

Composite Hose - Code 901

Part No.: CH-901

Colour: Black

Inner Wire: Galvanised Steel

Reinforcement: Polypropylene Fabric and Films

Outer Wire: Galvanised Steel

Crimping: Swagged or Wire Whipped

Size Available: 1" - 6"

(Larger sizes upon Request)

Temperature: -20°C +80°C

Type: 2

Grade: 2

Electrical kind: A - Continuous

Low | Med | High

Flexibility

Cycle Life

Pressure Rating

Chemical Resistance

Wall Thickness

Construction

Use:

A tough, high strength oil and petroleum transfer hose. Applications such as rail car loading and unloading, road tanker bottom loading, lubricating oil plant hose exchanges. The hose is lined and reinforced with polypropylene fabrics and sealed with polypropylene films. The cover is a wear and weatherproof layer of PVC coated polyester.

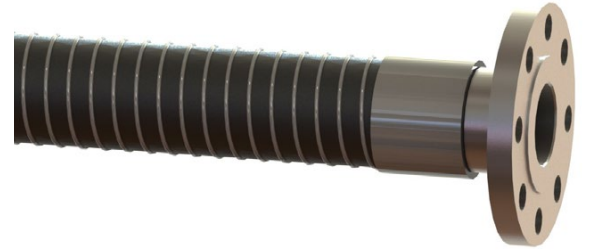

Applicable Standards

AS2117, BS5842:1980, EN13765, AS2683

Specifications

Part Number	Nominal Dia.			Max. Working Pressure		Max. Burst Pressure		Min. Bend Radius	Weight Per Mtr
	Inches	I.D (mm)	O.D (mm)	kPa	psi	kPa	psi	mm	kg.
CH-901-25	1"	25	35	1400	203	5600	812	100	0.9
CH-901-32	1 1/4"	32	42	1400	203	5600	812	125	1.3
CH-901-40	1 1/2"	39	50	1400	203	5600	812	140	1.5
CH-901-50	2"	51	65	1200	174	4800	696	170	1.9
CH-901-65	2 1/2"	63	76	1000	145	4000	580	200	3.0
CH-901-75	3"	76	90	1000	145	4000	580	270	3.4
CH-901-100	4"	102	120	1000	145	4000	580	340	6.5
CH-901-150	6"	152	180	1000	145	4000	580	700	12.4

Safety Factor: 4:1 Standard Duty. (Burst Pressure: Working Pressure)

Applications



Composite Hose - Vapour Recovery

Composite Hose - Code 400 Vapour

Part No.: CH-400

Colour: Standard Black / Yellow Stripe

Inner Wire: Galvanised Steel

Reinforcement: Polypropylene Fabric and Films

Outer Wire: Galvanised Steel

Crimping: Swagged or Wire Whipped

Size Available: 4"

(Larger sizes upon Request)

Temperature: -20°C +80°C

Type: 1

Grade: 3

Electrical kind: 1

Low | Med | High

Flexibility

Cycle Life

Pressure Rating

Chemical Resistance

Wall Thickness

Construction

Use:

Built for vapour return of hydrocarbon products in marine, road and rail tanker operations. Suitable for the collection or transfer of hydrocarbon vapors within the oil industry. Vapour hoses are robust, but light weight and extremely flexible.

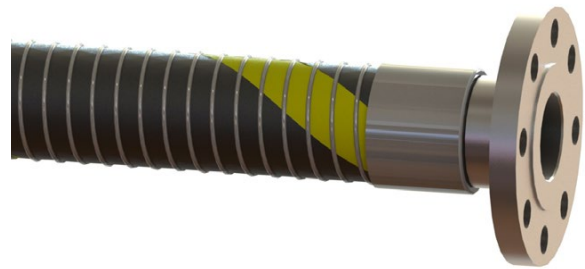

Applicable Standards

AS2683, BSEN13765: Type 1

Specifications

Part Number	Nominal Dia.			Max. Working Pressure		Max. Burst Pressure		Min. Bend Radius	Weight Per Mtr
	Inches	I.D (mm)	O.D (mm)	kPa	psi	kPa	psi	mm	kg.
CH-400-100	4'	102	112	400	58	1600	232	200	4.1

Safety Factor: 4:1 Standard Duty. (Burst Pressure: Working Pressure)

Applications



Composite Hose - Chemical

Composite Hose - Code 951

Part No.: CH-951

Colour: Standard Grey / Red Stripe

Inner Wire: Polypropylene Coated Steel

Reinforcement: Polypropylene Fabric and Films

Outer Wire: Galvanised Steel

Crimping: Swagged or Wire Whipped

Size Available: 1" - 4"

(Larger sizes upon Request)

Temperature: -20°C +80°C

Type: 2/3

Grade: 2

Electrical kind: B - Discontinuous

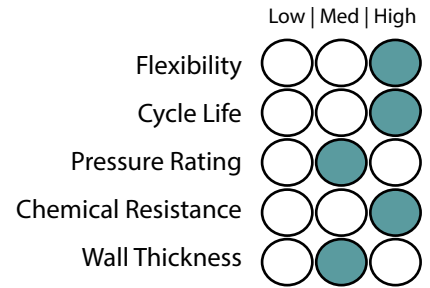

Construction

Use:

Manufactured from multiple layers of polypropylene fabrics and films. Some typical applications are in plant transfer of liquid chemicals, vegetable and mineral oils and loading and unloading of these products to and from road tankers, rail tankers and marine tanker ships.

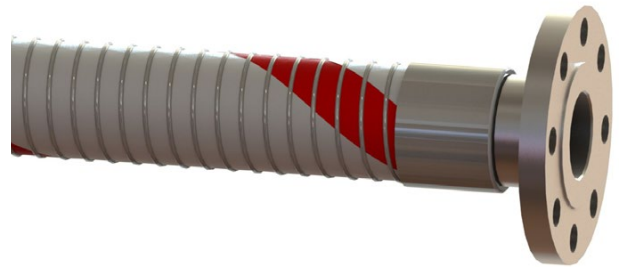

Applicable Standards

AS2117, BSEN13765: Type 3, BS5842:1980, AS2594

Specifications

Part Number	Nominal Dia.			Max. Working Pressure		Max. Burst Pressure		Min. Bend Radius	Weight Per Mtr
	Inches	I.D (mm)	O.D (mm)	kPa	psi	kPa	psi	mm	kg.
CH-951-25	1"	25	38	1400	203	5600	812	100	0.9
CH-951-32	1 1/4"	32	45	1400	203	5600	812	125	1.3
CH-951-40	1 1/2"	39	50	1400	203	5600	812	140	1.5
CH-951-50	2"	51	65	1200	174	4800	696	170	1.8
CH-951-63	2 1/2"	63	78	1000	145	4000	580	200	2.7
CH-951-75	3"	76	92	1000	145	4000	580	270	3.3
CH-951-100	4"	102	120	1000	145	4000	580	340	6.3

Safety Factor: 4:1 Standard Duty. (Burst Pressure: Working Pressure)

Applications



Composite Hose - Chemical

Composite Hose - Code 952

Part No.: CH-952

Colour: Standard Grey / Blue Stripe

Inner Wire: Polypropylene Coated Steel

Reinforcement: Polypropylene Fabric and Films

Outer Wire: Stainless Steel

Crimping: Swagged or Wire Whipped

Size Available: 1" -4"

(Larger sizes upon Request)

Temperature: -20°C +80°C

Type: 2/3

Grade: 2

Electrical kind: B - Discontinuous

Low | Med | High

Flexibility

Cycle Life

Pressure Rating

Chemical Resistance

Wall Thickness

Construction

Use:

This hose is identical in its construction to CODE 951 with the exception of having an outer wire of stainless steel. Like CODE 951, CODE 952 is typically used in applications involving plant transfer of liquid chemicals, vegetable and mineral oils and loading and unloading of these products to and from, road tankers, rail tankers and marine tanker ships.

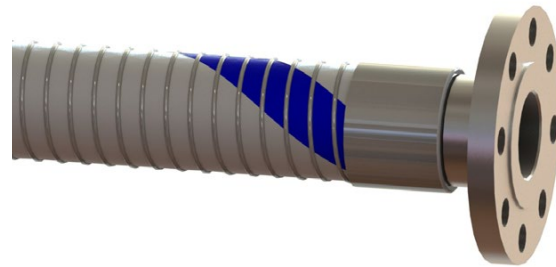

Applicable Standards

AS2117, BSEN13765: Type 3, BS5842:1980, AS2594

Specifications

Part Number	Nominal Dia.			Max. Working Pressure		Max. Burst Pressure		Min. Bend Radius	Weight Per Mtr
	Inches	I.D (mm)	O.D (mm)	kPa	psi	kPa	psi	mm	kg.
CH-952-25	1"	25	38	1400	203	5600	812	100	0.9
CH-952-32	1 1/4"	32	45	1400	203	5600	812	125	1.3
CH-952-40	1 1/2"	39	50	1400	203	5600	812	140	1.5
CH-952-50	2"	51	65	1200	174	4800	696	170	1.8
CH-952-65	2 1/2"	63	78	1000	145	4000	580	200	2.7
CH-952-75	3"	76	92	1000	145	4000	580	270	3.3
CH-952-100	4"	102	120	1000	145	4000	580	340	6.3

Safety Factor: 4:1 Standard Duty. (Burst Pressure: Working Pressure)

Applications



Composite Hose - Chemical

Composite Hose - Code 969

Part No.: CH-969

Colour: Orange / Blue Stripe

Inner Wire: Stainless Steel

Reinforcement: Polypropylene Fabric and Films

Outer Wire: Galvanised Steel

Crimping: Swagged or Wire Whipped

Size Available: 1" - 6" (Larger sizes upon Request)

Temperature: -20°C +80°C

Type: 2/3

Grade: 2

Electrical kind: A - Continuous

Low | Med | High

Flexibility

Cycle Life

Pressure Rating

Chemical Resistance

Wall Thickness

Construction

Use:

Manufactured from multiple layers of polypropylene fabrics and films. The inner wire helix is stainless steel 316. The outer wire helix is galvanised steel. Again, CODE 969 is typically used in applications involving plant transfer of liquid chemicals, vegetable and mineral oils and loading and unloading of these products to and from, road tankers, rail tankers and marine tanker ships.

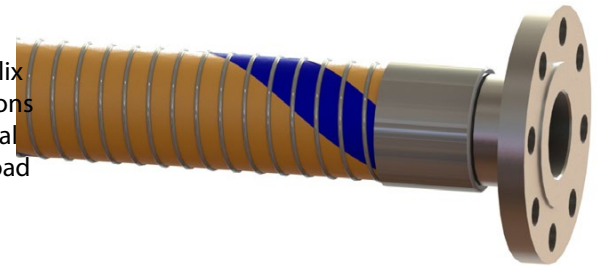

Applicable Standards

AS2117, BSEN13765:Type 3, BS5842:1980, AS2594

Specifications

Part Number	Nominal Dia.			Max. Working Pressure		Max. Burst Pressure		Min. Bend Radius	Weight Per Mtr
	Inches	I.D (mm)	O.D (mm)	kPa	psi	kPa	psi	mm	kg.
CH-969-25	1"	25	38	1400	203	5600	812	100	0.9
CH-969-32	1 1/4"	32	45	1400	203	5600	812	125	1.3
CH-969-40	1 1/2"	39	50	1400	203	5600	812	140	1.5
CH-969-50	2"	51	65	1200	174	4800	696	170	1.9
CH-969-65	2 1/2"	63	78	1000	145	4000	580	200	3
CH-969-75	3"	76	92	1000	145	4000	580	270	3.4
CH-969-100	4"	102	120	1000	145	4000	580	340	6.5
CH-969-150	6"	152	180	1000	145	4000	580	700	12.4

Safety Factor: 4:1 Standard Duty. (Burst Pressure: Working Pressure)

Applications



Composite Hose - Chemical

Composite Hose - Code 969ASS

Part No.: CH-969ASS

Colour: Orange / Blue Stripe

Inner Wire: Stainless Steel

Reinforcement: Polypropylene Fabric and Films

Outer Wire: Stainless Steel

Crimping: Swagged or Wire Whipped

Size Available: 1" - 4" (Larger sizes upon Request)

Temperature: -20°C +80°C

Type: 2/3

Grade: 2

Electrical kind: A - Continuous

Low | Med | High

Flexibility

Cycle Life

Pressure Rating

Chemical Resistance

Wall Thickness

Construction

Use:

This hose is identical in its construction to CODE 969 with the exception of having an outer wire of stainless steel 316. Like CODE 969, CODE 969ASS is typically used in applications involving plant transfer of liquid chemicals, vegetable and mineral oils and loading and unloading of these products to and from, road tankers, rail tankers and marine tanker ships.

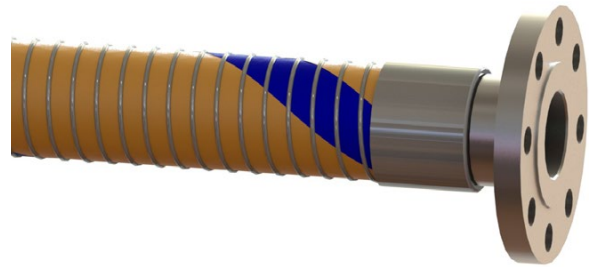

Applicable Standards

AS2117, BSEN13765: Type 3, BS5842:1980, AS2594

Specifications

Part Number	Nominal Dia.			Max. Working Pressure		Max. Burst Pressure		Min. Bend Radius	Weight Per Mtr
	Inches	I.D (mm)	O.D (mm)	kPa	psi	kPa	psi	mm	kg.
CH-969ASS-25	1"	25	38	1400	203	5600	812	100	0.9
CH-969ASS-40	1 1/2"	39	50	1400	203	5600	812	140	1.5
CH-969ASS-50	2"	51	65	1400	203	5600	812	170	1.8
CH-969ASS-65	2 1/2"	63	78	1200	174	4800	696	200	2.7
CH-969ASS-75	3"	76	92	1000	145	4000	580	270	3.3
CH-969ASS-100	4"	100	120	1000	145	4000	580	340	6.3
CH-969ASS-150	6"	152	180	1000	145	4000	580	700	12.2

Safety Factor: 4:1 Standard Duty. (Burst Pressure: Working Pressure)

Applications



Composite Hose - Chemical

Composite Hose - 900HD PTFE

Part No.: CH-PTFE900
Colour: Purple / Yellow Stripe
Inner Wire: PVDF Coated Stainless Steel
Lining: White PVDF high wall thickness
Cover: FEP seamless tubular extruded film
Reinforcement: Polyester Fabrics
Outer Wire: Stainless Steel
Crimping: Swagged or Wire Whipped
Size Available: 3/4" - 12"
Temperature: -40°C +125°C

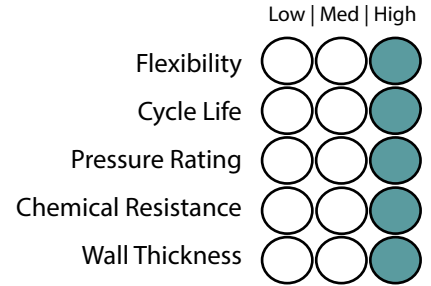

Construction

Use:

Designed for very aggressive chemicals. It is used in such applications as transfer of all the Chlorine derivatives, Hydrochloric acid, Nitric and Sulphuric acid. Heavy Duty construction, can be used in general for the most arduous Industrial and Marine applications.

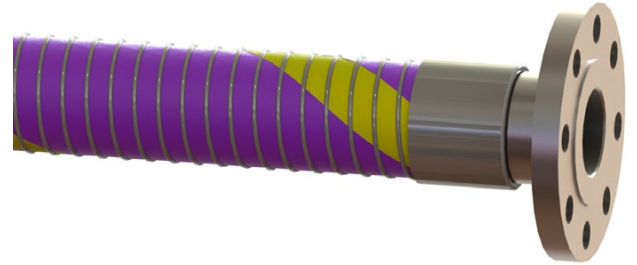

Applicable Standards

EN 13765:2010 TYPE 3, EN ISO 1746

Specifications

Part Number	Nominal Dia.		Max. Working Pressure		Max. Burst Pressure		Min. Bend Radius	Weight Per Mtr
	Inches	I.D (mm)	kPa	psi	kPa	psi	mm	kg.
CH-PTFE900HD-20	3/4"	20	2000	300	10000	1500	75	0.63
CH-PTFE900HD-25	1"	25	2000	300	10000	1500	100	0.77
CH-PTFE900HD-32	1 1/4"	32	2000	300	10000	1500	125	1.05
CH-PTFE900HD-40	1 1/2"	40	2000	300	10000	1500	140	1.33
CH-PTFE900HD-50	2"	50	2000	300	10000	1500	180	2.04
CH-PTFE900HD-65	2 1/2"	65	2000	300	10000	1500	220	2.75
CH-PTFE900HD-80	3"	75	2000	300	10000	1500	180	3.15
CH-PTFE900HD-100	4"	100	2000	300	10000	1500	400	4.74
CH-PTFE900HD-150	6"	150	2000	300	10000	1500	574	10.00
CH-PTFE900HD-200	8"	200	2000	300	10000	1500	800	12.85
CH-PTFE900HD-250	10"	250	2000	300	10000	1500	1000	20.85
CH-PTFE900HD-300	12"	300	2000	300	10000	1500	1200	31.69

Safety Factor: 5:1 Standard Duty. (Burst Pressure: Working Pressure)

Applications



Composite Hose - Chemical

Composite Hose - 300SD PTFE

Part No.: CH-PTFE300SD

Colour: Red / Yellow Stripe

Inner Wire: 316 Stainless Steel

Lining: ECTFE films

Cover: Polyvinyl coated polyester fabric cover

Reinforcement: Polyethylene films

Outer Wire: 316 Stainless Steel

Crimping: Swagged or Wire Whipped

Size Available: 1 1/2" - 8"

Temperature: -40°C +125°C

Low | Med | High

Flexibility

Cycle Life

Pressure Rating

Chemical Resistance

Wall Thickness

Construction

Use:

General purpose Standard Duty hose suitable for the safe transfer of a wide variety of Chemicals under suction or pressure where the chemical resistance of polypropylene is inadequate. Commonly used for loading and unloading of road and rail tankers, storage tank and in-plant applications.

Applicable Standards

EN 13765:2010, AS2682, AS2117

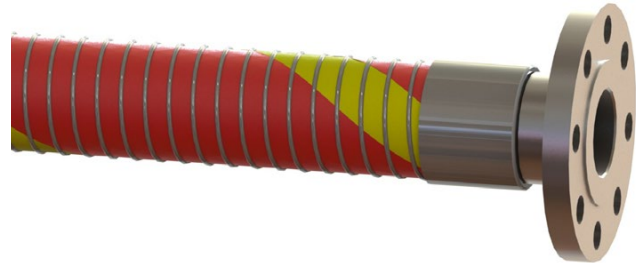

Specifications

Part Number	Nominal Dia.		Max. Working Pressure		Max. Burst Pressure		Min. Bend Radius	Weight Per Mtr
	Inches	I.D (mm)	kPa	psi	kPa	psi	mm	kg.
CH-PTFE300SD-40	1 1/2"	40	1400	200	7000	1015	140	1.33
CH-PTFE300SD-50	2"	50	1400	200	7000	1015	180	2.04
CH-PTFE300SD-65	2 1/2"	65	1400	200	7000	1015	220	2.75
CH-PTFE300SD-80	3"	75	1400	200	7000	1015	180	3.15
CH-PTFE300SD-100	4"	100	1400	200	7000	1015	400	4.74
CH-PTFE300SD-150	6"	150	1400	200	7000	1015	574	10.00
CH-PTFE300SD-200	8"	200	1400	200	7000	1015	800	12.85

Safety Factor: 5:1 Standard Duty. (Burst Pressure: Working Pressure)

Applications



Composite Hose - Chemical

Composite Hose - Code 300HD PTFE

Part No.: CH-PTFE300HD
Colour: Red / Yellow Stripe
Inner Wire: 316 Stainless Steel
Lining: FEP tubular extruded film
Cover: Thermoplastic films
Reinforcement: Thermoplastic films
Outer Wire: 316 Stainless Steel
Crimping: Swagged or Wire Whipped
Size Available: 3/4" - 12"
Temperature: -40°C +125°C

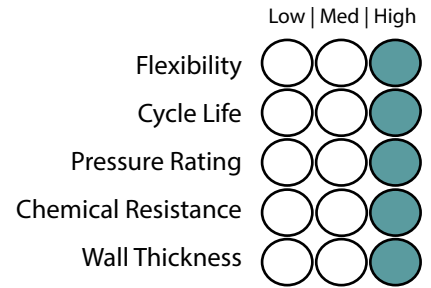

Construction

Use:

Heavy Duty construction for aggressive chemicals Suction & Delivery. Used for Ship to Shore and Ship to Ship, Dock side and in general for the most arduous Industrial and Marine applications.

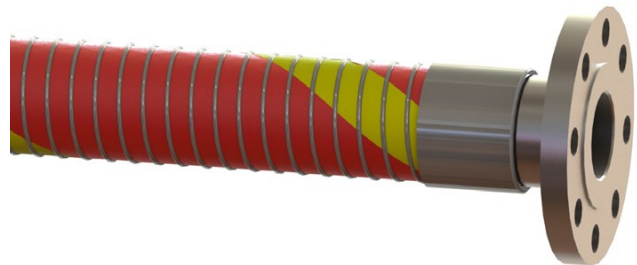

Applicable Standards

EN 13765:2010, AS2682, AS2117

Specifications

Part Number	Nominal Dia.		Max. Working Pressure		Max. Burst Pressure		Min. Bend Radius	Weight Per Mtr
	Inches	I.D (mm)	kPa	psi	kPa	psi	mm	kg.
CH-PTFE300HD-20	3/4"	20	1400	200	7000	1015	75	0.63
CH-PTFE300HD-25	1"	25	1400	200	7000	1015	100	0.77
CH-PTFE300HD-32	1 1/4"	32	1400	200	7000	1015	125	1.05
CH-PTFE300HD-40	1 1/2"	38	1400	200	7000	1015	140	1.33
CH-PTFE300HD-50	2"	50	1400	200	7000	1015	180	2.04
CH-PTFE300HD-65	2 1/2"	65	1400	200	7000	1015	220	2.75
CH-PTFE300HD-80	3"	80	1400	200	7000	1015	280	3.15
CH-PTFE300HD-100	4"	100	1400	200	7000	1015	400	4.74
CH-PTFE300HD-150	6"	150	1400	200	7000	1015	550	10.50
CH-PTFE300HD-200	8"	200	1400	200	7000	1015	800	12.85
CH-PTFE300HD-250	10"	250	1400	200	7000	1015	1000	20.96
CH-PTFE300HD-300	12"	300	1400	200	7000	1015	1200	31.69

Safety Factor: 5:1 Standard Duty. (Burst Pressure: Working Pressure)

Applications



Composite Hose - Chemical

Composite Hose - ECTFE

Part No.: CH-ECTFE

Colour: Blue / White Stripe

Inner Wire: 316 Stainless Steel

Lining: ECTFE

Cover: PVC Coated Polyester Cloth

Reinforcement: Polyester Fabrics

Outer Wire: 316 Stainless Steel

Crimping: Swagged or Wire Whipped

Size Available: 4" - 10"

Temperature: -30°C +80°C

Type: 2/3

Grade: 2

Electrical kind: B - Discontinuous

Low | Med | High

Flexibility

Cycle Life

Pressure Rating

Chemical Resistance

Wall Thickness

Construction

Use:

Designed for suction and discharge of the most aggressive chemicals and searching solvents and is generally used where the chemical resistance of polypropylene is inadequate.

This hose is extremely robust and is used predominantly for ship to shore/ship to ship operations, and for the most demanding of plant duties. It can be used for the transfer of certain liquid food products.

Applicable Standards

BSEN13765:2010



Specifications

Part Number	Nominal Dia.			Max. Working Pressure		Max. Burst Pressure		Min. Bend Radius	Weight Per Mtr
	Inches	I.D (mm)	O.D (mm)	kPa	psi	kPa	psi	mm	kg.
CH-ECTFE-100	4"	100	112	200	29	1000	145	6.4	0.9
CH-ECTFE-150	6"	150	180	200	29	1000	145	10.7	0.9
CH-ECTFE-200	8"	200	222	200	29	1000	145	15.0	0.9
CH-ECTFE-250	10"	250	285	150	21	750	108	20.5	0.9

Safety Factor: 5:1 Standard Duty. (Burst Pressure: Working Pressure)

Applications



Composite Hose - Bitumen

Composite Hose - 966 Hot Bitumen

Part No.: CH-966
Colour: Standard White
Inner Wire: Galvanised Steel
Reinforcement: Polypropylene Fabric and Films
Outer Wire: Stainless Steel
Crimping: Swagged or Wire Whipped
Size Available: 3/4" - 3"
(Larger sizes upon Request)
Temperature: -20°C +180°C

Type: 1
Grade: 3
Electrical kind: 1

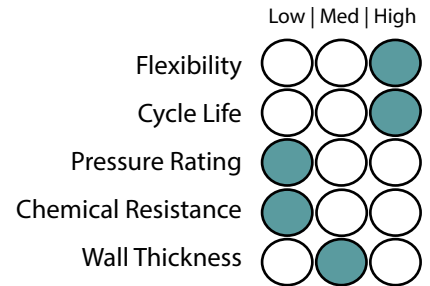

Construction

Use:

Designed for high temperature operation, this hose is ideal for the transfer of hot bitumen via gravity, suction or pressure. Suitable for use with bitumen up to 180°C. Suited for road tanker loading and discharge, in plant transfer, spraying and spray bar applications also suitable for conveying high aromatic content fuels.

- This hose is not recommended for use close to direct external radiant heat as the cover is not flame retardant.
- Hoses should be flushed with diesel or kerosene after use. Cleaning with steam or direct external heat is not recommended.



Applicable Standards

AS2117

Specifications

Part Number	Nominal Dia.			Max. Working Pressure		Max. Burst Pressure		Min. Bend Radius	Weight Per Mtr
	Inches	I.D (mm)	O.D (mm)	kPa	psi	kPa	psi	mm	kg.
CH-966-20	3/4"	19	28	700	101	2800	406	125	0.8
CH-966-25	1"	25	35	700	101	2800	406	125	0.9
CH-966-32	1 1/4"	32	43	700	101	2800	406	130	1.0
CH-966-40	1 1/2"	39	50	700	101	2800	406	150	1.5
CH-966-50	2"	51	68	600	87	2400	348	200	2.0
CH-966-65	2 1/2"	63	78	500	72	2000	290	250	2.8
CH-966-80	3"	76	90	500	72	2000	290	280	3.5

Alternative products:

- Refer to HYTAR Bitumen Fittings - Page 248
- Refer to Bitumen Stainless Steel Hose - Page 48
- Refer to Spray Bar specification - Page 39

Safety Factor: 4:1 Standard Duty. (Burst Pressure: Working Pressure)

Applications



Composite Hose - Aviation

Composite Hose - 700 Aviation

Part No.: CH-AVA
Colour: Black / Green Stripe
Inner Wire: Stainless Steel
Reinforcement: Polypropylene Fabric and Films
Outer Wire: Black polypropylene coated galvanised
Crimping: Swagged or Wire Whipped
Size Available: 1 1/2" - 4"
(Larger sizes upon Request)
Temperature: -20°C +80°C

Type: 2
Grade: 1
Electrical kind: 1

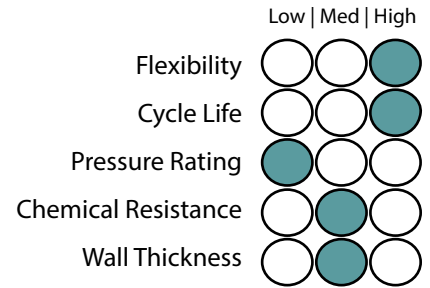

Construction

Use:
 This range of high quality composite hoses is manufactured from multiple layers of polypropylene fabrics and films. The inner wire helix is stainless steel 316. AVA SG is the same design as CODE 969, but has a thinner wall thickness therefore the working pressure is decreased. AVA SG is designed for use as a delivery hose of aviation fuel.

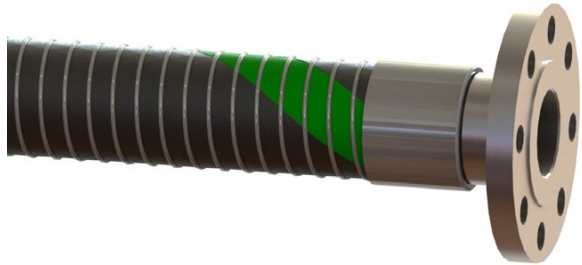

Applicable Standards
 AS2683

Specifications

Part Number	Nominal Dia.			Max. Working Pressure		Max. Burst Pressure		Min. Bend Radius	Weight Per Mtr
	Inches	I.D (mm)	O.D (mm)	kPa	psi	kPa	psi	mm	kg.
CH-AVA-40	1 1/2"	39	48	700	101	2800	406	75	1.3
CH-AVA-50	2"	51	63	600	87	2400	348	90	1.6
CH-AVA-80	3"	76	90	500	72	2000	290	125	2.8
CH-AVA-100	4"	102	112	400	58	1600	232	200	4.1

Safety Factor: 4:1 Standard Duty. (Burst Pressure: Working Pressure)

Applications



Composite Hose - Fire Resistant

Composite Hose - FireSafe

Part No.: CH-FIRESAFE
Colour: Red / White Stripe
Inner Wire: Galvanised Steel
Reinforcement: Polypropylene Fabric and Films
Outer Wire: Galvanised Steel
Crimping: Swagged or Wire Whipped
Size Available: 1" - 4"
(Larger sizes upon Request)
Temperature: -20°C +80°C

Low | Med | High

Flexibility

Cycle Life

Pressure Rating

Chemical Resistance

Wall Thickness

Construction

Use:

FIRESAFE composite hose utilizes a series of non asbestos barriers to conduct and radiate heat to achieve outstanding fire retardant ability. Rigorous testing by an independent agency has proven FIRESAFE hose still intact and capable of holding product after thirty (30) minutes of severe fire attack. The internal versus external temperature during this test showed an extremely low heat transfer rate maintaining an internal temperature of below 200 degrees Celsius with an external temperature over 800 degrees Celsius. Even after loss of integrity, FIRESAFE hose will not fail catastrophically.

These characteristics coupled with better torque resistance and abrasion resistance compared to metallic flexible hose, make this a viable alternative for bottom loading/ drop hoses.

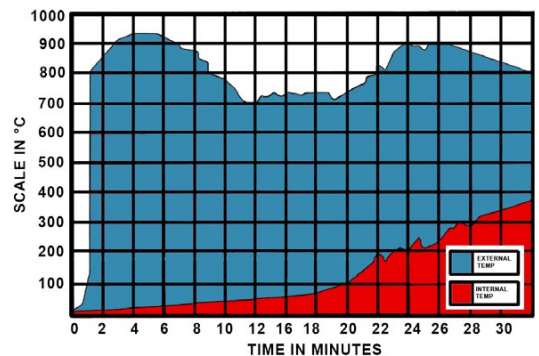
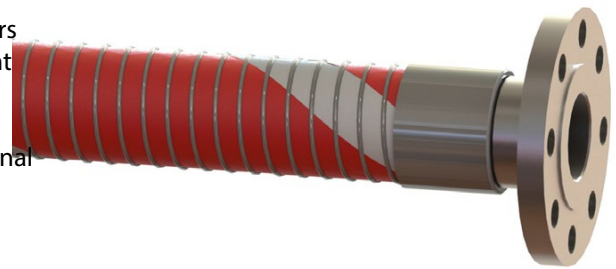

Applicable Standards

BSEN13765:2010
 Approved and Tested by:
 British Government Department of the Environment
 British Fire Research Station
 Swedish Fire Service

Specifications

Part Number	Nominal Dia.		Max. Working Pressure		Max. Burst Pressure		Min. Bend Radius	Weight Per Mtr
	Inches	I.D (mm)	kPa	psi	kPa	psi	mm	kg.
CH-FIRESAFE-25	1"	25	1400	203	5600	812	100	0.8
CH-FIRESAFE-40	1 1/2"	38	1400	203	5600	812	140	1.2
CH-FIRESAFE-50	2"	50	1400	203	5600	812	180	1.9
CH-FIRESAFE-75	3"	75	1400	203	5600	812	280	2.5
CH-FIRESAFE-100	4"	100	1400	203	5600	812	395	5.2

Safety Factor: 4:1 Standard Duty. (Burst Pressure: Working Pressure)

Applications



Composite Hose - Cryogenic

Composite Hose - Cryogenic

Part No.: CRY
Colour: Standard White
Inner Wire: 316 Stainless Steel
Reinforcement: Polyamide Polyester
Outer Wire: 316 Stainless Steel
Crimping: Swagged or Wire Whipped
Size Available: 1" - 10"
Temperature: -200°C +80°C

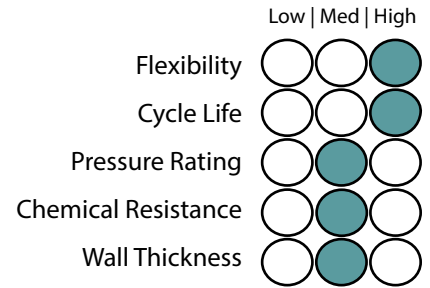

Construction

Use:
 With excellent resistance to the low temperatures required for transfer of liquid gases such as Liquefied Petroleum Gas (LPG), Liquefied Natural Gas (LNG), carbon dioxide, ammonia or ethylene. While specifically designed for cryogenic fluids, the hose is also suitable for use with a wide range of hazardous chemicals.



Applicable Standards

EN13766:2010 Exceeds Class A
 IMO IGC code
 AS/NZ 1869
 BSEN13766:2010

Specifications

Part Number	Nominal Dia.		Max. Working Pressure		Max. Burst Pressure		Min. Bend Radius	Weight Per Mtr
	Inches	I.D (mm)	kPa	psi	kPa	psi	mm	kg.
CH-CRY-25	1"	25	2500	360	12500	1812	100	1.0
CH-CRY-40	1 1/2"	38	2500	360	12500	1812	140	1.5
CH-CRY-50	2"	50	2500	360	12500	1812	180	2.5
CH-CRY-65	2 1/2"	65	2500	360	12500	1812	205	3.3
CH-CRY-80	3"	75	2500	360	12500	1812	280	4.5
CH-CRY-100	4"	100	2500	360	12500	1812	395	7.5
CH-CRY-150	6"	150	2500	360	12500	1812	510	13.5
CH-CRY-200	8"	200	2040	295	10200	1450	760	18.5
CH-CRY-250	10"	250	1500	217	7500	1090	915	25

Safety Factor 5:1 Standard Duty. (Burst Pressure: Working Pressure)

Applications



Composite Hose - Cryogenic

Composite Hose - LPG

Part No.: LPG
Colour: White / Yellow Stripe
Inner Wire: 316 Stainless Steel
Lining: Polypropilene films
Cover: Polyester Fabrics
Reinforcement: Polyester Fabrics
Outer Wire: 316 Stainless Steel
Crimping: Swagged or Wire Whipped
Size Available: 3/4" - 12"
Temperature: -105°C +100°C

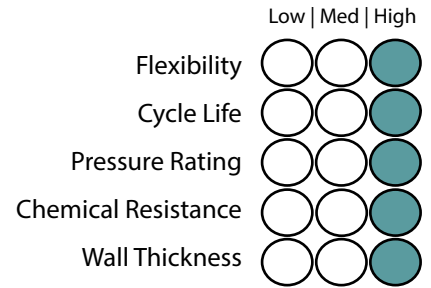

Construction

Use:

Suitable for transferring fully refrigerated conveyants such as LPG, Propane and Buthane down to -105°C, as well as liquid Ethane at and liquid Ethylene. Suitable for fluids included in Chap XIX, Gas carrier Code.



Applicable Standards

EN ISO 8031:2009 – 4.7, EN ISO 1402, DNV

Specifications

Part Number	Nominal Dia.		Max. Working Pressure		Max. Burst Pressure		Min. Bend Radius	Weight Per Mtr
	Inches	I.D (mm)	kPa	psi	kPa	psi	mm	kg.
CH-LPG-20	3/4"	20	2500	362	12500	1813	80	0.8
CH-LPG-25	1"	25	2500	362	12500	1813	100	1.0
CH-LPG-32	1 1/4"	32	2500	362	12500	1813	125	1.3
CH-LPG-40	1 1/2"	40	2500	362	12500	1813	140	1.5
CH-LPG-50	2"	50	2500	362	12500	1813	180	2.5
CH-LPG-65	2 1/2"	65	2500	362	12500	1813	200	3.3
CH-LPG-80	3"	75	2500	362	12500	1813	260	4.0
CH-LPG-100	4"	100	2500	362	12500	1813	350	5.3
CH-LPG-150	6"	150	2500	362	12500	1813	500	13.2
CH-LPG-200	8"	200	2500	362	12500	1813	750	18.0
CH-LPG-250	10"	250	1500	218	7500	1087	900	25.0
CH-LPG-300	12"	300	1000	145	5000	725	1500	34.0

Safety Factor: 5:1 Standard Duty. (Burst Pressure: Working Pressure)

Applications



Composite Hose - Cryogenic

Composite Hose - LNG

Part No.: IH-LNG
Colour: White / Yellow Stripe
Inner Wire: 316 Stainless Steel
Lining: Polypropilene films
Cover: Polyester Fabrics
Reinforcement: Polyester Fabrics
Outer Wire: 316 Stainless Steel
Crimping: Swagged or Wire Whipped
Size Available: 3/4" - 12"
Temperature: -200°C +80°C

	Low Med High
Flexibility	○ ○ ●
Cycle Life	○ ○ ●
Pressure Rating	○ ○ ●
Chemical Resistance	○ ○ ●
Wall Thickness	○ ○ ●

Construction

Use:

Hose is suitable for handling LNG Liquefied Natural Gas, Liquid Methane and liquid Nitrogen at -200°C. Liquefied Natural Gas LNG at extremely low temperatures

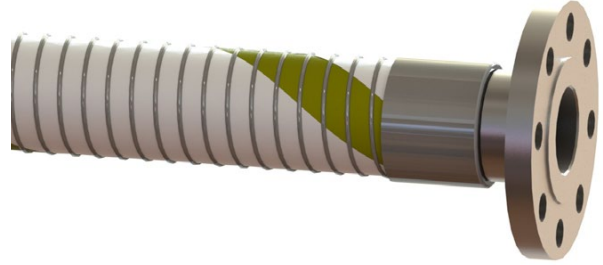

Applicable Standards:

EN ISO 8031:2009 – 4.7, EN ISO 1402, DNV

Specifications

Part Number	Nominal Dia.		Max. Working Pressure		Max. Burst Pressure		Min. Bend Radius	Weight Per Mtr
	Inches	I.D (mm)	kPa	psi	kPa	psi	mm	kg.
IH-LNG-20	3/4"	20	1380	200	11040	1600	80	0.8
IH-LNG-25	1"	25	1380	200	11040	1600	100	1.0
IH-LNG-32	1 1/4"	32	1380	200	11040	1600	125	1.3
IH-LNG-40	1 1/2"	40	1380	200	11040	1600	140	1.5
IH-LNG-50	2"	50	1380	200	11040	1600	180	2.5
IH-LNG-65	2 1/2"	65	1380	200	11040	1600	200	3.3
IH-LNG-80	3"	75	1380	200	11040	1600	260	4.0
IH-LNG-100	4"	100	1275	184	10200	1479	350	5.3
IH-LNG-150	6"	150	1275	184	10200	1479	500	13.2
IH-LNG-200	8"	200	1275	184	10200	1479	750	18.0
IH-LNG-250	10"	250	1275	184	10200	1479	900	25.0
IH-LNG-300	12"	300	1030	149	8240	1195	1500	34.0

Safety Factor: 8:1 Standard Duty. (Burst Pressure: Working Pressure)

Applications



Composite Hose - Industrial

Composite Jacketed Hose

A jacketed assembly consists of a "hose within a hose." An inner or primary media conveying hose is enclosed or jacketed by a larger diameter hose. The hoses are joined at each end by specially designed fittings so that there is no media pathway between the two hoses.

Jacketed assemblies are often specified when the primary media must be kept at either an elevated or cryogenic temperature. Steam is often circulated through the jacket hose to keep a viscous material in the inner hose hot and easily conveyed. A vacuum can also be pulled on the jacket hose to insulate cryogenic liquids being conveyed in the inner hose.

The media typically is steam, hot oil or hot water to raise the temperature of the fluid moved in the internal hose. Also cold products such as liquid helium or nitrogen can be used to lower the temperature of the fluid with-in the internal hose.

The specialist hose design can also be used to contain hazardous and chemical mediums in the event of a rupture. The outer hose will capture any medium that leaks from the inner hose preventing any safety or environmental issues. Sensors can be installed on the ports of the outer hoses to analyse any changes in pressure or gas detection.

Following Applications:

- Rail car and tank truck loading/unloading
- Marine Transfer
- Flexible connections to vibrating equipment
- To relieve pump housing stresses
- Hazardous material piping system using an alarmed vacuum jacket
- Safety barrier for toxic processes
- Leak detection systems
- Liquefied food transfer systems

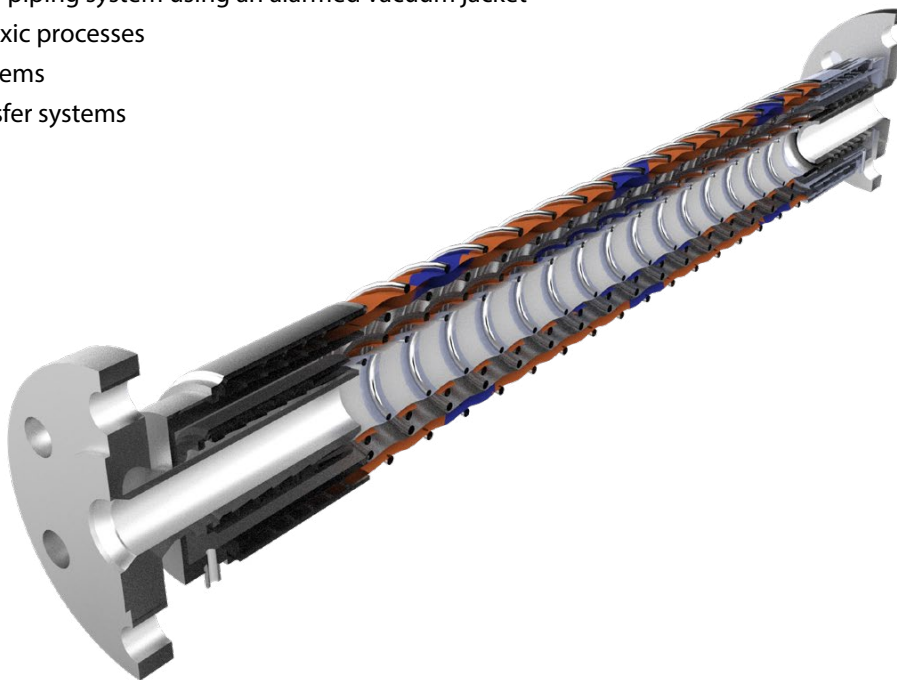

Inner hose nb size	25mm	32mm	38mm	50mm	65mm	75mm	100mm	125mm	150mm
Outer hose nb size	50mm	65mm	65mm	75mm	100mm	100mm	150mm	150mm	200mm
Inner hose max pressure (kPa)	1000	1000	1000	1000	1000	1000	1000	1000	1000



05

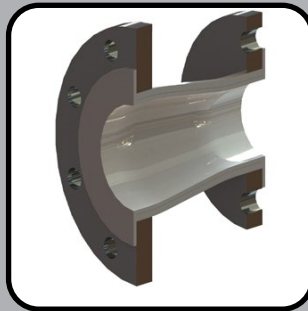

PIPING SYSTEMS / LINED

The Range

LINED SPOOL

Size : 1" to 12"

Profile : Smoothbore

Working Pressure : 1720 to 3160 kPa

Page 194



LINED 90° ELBOW

Size : 1" to 12"

Profile : Smoothbore

Working Pressure : 1720 to 3160 kPa

Page 195



LINED 90° 3D ELBOW

Size : 1" to 12"

Profile : Smoothbore

Working Pressure : 1720 to 3160 kPa

Page 190



LINED 45° ELBOW

Size : 1" to 12"

Profile : Smoothbore

Working Pressure : 1720 to 3160 kPa

Page 197



LINED 45° 3D ELBOW

Size : 1" to 12"

Profile : Smoothbore

Working Pressure : 1720 to 3160 kPa

Page 198



LINED TEE

Size : 1" to 12"

Profile : Smoothbore

Working Pressure : 1720 to 3160 kPa

Page 199



LINED CROSS

Size : 1" to 12"

Profile : Smoothbore

Working Pressure : 1720 to 3160 kPa

Page 200



LINED CONCENTRIC REDUCER

Size : 1" to 12"

Profile : Smoothbore

Working Pressure : 1720 to 3160 kPa

Page 201

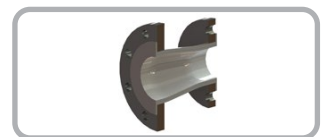

LINED ECCENTRIC REDUCER

Size : 1" to 12"

Profile : Smoothbore

Working Pressure : 1720 to 3160 kPa

Page 202

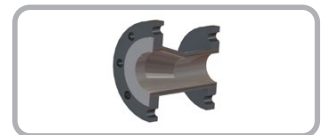

PIPING SYSTEMS

Size : 1" to 14"

Profile : Smoothbore

Page 203



Lined Piping Systems - Spool

Lined Spool

Construction: Smoothbore

Pipe: Carbon Steel / Stainless Steel
(Other specialty metals on request)

Liner: PTFE, PFA, PVDF, PP, FEP, ETFE

Size Available: 1" - 12"
(Larger sizes upon Request)

Vacuum: Full Vacuum

Temperature: -30°C to 260°C

Low | Med | High

Flexibility

Cycle Life

Pressure Rating

Chemical Resistance

Wall Thickness

Construction

Use:

Our range of products are used in various industries such as Chemicals, Refineries, Pesticides, Petrochemicals, Steel, Food-Processing, Beverages, Alcohols and Acids, Pharmaceuticals, Circuit Breakers, Fertilizers, Desalination.



Standards:

ASTM F1545, AS4041 Class 1, ASME IX

Specifications

Part No:	Size	Internal Diameter	Liner Thickness	Flared Dia	At temp(°C)	ANSI class 150	ANSI class 300
	inch	mm	mm	mm	°C	kpa	kpa
TLPa-25-AF3-AF4-b-c	1"	19.50	3.05	50.80	40	1760	3160
TLPa-38-AF3-AF4-b-c	1 1/2"	33.80	3.30	73.00	100	1650	2740
TLPa-50-AF3-AF4-b-c	2"	45.40	3.30	92.10	150	1510	2430
TLPa-80-AF3-AF4-b-c	3"	70.80	3.30	127.00	200	1400	2080
TLPa-100-AF3-AF4-b-c	4"	95.20	3.80	157.20	250	1200	1720
TLPa-150-AF3-AF4-b-c	6"	145.10	4.50	215.90			
TLPa-200-AF3-AF4-b-c	8"	197.40	5.00	269.90			
TLPa-250-AF3-AF4-b-c	10"	249.30	6.00	323.90			
TLPa-300-AF3-AF4-b-c	12"	300.10	6.00	381.00			

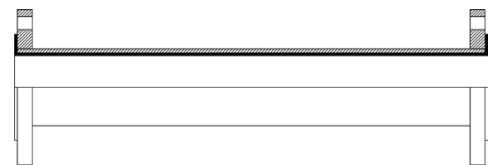

Part Number Key:

a = Pipe Material

6S = 316 Stainless Steel | 4S = 304 Stainless Steel | MS = Carbon Steel

b = 316 Stainless Steel Flange Type

A1 = ANSI 150lb | TE = Table E | TD = Table D | D16 = DIN 16

c = Face to Face Length (mm)

Applications



PIPING SYSTEMS / LINED

Lined Piping Systems - 90° Elbow

Lined 90° Elbow

Construction : Smoothbore

Pipe : Carbon Steel / Stainless Steel
(Other specialty metals on request)

Liner: PTFE, PFA, PVDF, PP, FEP, ETFE

Size Available : 1" - 12" (Larger sizes upon Request)

Vacuum : Full Vacuum

Temperature : -30°C to 260°C

	Low Med High
Flexibility	● ○ ○
Cycle Life	○ ○ ●
Pressure Rating	○ ○ ●
Chemical Resistance	○ ○ ●
Wall Thickness	○ ○ ●

Construction

Use:

Our range of products are used in various industries such as Chemicals, Refineries, Pesticides, Petrochemicals, Steel, Food-Processing, Beverages, Alcohols and Acids, Pharmaceuticals, Circuit Breakers, Fertilizers, Desalination.



Standards:

ASTM F1545, AS4041:2006 Class 1, ASME IX:2010

Specifications

Part Number:	Size	Face to Centre (X)	Liner Thickness	Flared Dia
	inch	mm	mm	mm
TLP90a-25 -AF3-AF3-b	1"	89	3.50	51
TLP90a-38 -AF3-AF3-b	1 1/2"	102	3.50	73
TLP90a-50 -AF3-AF3-b	2"	114	4.30	92
TLP90a-80 -AF3-AF3-b	3"	140	4.40	127
TLP90a-100 -AF3-AF3-b	4"	165	4.40	157
TLP90a-150 -AF3-AF3-b	6"	203	5.50	216
TLP90a-200 -AF3-AF3-b	8"	229	6.00	270
TLP90a-250 -AF3-AF3-b	10"	279	7.50	324
TLP90a-300 -AF3-AF3-b	12"	235	7.50	381

At temp(°C)	ANSI class 150	ANSI class 300
°C	kpa	kpa
40	1760	3160
100	1650	2740
150	1510	2430
200	1400	2080
250	1200	1720

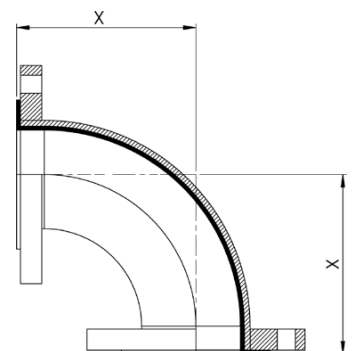

Part Number Key:

a = Pipe Material

6S = 316 Stainless Steel | 4S = 304 Stainless Steel | MS = Carbon Steel

b = 316 Stainless Steel Flange Type

A1 = ANSI 150lb | TE = Table E | TD = Table D | D16 = DIN 16

Applications





RUBBER & COMPOSITE HOSE

Lined Piping Systems - 90° 3D Elbow

Lined 90° 3D Elbow

Construction : Smoothbore
Pipe : Carbon Steel / Stainless Steel
(Other specialty metals on request)
Liner: PTFE, PFA, PVDF, PP, FEP, ETFE
Size Available : 1" - 12"
(Larger sizes upon Request)
Vacuum : Full Vacuum
Temperature : -30°C to 260°C

	Low	Med	High
Flexibility	●	○	○
Cycle Life	○	○	●
Pressure Rating	○	○	●
Chemical Resistance	○	○	●
Wall Thickness	○	○	●

Construction

Use:
 Our range of products are used in various industries such as Chemicals, Refineries, Pesticides, Petrochemicals, Steel, Food-Processing, Beverages, Alcohols and Acids, Pharmaceuticals, Circuit Breakers, Fertilizers, Desalination.



Standards:
 ASTM F1545, AS4041:2006 Class 1, ASME IX:2010

Specifications

Part Number:	Size	Face to Centre (X)	Internal Diameter	Liner Thickness	Flared Dia
	inch	mm	mm	mm	mm
3DTLP90a-25 -AF3-AF3-b	1"	279	19.50	3.05	50.80
3DTLP90a-38 -AF3-AF3-b	1 1/2"	330	33.80	3.30	73.00
3DTLP90a-50 -AF3-AF3-b	2"	381	45.40	3.30	92.10
3DTLP90a-80 -AF3-AF3-b	3"	533	70.80	3.30	127.00
3DTLP90a-100 -AF3-AF3-b	4"	660	95.20	3.80	157.20

At temp(°C)	ANSI class 150	ANSI class 300
°C	kpa	kpa
40	1760	3160
100	1650	2740
150	1510	2430
200	1400	2080
250	1200	1720

Part Number Key:
a = Pipe Material
 6S = 316 Stainless Steel | 4S = 304 Stainless Steel | MS = Carbon Steel
b = 316 Stainless Steel Flange Type
 A1 = ANSI 150lb | TE = Table E | TD = Table D | D16 = DIN 16

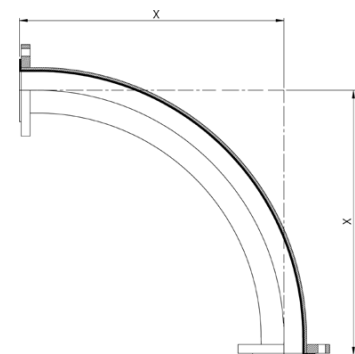

Applications



Lined Piping Systems - 45° Elbow

Lined 45° Elbow

Construction : Smoothbore

Pipe : Carbon Steel / Stainless Steel (Other specialty metals on request)

Liner: PTFE, PFA, PVDF, PP, FEP, ETFE

Size Available : 1" - 12" (Larger sizes upon Request)

Vacuum : Full Vacuum

Temperature : -30°C to 260°C

	Low	Med	High
Flexibility	●	○	○
Cycle Life	○	○	●
Pressure Rating	○	○	●
Chemical Resistance	○	○	●
Wall Thickness	○	○	●

Construction

Use:

Our range of products are used in various industries such as Chemicals, Refineries, Pesticides, Petrochemicals, Steel, Food-Processing, Beverages, Alcohols and Acids, Pharmaceuticals, Circuit Breakers, Fertilizers, Desalination.



Standards:

ASTM F1545, AS4041:2006 Class 1, ASME IX:2010

Specifications

Part Number:	Size	Face to Centre (X)	Liner Thickness	Flared Dia
	inch	mm	mm	mm
TLP45a-25 -AF3-AF3-b	1"	44	3.50	51
TLP45a-38 -AF3-AF3-b	1 1/2"	57	3.50	73
TLP45a-50 -AF3-AF3-b	2"	63	4.30	92
TLP45a-80 -AF3-AF3-b	3"	76	4.40	127
TLP45a-100 -AF3-AF3-b	4"	102	4.40	157
TLP45a-150 -AF3-AF3-b	6"	127	5.50	216
TLP45a-200 -AF3-AF3-b	8"	140	6.00	270
TLP45a-250 -AF3-AF3-b	10"	165	7.50	324
TLP45a-300 -AF3-AF3-b	12"	190	7.50	381

At temp(°C)	ANSI class 150	ANSI class 300
°C	kpa	kpa
40	1760	3160
100	1650	2740
150	1510	2430
200	1400	2080
250	1200	1720

Part Number Key:

a = Pipe Material

6S = 316 Stainless Steel | 4S = 304 Stainless Steel | MS = Carbon Steel

b = 316 Stainless Steel Flange Type

A1 = ANSI 150lb | TE = Table E | TD = Table D | D16 = DIN 16

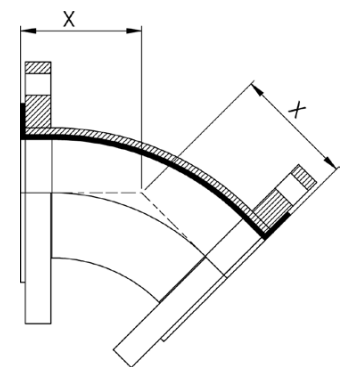

Applications



PIPING SYSTEMS / LINED



RUBBER & COMPOSITE HOSE

Lined Piping Systems - 45° 3D Elbow

Lined 45° 3D Elbow

Construction : Smoothbore

Pipe : Carbon Steel / Stainless Steel (Other specialty metals on request)

Liner: PTFE, PFA, PVDF, PP, FEP, ETFE

Size Available : 1" - 12" (Larger sizes upon Request)

Vacuum : Full Vacuum

Temperature : -30°C to 260°C

Low | Med | High

Flexibility

Cycle Life

Pressure Rating

Chemical Resistance

Wall Thickness

Construction

Use:

Our range of products are used in various industries such as Chemicals, Refineries, Pesticides, Petrochemicals, Steel, Food-Processing, Beverages, Alcohols and Acids, Pharmaceuticals, Circuit Breakers, Fertilizers, Desalination.



Standards:

ASTM F1545, AS4041:2006 Class 1, ASME IX:2010

Specifications

Part Number:	Size	Face to Centre (X)	Internal Diameter	Liner Thickness	Flared Dia
	inch	mm	mm	mm	mm
3DTLP45a-25 -AF3-AF3-b	1"	203	19.50	3.05	50.80
3DTLP45a-38 -AF3-AF3-b	1 1/2"	229	33.80	3.30	73.00
3DTLP45a-50 -AF3-AF3-b	2"	254	45.40	3.30	92.10
3DTLP45a-80 -AF3-AF3-b	3"	330	70.80	3.30	127.00
3DTLP45a-100-AF3-AF3-b	4"	432	95.20	3.80	157.20

At temp(°C)	ANSI class 150	ANSI class 300
°C	kpa	kpa
40	1760	3160
100	1650	2740
150	1510	2430
200	1400	2080
250	1200	1720

Part Number Key:

a = Pipe Material

6S = 316 Stainless Steel | 4S = 304 Stainless Steel | MS = Carbon Steel

b = 316 Stainless Steel Flange Type

A1 = ANSI 150lb | TE = Table E | TD = Table D | D16 = DIN 16

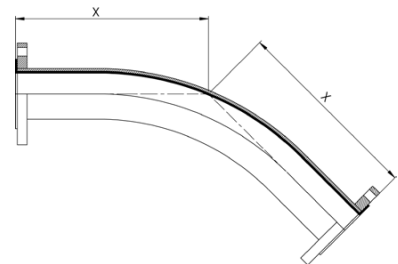

Applications



9
8
7
6
5
4
3
2
1
PIPING SYSTEMS / LINED

Lined Piping Systems - Tee

Lined Tee

Construction : Smoothbore
Pipe : Carbon Steel / Stainless Steel (Other specialty metals on request)
Liner: PTFE, PFA, PVDF, PP, FEP, ETFE
Size Available : 1" - 12" (Larger sizes upon Request)
Vacuum : Full Vacuum
Temperature : -30°C to 260°C

	Low Med High
Flexibility	<input type="radio"/> <input type="radio"/> <input type="radio"/>
Cycle Life	<input type="radio"/> <input type="radio"/> <input type="radio"/>
Pressure Rating	<input type="radio"/> <input type="radio"/> <input type="radio"/>
Chemical Resistance	<input type="radio"/> <input type="radio"/> <input type="radio"/>
Wall Thickness	<input type="radio"/> <input type="radio"/> <input type="radio"/>

Construction

Use:

Our range of products are used in various industries such as Chemicals, Refineries, Pesticides, Petrochemicals, Steel, Food-Processing, Beverages, Alcohols and Acids, Pharmaceuticals, Circuit Breakers, Fertilizers, Desalination.

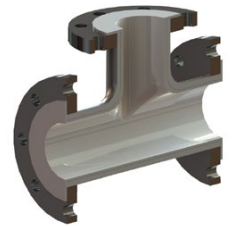

Standards:

ASTM F1545, AS4041:2006 Class 1, ASME IX:2010

Specifications

Part Number:	Size		Face to Centre (X)
	NB1	NB2	mm
TLPTa-25-25-AF3-AF3-b	1"	1"	89
TLPTa-38-38-25-AF3-AF3-b	1 1/2"	1"	102
TLPTa-38-38-AF3-AF3-b	1 1/2"	1 1/2"	102
TLPTa-50-50-AF3-AF3-b	2"	1"	114
TLPTa-50-50-38-AF3-AF3-b	2"	1 1/2"	114
TLPTa-50-50-AF3-AF3-b	2"	2"	114
TLPTa-80-80-38-AF3-AF3-b	3"	1 1/2"	140
TLPTa-80-80-50-AF3-AF3-b	3"	2"	140
TLPTa-80-80-AF3-AF3-b	3"	3"	140
TLPTa-100-100-50-AF3-AF3-b	4"	2"	165
TLPTa-100-100-80-AF3-AF3-b	4"	3"	165
TLPTa-100-100-AF3-AF3-b	4"	4"	165
TLPTa-150-150-80-AF3-AF3-b	6"	3"	203
TLPTa-150-150-100-AF3-AF3-b	6"	4"	203
TLPTa-150-150-AF3-AF3-b	6"	6"	203
TLPTa-200-200-AF3-AF3-b	8"	8"	229

At temp(°C)	ANSI class 150	ANSI class 300
°C	kpa	kpa
40	1760	3160
100	1650	2740
150	1510	2430
200	1400	2080
250	1200	1720

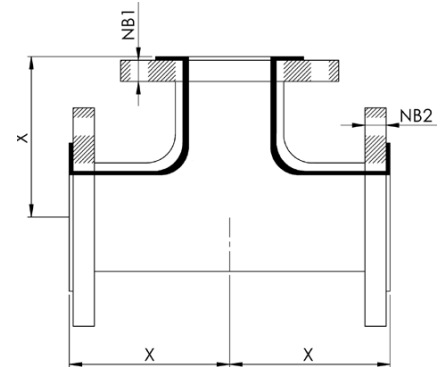

Part Number Key:

a = Pipe Material: 6S = 316 Stainless Steel | 4S = 304 Stainless Steel | MS = Carbon Steel
b = 316 Stainless Steel Flange Type: A1 = ANSI 150lb | TE = Table E | TD = Table D | D16 = DIN 16

Applications



1 2 3 4 5 6 7 8 9 PIPING SYSTEMS / LINED



RUBBER & COMPOSITE HOSE

Lined Piping Systems - Cross

Lined Cross

Construction : Smoothbore

Pipe : Carbon Steel / Stainless Steel (Other specialty metals on request)

Liner: PTFE, PFA, PVDF, PP, FEP, ETFE

Size Available : 1" - 12" (Larger sizes upon Request)

Vacuum : Full Vacuum

Temperature : -30°C to 260°C

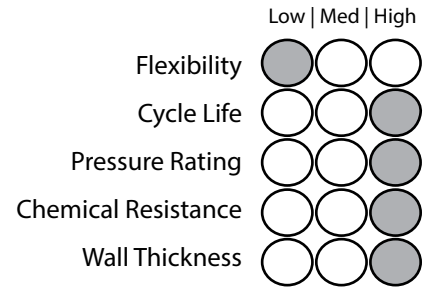

Construction

Use:

Our range of products are used in various industries such as Chemicals, Refineries, Pesticides, Petrochemicals, Steel, Food-Processing, Beverages, Alcohols and Acids, Pharmaceuticals, Circuit Breakers, Fertilizers, Desalination.

Standards:

ASTM F1545, AS4041:2006 Class 1, ASME IX:2010

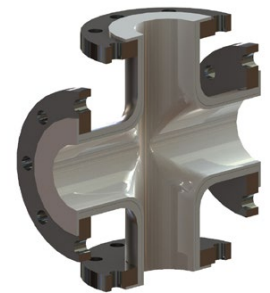

Specifications

Part Number:	Size	Face to Centre (X)	Liner Thickness	Flared Dia
	inch			
TLPCa-25-AF3-AF3-b	1"	89	3.30	48
TLPCa-38-AF3-AF3-b	1 1/2"	102	3.80	69
TLPCa-50-AF3-AF3-b	2"	114	4.00	88
TLPCa-80-AF3-AF3-b	3"	140	4.00	118
TLPCa-100-AF3-AF3-b	4"	165	4.00	151
TLPCa-150-AF3-AF3-b	6"	203	7.00	204
TLPCa-200-AF3-AF3-b	8"	229	8.00	256
TLPCa-250-AF3-AF3-b	10"	279	8.00	312
TLPCa-300-AF3-AF3-b	12"	305	10.80	376

At temp(°C)	ANSI class 150	ANSI class 300
°C	kpa	kpa
40	1760	3160
100	1650	2740
150	1510	2430
200	1400	2080
250	1200	1720

Part Number Key:

a = Pipe Material

6S = 316 Stainless Steel | 4S = 304 Stainless Steel | MS = Carbon Steel

b = 316 Stainless Steel Flange Type

A1 = ANSI 150lb | TE = Table E | TD = Table D | D16 = DIN 16

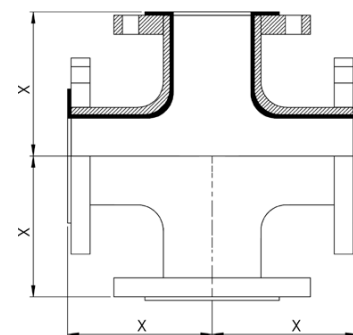

Applications



Lined Piping Systems - Concentric Reducer

Lined Concentric Reducer

Construction : Smoothbore

Pipe : Carbon Steel / Stainless Steel
(Other specialty metals on request)

Liner: PTFE, PFA, PVDF, PP, FEP, ETFE

Size Available : 1/2" - 12"
(Larger sizes upon Request)

Vacuum : Full Vacuum

Temperature : -30°C to 260°C

	Low	Med	High
Flexibility	○	○	○
Cycle Life	○	○	○
Pressure Rating	○	○	○
Chemical Resistance	○	○	○
Wall Thickness	○	○	○

Construction

Use:

Our range of products are used in various industries such as Chemicals, Refineries, Pesticides, Petrochemicals, Steel, Food-Processing, Beverages, Alcohols and Acids, Pharmaceuticals, Circuit Breakers, Fertilizers, Desalination.

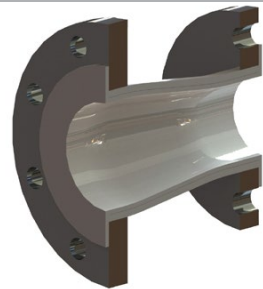

Standards:

ASTM F1545, AS4041:2006 Class 1, ASME IX:2010

Specifications

Part Number:	Flange Size		Face To Face (X)
	inch	inch	mm
TLPa-CR-25-12-b-b	1"	1/2"	114
TLPa-CR-25-20-b-b	1"	3/4"	114
TLPa-CR-38-25-b-b	1 1/2"	1"	114
TLPa-CR-38-25-b-b	1 1/2"	1"	114
TLPa-CR-50-25-b-b	2"	1"	127
TLPa-CR-50-38-b-b	2"	1 1/2"	127
TLPa-CR-80-38-b-b	3"	1 1/2"	152
TLPa-CR-80-50-b-b	3"	2"	152
TLPa-CR-100-38-b-b	4"	1 1/2"	178
TLPa-CR-100-50-b-b	4"	2"	178
TLPa-CR-100-80-b-b	4"	3"	178
TLPa-CR-150-80-b-b	6"	3"	229
TLPa-CR-150-100-b-b	6"	4"	229
TLPa-CR-200-100-b-b	8"	4"	279
TLPa-CR-250-150-b-b	10"	6"	305

At temp(°C)	ANSI class 150	ANSI class 300
°C	kpa	kpa
40	1760	3160
100	1650	2740
150	1510	2430
200	1400	2080
250	1200	1720

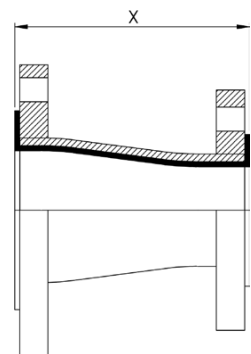

Part Number Key:

a = Pipe Material: 6S = 316 Stainless Steel | 4S = 304 Stainless Steel | MS = Carbon Steel

b = 316 Stainless Steel Flange Type: A1 = ANSI 150lb | TE = Table E | TD = Table D | D16 = DIN 16

Applications





RUBBER & COMPOSITE HOSE

Lined Piping Systems - Eccentric Reducer

Lined Eccentric Reducer

Construction : Smoothbore

Pipe : Carbon Steel / Stainless Steel (Other specialty metals on request)

Liner: PTFE, PFA, PVDF, PP, FEP, ETFE

Size Available : 1" - 12" (Larger sizes upon Request)

Vacuum : Full Vacuum

Temperature : -30°C to 260°C

Low | Med | High

Flexibility

Cycle Life

Pressure Rating

Chemical Resistance

Wall Thickness

Construction

Use:

Our range of products are used in various industries such as Chemicals, Refineries, Pesticides, Petrochemicals, Steel, Food-Processing, Beverages, Alcohols and Acids, Pharmaceuticals, Circuit Breakers, Fertilizers, Desalination.

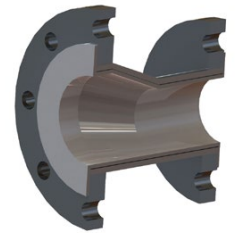

Standards:

ASTM F1545, AS4041:2006 Class 1, ASME IX:2010

Specifications

Part Number:	Flange Size		Face To Face (X)	Eccentricity (E)
	inch	inch	mm	mm
TLPa-ER-38-25-b-b	1 1/2"	1"	114	6
TLPa-ER-50-25-b-b	2"	1"	127	12.2
TLPa-ER-50-38-b-b	2"	1 1/2"	127	6
TLPa-ER-80-25-b-b	3"	1"	152	25
TLPa-ER-80-38-b-b	3"	1 1/2"	152	18.3
TLPa-ER-80-50-b-b	3"	2"	152	14
TLPa-ER-100-50-b-b	4"	2"	178	25
TLPa-ER-100-80-b-b	4"	3"	178	13
TLPa-ER-150-80-b-b	6"	3"	229	35.2
TLPa-ER-150-100-b-b	6"	4"	229	27
TLPa-ER-200-100-b-b	8"	4"	279	46.4
TLPa-ER-200-150-b-b	8"	6"	279	25
TLPa-ER-250-100-b-b	10"	6"	305	52
TLPa-ER-250-200-b-b	10"	8"	305	27
TLPa-ER-300-200-b-b	12"	8"	356	52
TLPa-ER-300-250-b-b	12"	10"	356	25

At temp(°C)	ANSI class 150	ANSI class 300
°C	kpa	kpa
40	1760	3160
100	1650	2740
150	1510	2430
200	1400	2080
250	1200	1720

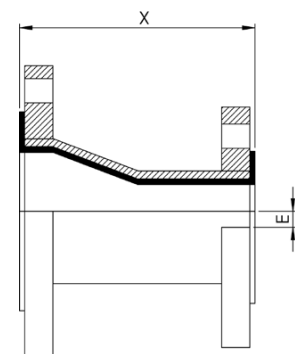

Part Number Key:

a = Pipe Material: 6S = 316 Stainless Steel | 4S = 304 Stainless Steel | MS = Carbon Steel

b = 316 Stainless Steel Flange Type: A1 = ANSI 150lb | TE = Table E | TD = Table D | D16 = DIN 16

Applications



1 2 3 4 5 6 7 8 9 PIPING SYSTEMS / LINED

Piping Systems

Piping Systems

Construction : Smoothbore

Pipe : Carbon Steel / Stainless Steel (Other specialty metals on request)

Size Available : 1" - 14" (Larger sizes upon Request)

Vacuum : Full Vacuum

Temperature : 900°C

	Low	Med	High
Flexibility			
Cycle Life			
Pressure Rating			
Chemical Resistance			
Wall Thickness			

Construction

Use:

Our range of piping systems are used in various industries such as oil and gas refineries, alumina refineries, chemical process plants, aluminium smelters, tunnels, water treatment plants, food & pharmaceutical plants.

Welding Standards:

- AS4041:2006 Class 1
- ASME IX:2010
- ASME B31.3: 2008
- AS/NZS 2992:1998

Welding Processes:

- Gas Tungsten Arc Welding (GTAW)
- Metal Inert Gas Welding (MIGW)
- Manual Metal Arc Welding (MMAW)
- Flux Cored Arc Welding (FCAW)

Piping Standards:

- ANSI
- ASME
- ISO
- DIN



Applications



1
2
3
4
5
6
7
8
9

PIPING SYSTEMS / LINED



06



FITTINGS, FLANGES & COUPLINGS

The Range:

HYDRAULIC FITTINGS

Size : 1/4" to 2"
Material : 316 Stainless Steel

Page 206



INDUSTRIAL FITTINGS

Size : 1/8" to 24"
Material : 316 Stainless Steel

Page 219



COMPOSITE HOSE FITTINGS

Size : 1/8" to 1 1/4"
Material : 316 Stainless Steel & Aluminum

Page 228



PTFE FITTINGS

Size : 1/8" to 4"
Material : 316 Stainless Steel

Page 231



HYGIENIC FITTINGS

Size : 1/2" to 8"
Material : 316 Stainless Steel

Page 242



BITUMEN FITTINGS

Size : 2 1/2"
Material : Bronze & Aluminum

Page 248

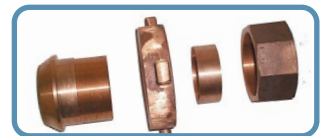

FLANGES

Size : 1/2" to 24"
Material : 316 Stainless Steel

Page 250

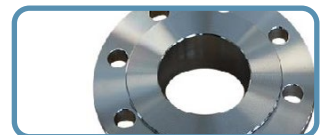

SAFETY BREAKAWAY COUPLINGS

Size : 1" to 12"
Material : 316 Stainless Steel, Aluminum & Brass

Page 256



DRY DISCONNECT COUPLINGS

Size : 1" to 6"
Material : 316 Stainless Steel, Aluminum & Brass

Page 256



EMERGENCY RELEASE COUPLINGS

Size : 1" to 12"
Material : 316 Stainless Steel, Carbon Steel & Aluminum

Page 256



FLANGE CAMLOCK COUPLINGS

Size : 2" to 24"
Material : Stainless Steel, Carbon Steel

Page 256



Hydraulic Fittings



PART NUMBER	BSPT SEATED 316 S/S HEX MALE x HYDRAULIC HOSETAIL
AF16SHH-0202-BTS	1/8" x 1/8"
AF16SHH-0203-BTS	1/8" x 3/16"
AF16SHH-0204-BTS	1/8" x 1/4"
AF16SHH-0404-BTS	1/4" x 1/4"
AF16SHH-0405-BTS	1/4" x 5/16"
AF16SHH-0406-BTS	1/4" x 3/8"
AF16SHH-0604-BTS	3/8" x 1/4"
AF16SHH-0606-BTS	3/8" x 3/8"
AF16SHH-0608-BTS	3/8" x 1/2"
AF16SHH-0804-BTS	1/2" x 1/4"
AF16SHH-0806-BTS	1/2" x 3/8"
AF16SHH-0808-BTS	1/2" x 1/2"
AF16SHH-0812-BTS	1/2" x 3/4"
AF16SHH-0816-BTS	1/2" x 1"
AF16SHH-1206-BTS	3/4" x 3/8"
AF16SHH-1208-BTS	3/4" x 1/2"
AF16SHH-1212-BTS	3/4" x 3/4"
AF16SHH-1216-BTS	3/4" x 1"
AF16SHH-1608-BTS	1" x 1/2"
AF16SHH-1612-BTS	1" x 3/4"
AF16SHH-1616-BTS	1" x 1"
AF16SHH-1620-BTS	1" x 1 1/4"
AF16SHH-2016-BTS	1 1/4" x 1"
AF16SHH-2020-BTS	1 1/4" x 1 1/4"
AF16SHH-2024-BTS	1 1/4" x 1 1/2"
AF16SHH-2420-BTS	1 1/2" x 1 1/4"
AF16SHH-2424-BTS	1 1/2" x 1 1/2"
AF16SHH-2432-BTS	1 1/2" x 2"
AF16SHH-3220-BTS	2" x 1 1/4"
AF16SHH-3224-BTS	2" x 1 1/2"
AF16SHH-3232-BTS	2" x 2"

PART NUMBER	BSPP CONE SEAT 316 S/S FEMALE SWIVEL x HYDRAULIC HOSETAIL
AF26SHH-0202-BPCS	1/8" x 1/8"
AF26SHH-0203-BPCS	1/8" x 3/16"
AF26SHH-0204-BPCS	1/8" x 1/4"
AF26SHH-0403-BPCS	1/4" x 3/16"
AF26SHH-0404-BPCS	1/4" x 1/4"
AF26SHH-0406-BPCS	1/4" x 3/8"
AF26SHH-0604-BPCS	3/8" x 1/4"
AF26SHH-0606-BPCS	3/8" x 3/8"
AF26SHH-0608-BPCS	3/8" x 1/2"
AF26SHH-0804-BPCS	1/2" x 1/4"
AF26SHH-0806-BPCS	1/2" x 3/8"
AF26SHH-0808-BPCS	1/2" x 1/2"
AF26SHH-0812-BPCS	1/2" x 3/4"
AF26SHH-0816-BPCS	1/2" x 1"
AF26SHH-1206-BPCS	3/4" x 3/8"
AF26SHH-1208-BPCS	3/4" x 1/2"
AF26SHH-1212-BPCS	3/4" x 3/4"
AF26SHH-1216-BPCS	3/4" x 1"
AF26SHH-1608-BPCS	1" x 1/2"
AF26SHH-1612-BPCS	1" x 3/4"
AF26SHH-1616-BPCS	1" x 1"
AF26SHH-1620-BPCS	1" x 1 1/4"
AF26SHH-2016-BPCS	1 1/4" x 1"
AF26SHH-2020-BPCS	1 1/4" x 1 1/4"
AF26SHH-2024-BPCS	1 1/4" x 1 1/2"
AF26SHH-2420-BPCS	1 1/2" x 1 1/4"
AF26SHH-2424-BPCS	1 1/2" x 1 1/2"
AF26SHH-2432-BPCS	1 1/2" x 2"
AF26SHH-3220-BPCS	2" x 1 1/4"
AF26SHH-3224-BPCS	2" x 1 1/2"
AF26SHH-3232-BPCS	2" x 2"

Hydraulic Fittings



PART NUMBER	BSPP SEATED 316 S/S FEMALE SWIVEL x 90° SWEPT BEND x HYDRAULIC HOSETAIL
AF26S90HH-0202-BPS	1/8" x 1/8"
AF26S90HH-0203-BPS	1/8" x 3/16"
AF26S90HH-0204-BPS	1/8" x 1/4"
AF26S90HH-0403-BPS	1/4" x 3/16"
AF26S90HH-0404-BPS	1/4" x 1/4"
AF26S90HH-0406-BPS	1/4" x 3/8"
AF26S90HH-0604-BPS	3/8" x 1/4"
AF26S90HH-0606-BPS	3/8" x 3/8"
AF26S90HH-0608-BPS	3/8" x 1/2"
AF26S90HH-0804-BPS	1/2" x 1/4"
AF26S90HH-0806-BPS	1/2" x 3/8"
AF26S90HH-0808-BPS	1/2" x 1/2"
AF26S90HH-0812-BPS	1/2" x 3/4"
AF26S90HH-0816-BPS	1/2" x 1"
AF26S90HH-1206-BPS	3/4" x 3/8"
AF26S90HH-1208-BPS	3/4" x 1/2"
AF26S90HH-1212-BPS	3/4" x 3/4"
AF26S90HH-1216-BPS	3/4" x 1"
AF26S90HH-1608-BPS	1" x 1/2"
AF26S90HH-1612-BPS	1" x 3/4"
AF26S90HH-1616-BPS	1" x 1"
AF26S90HH-1620-BPS	1" x 1 1/4"
AF26S90HH-2016-BPS	1 1/4" x 1"
AF26S90HH-2020-BPS	1 1/4" x 1 1/4"
AF26S90HH-2024-BPS	1 1/4" x 1 1/2"
AF26S90HH-2420-BPS	1 1/2" x 1 1/4"
AF26S90HH-2424-BPS	1 1/2" x 1 1/2"
AF26S90HH-2432-BPS	1 1/2" x 2"
AF26S90HH-3220-BPS	2" x 1 1/4"
AF26S90HH-3224-BPS	2" x 1 1/2"
AF26S90HH-3232-BPS	2" x 2"

PART NUMBER	BSPP SEATED 316 S/S FEMALE SWIVEL x 45° SWEPT BEND x HYDRAULIC HOSETAIL
AF26S45HH-0202-BPS	1/8" x 1/8"
AF26S45HH-0203-BPS	1/8" x 3/16"
AF26S45HH-0204-BPS	1/8" x 1/4"
AF26S45HH-0403-BPS	1/4" x 3/16"
AF26S45HH-0404-BPS	1/4" x 1/4"
AF26S45HH-0406-BPS	1/4" x 3/8"
AF26S45HH-0604-BPS	3/8" x 1/4"
AF26S45HH-0606-BPS	3/8" x 3/8"
AF26S45HH-0608-BPS	3/8" x 1/2"
AF26S45HH-0804-BPS	1/2" x 1/4"
AF26S45HH-0806-BPS	1/2" x 3/8"
AF26S45HH-0808-BPS	1/2" x 1/2"
AF26S45HH-0812-BPS	1/2" x 3/4"
AF26S45HH-0816-BPS	1/2" x 1"
AF26S45HH-1206-BPS	3/4" x 3/8"
AF26S45HH-1208-BPS	3/4" x 1/2"
AF26S45HH-1212-BPS	3/4" x 3/4"
AF26S45HH-1216-BPS	3/4" x 1"
AF26S45HH-1608-BPS	1" x 1/2"
AF26S45HH-1612-BPS	1" x 3/4"
AF26S45HH-1616-BPS	1" x 1"
AF26S45HH-1620-BPS	1" x 1 1/4"
AF26S45HH-2016-BPS	1 1/4" x 1"
AF26S45HH-2020-BPS	1 1/4" x 1 1/4"
AF26S45HH-2024-BPS	1 1/4" x 1 1/2"
AF26S45HH-2420-BPS	1 1/2" x 1 1/4"
AF26S45HH-2424-BPS	1 1/2" x 1 1/2"
AF26S45HH-2432-BPS	1 1/2" x 2"
AF26S45HH-3220-BPS	2" x 1 1/4"
AF26S45HH-3224-BPS	2" x 1 1/2"
AF26S45HH-3232-BPS	2" x 2"

Hydraulic Fittings

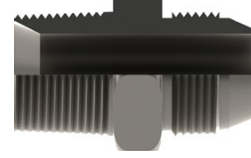
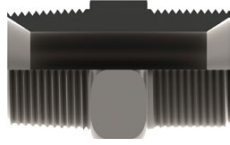

PART NUMBER	BSPT/P 3000 lb 316 S/S SEATED HEX MALE NIPPLE
HMN6S-0202-BT3SBP3S	1/8" x 1/8"
HMN6S-0402-BT3SBP3S	1/4" x 1/8"
HMN6S-0404-BT3SBP3S	1/4" x 1/4"
HMN6S-0602-BT3SBP3S	3/8" x 1/8"
HMN6S-0604-BT3SBP3S	3/8" x 1/4"
HMN6S-0606-BT3SBP3S	3/8" x 3/8"
HMN6S-0804-BT3SBP3S	1/2" x 1/4"
HMN6S-0806-BT3SBP3S	1/2" x 3/8"
HMN6S-0808-BT3SBP3S	1/2" x 1/2"
HMN6S-1010-BT3SBP3S	5/8" x 5/8"
HMN6S-1206-BT3SBP3S	3/4" x 3/8"
HMN6S-1208-BT3SBP3S	3/4" x 1/2"
HMN6S-1212-BT3SBP3S	3/4" x 3/4"
HMN6S-1608-BT3SBP3S	1" x 1/2"
HMN6S-1612-BT3SBP3S	1" x 3/4"
HMN6S-1616-BT3SBP3S	1" x 1"
HMN6S-2012-BT3SBP3S	1 1/4" x 3/4"
HMN6S-2016-BT3SBP3S	1 1/4" x 1"
HMN6S-2020-BT3SBP3S	1 1/4" x 1 1/4"
HMN6S-2412-BT3SBP3S	1 1/2" x 3/4"
HMN6S-2416-BT3SBP3S	1 1/2" x 1"
HMN6S-2420-BT3SBP3S	1 1/2" x 1 1/4"
HMN6S-2424-BT3SBP3S	1 1/2" x 1 1/2"
HMN6S-3212-BT3SBP3S	2" x 3/4"
HMN6S-3216-BT3SBP3S	2" x 1"
HMN6S-3220-BT3SBP3S	2" x 1 1/4"
HMN6S-3224-BT3SBP3S	2" x 1 1/2"
HMN6S-3232-BT3SBP3S	2" x 2"

PART NUMBER	BSPT x JIC 316 S/S 3000 lb SEATED HEX MALE NIPPLE
HMN6S-0207-BT3SJC	1/8" x 7/16"
HMN6S-0208-BT3SJC	1/8" x 1/2"
HMN6S-0209-BT3SJC	1/8" x 9/16"
HMN6S-0407-BT3SJC	1/4" x 7/16"
HMN6S-0408-BT3SJC	1/4" x 1/2"
HMN6S-0409-BT3SJC	1/4" x 9/16"
HMN6S-0412-BT3SJC	1/4" x 3/4"
HMN6S-0414-BT3SJC	1/4" x 7/8"
HMN6S-0607-BT3SJC	3/8" x 7/16"
HMN6S-0608-BT3SJC	3/8" x 1/2"
HMN6S-0609-BT3SJC	3/8" x 9/16"
HMN6S-0612-BT3SJC	3/8" x 3/4"
HMN6S-0614-BT3SJC	3/8" x 7/8"
HMN6S-0617-BT3SJC	3/8" x 1 1/16"
HMN6S-0807-BT3SJC	1/2" x 7/16"
HMN6S-0809-BT3SJC	1/2" x 9/16"
HMN6S-0812-BT3SJC	1/2" x 3/4"
HMN6S-0814-BT3SJC	1/2" x 7/8"
HMN6S-0817-BT3SJC	1/2" x 1 1/16"
HMN6S-0821-BT3SJC	1/2" x 1 5/16"
HMN6S-1012-BT3SJC	5/8" x 3/4"
HMN6S-1014-BT3SJC	5/8" x 7/8"
HMN6S-1209-BT3SJC	3/4" x 9/16"
HMN6S-1212-BT3SJC	3/4" x 3/4"
HMN6S-1214-BT3SJC	3/4" x 7/8"
HMN6S-1217-BT3SJC	3/4" x 1 1/16"
HMN6S-1219-BT3SJC	3/4" x 1 3/16"
HMN6S-1221-BT3SJC	3/4" x 1 5/16"
HMN6S-1614-BT3SJC	1" x 7/8"
HMN6S-1617-BT3SJC	1" x 1 1/16"
HMN6S-1619-BT3SJC	1" x 1 3/16"
HMN6S-1621-BT3SJC	1" x 1 5/16"
HMN6S-1626-BT3SJC	1" x 1 5/8"
HMN6S-2017-BT3SJC	1 1/4" x 1 1/16"
HMN6S-2021-BT3SJC	1 1/4" x 1 5/16"
HMN6S-2026-BT3SJC	1 1/4" x 1 5/8"
HMN6S-2421-BT3SJC	1 1/2" x 1 5/16"
HMN6S-2426-BT3SJC	1 1/2" x 1 5/8"
HMN6S-2430-BT3SJC	1 1/2" x 1 7/8"
HMN6S-3240-BT3SJC	2" x 2 1/2"

Hydraulic Fittings

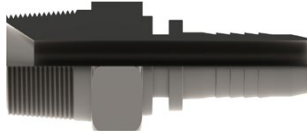

PART NUMBER	NPT SEATED 316 S/S HEX MALE x HYDRAULIC HOSETAIL
AF16SHH-0202-NTS	1/8" x 1/8"
AF16SHH-0203-NTS	1/8" x 3/16"
AF16SHH-0204-NTS	1/8" x 1/4"
AF16SHH-0404-NTS	1/4" x 1/4"
AF16SHH-0406-NTS	1/4" x 3/8"
AF16SHH-0604-NTS	3/8" x 1/4"
AF16SHH-0606-NTS	3/8" x 3/8"
AF16SHH-0608-NTS	3/8" x 1/2"
AF16SHH-0804-NTS	1/2" x 1/4"
AF16SHH-0806-NTS	1/2" x 3/8"
AF16SHH-0808-NTS	1/2" x 1/2"
AF16SHH-0812-NTS	1/2" x 3/4"
AF16SHH-0816-NTS	1/2" x 1"
AF16SHH-1206-NTS	3/4" x 3/8"
AF16SHH-1208-NTS	3/4" x 1/2"
AF16SHH-1212-NTS	3/4" x 3/4"
AF16SHH-1216-NTS	3/4" x 1"
AF16SHH-1608-NTS	1" x 1/2"
AF16SHH-1612-NTS	1" x 3/4"
AF16SHH-1616-NTS	1" x 1"
AF16SHH-1620-NTS	1" x 1 1/4"
AF16SHH-2016-NTS	1 1/4" x 1"
AF16SHH-2020-NTS	1 1/4" x 1 1/4"
AF16SHH-2024-NTS	1 1/4" x 1 1/2"
AF16SHH-2420-NTS	1 1/2" x 1 1/4"
AF16SHH-2424-NTS	1 1/2" x 1 1/2"
AF16SHH-2432-NTS	1 1/2" x 2"
AF16SHH-3220-NTS	2" x 1 1/4"
AF16SHH-3224-NTS	2" x 1 1/2"
AF16SHH-3232-NTS	2" x 2"

PART NUMBER	NPSM CONE SEAT 316 S/S FEMALE SWIVEL x HYDRAULIC HOSETAIL
AF26SHH-0202-NMCS	1/8" x 1/8"
AF26SHH-0203-NMCS	1/8" x 3/16"
AF26SHH-0204-NMCS	1/8" x 1/4"
AF26SHH-0404-NMCS	1/4" x 1/4"
AF26SHH-0406-NMCS	1/4" x 3/8"
AF26SHH-0604-NMCS	3/8" x 1/4"
AF26SHH-0606-NMCS	3/8" x 3/8"
AF26SHH-0608-NMCS	3/8" x 1/2"
AF26SHH-0804-NMCS	1/2" x 1/4"
AF26SHH-0806-NMCS	1/2" x 3/8"
AF26SHH-0808-NMCS	1/2" x 1/2"
AF26SHH-0812-NMCS	1/2" x 3/4"
AF26SHH-0816-NMCS	1/2" x 1"
AF26SHH-1206-NMCS	3/4" x 3/8"
AF26SHH-1208-NMCS	3/4" x 1/2"
AF26SHH-1212-NMCS	3/4" x 3/4"
AF26SHH-1216-NMCS	3/4" x 1"
AF26SHH-1608-NMCS	1" x 1/2"
AF26SHH-1612-NMCS	1" x 3/4"
AF26SHH-1616-NMCS	1" x 1"
AF26SHH-1620-NMCS	1" x 1 1/4"
AF26SHH-2016-NMCS	1 1/4" x 1"
AF26SHH-2020-NMCS	1 1/4" x 1 1/4"
AF26SHH-2024-NMCS	1 1/4" x 1 1/2"
AF26SHH-2420-NMCS	1 1/2" x 1 1/4"
AF26SHH-2424-NMCS	1 1/2" x 1 1/2"
AF26SHH-2432-NMCS	1 1/2" x 2"
AF26SHH-3220-NMCS	2" x 1 1/4"
AF26SHH-3224-NMCS	2" x 1 1/2"
AF26SHH-3232-NMCS	2" x 2"

Hydraulic Fittings



PART NUMBER	NPSM CONE SEAT 316 S/S FEMALE SWIVEL x 90° SWEPT BEND x HYDRAULIC HOSETAIL
AF26S90HH-0202-NMCS	1/8" x 1/8"
AF26S90HH-0203-NMCS	1/8" x 3/16"
AF26S90HH-0204-NMCS	1/8" x 1/4"
AF26S90HH-0404-NMCS	1/4" x 1/4"
AF26S90HH-0406-NMCS	1/4" x 3/8"
AF26S90HH-0604-NMCS	3/8" x 1/4"
AF26S90HH-0606-NMCS	3/8" x 3/8"
AF26S90HH-0608-NMCS	3/8" x 1/2"
AF26S90HH-0804-NMCS	1/2" x 1/4"
AF26S90HH-0806-NMCS	1/2" x 3/8"
AF26S90HH-0808-NMCS	1/2" x 1/2"
AF26S90HH-0812-NMCS	1/2" x 3/4"
AF26S90HH-0816-NMCS	1/2" x 1"
AF26S90HH-1206-NMCS	3/4" x 3/8"
AF26S90HH-1208-NMCS	3/4" x 1/2"
AF26S90HH-1212-NMCS	3/4" x 3/4"
AF26S90HH-1216-NMCS	3/4" x 1"
AF26S90HH-1608-NMCS	1" x 1/2"
AF26S90HH-1612-NMCS	1" x 3/4"
AF26S90HH-1616-NMCS	1" x 1"
AF26S90HH-1620-NMCS	1" x 1 1/4"
AF26S90HH-2016-NMCS	1 1/4" x 1"
AF26S90HH-2020-NMCS	1 1/4" x 1 1/4"
AF26S90HH-2024-NMCS	1 1/4" x 1 1/2"
AF26S90HH-2420-NMCS	1 1/2" x 1 1/4"
AF26S90HH-2424-NMCS	1 1/2" x 1 1/2"
AF26S90HH-2432-NMCS	1 1/2" x 2"
AF26S90HH-3220-NMCS	2" x 1 1/4"
AF26S90HH-3224-NMCS	2" x 1 1/2"
AF26S90HH-3232-NMCS	2" x 2"

PART NUMBER	NPSM CONE SEAT 316 S/S FEMALE SWIVEL x 45° SWEPT BEND x HYDRAULIC HOSETAIL
AF26S45HH-0202-NMCS	1/8" x 1/8"
AF26S45HH-0203-NMCS	1/8" x 3/16"
AF26S45HH-0204-NMCS	1/8" x 1/4"
AF26S45HH-0404-NMCS	1/4" x 1/4"
AF26S45HH-0406-NMCS	1/4" x 3/8"
AF26S45HH-0604-NMCS	3/8" x 1/4"
AF26S45HH-0606-NMCS	3/8" x 3/8"
AF26S45HH-0608-NMCS	3/8" x 1/2"
AF26S45HH-0804-NMCS	1/2" x 1/4"
AF26S45HH-0806-NMCS	1/2" x 3/8"
AF26S45HH-0808-NMCS	1/2" x 1/2"
AF26S45HH-0812-NMCS	1/2" x 3/4"
AF26S45HH-0816-NMCS	1/2" x 1"
AF26S45HH-1206-NMCS	3/4" x 3/8"
AF26S45HH-1208-NMCS	3/4" x 1/2"
AF26S45HH-1212-NMCS	3/4" x 3/4"
AF26S45HH-1216-NMCS	3/4" x 1"
AF26S45HH-1608-NMCS	1" x 1/2"
AF26S45HH-1612-NMCS	1" x 3/4"
AF26S45HH-1616-NMCS	1" x 1"
AF26S45HH-1620-NMCS	1" x 1 1/4"
AF26S45HH-2016-NMCS	1 1/4" x 1"
AF26S45HH-2020-NMCS	1 1/4" x 1 1/4"
AF26S45HH-2024-NMCS	1 1/4" x 1 1/2"
AF26S45HH-2420-NMCS	1 1/2" x 1 1/4"
AF26S45HH-2424-NMCS	1 1/2" x 1 1/2"
AF26S45HH-2432-NMCS	1 1/2" x 2"
AF26S45HH-3220-NMCS	2" x 1 1/4"
AF26S45HH-3224-NMCS	2" x 1 1/2"
AF26S45HH-3232-NMCS	2" x 2"

Hydraulic Fittings

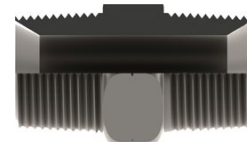
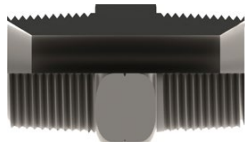

PART NUMBER	NPT 3000 lb 316 S/S SEATED HEX MALE NIPPLE
HMN6S-0202-NT3S	1/8" x 1/8"
HMN6S-0402-NT3S	1/4" x 1/8"
HMN6S-0404-NT3S	1/4" x 1/4"
HMN6S-0602-NT3S	3/8" x 1/8"
HMN6S-0604-NT3S	3/8" x 1/4"
HMN6S-0606-NT3S	3/8" x 3/8"
HMN6S-0804-NT3S	1/2" x 1/4"
HMN6S-0806-NT3S	1/2" x 3/8"
HMN6S-0808-NT3S	1/2" x 1/2"
HMN6S-1010-NT3S	5/8" x 5/8"
HMN6S-1206-NT3S	3/4" x 3/8"
HMN6S-1208-NT3S	3/4" x 1/2"
HMN6S-1212-NT3S	3/4" x 3/4"
HMN6S-1608-NT3S	1" x 1/2"
HMN6S-1612-NT3S	1" x 3/4"
HMN6S-1616-NT3S	1" x 1"
HMN6S-2012-NT3S	1 1/4" x 3/4"
HMN6S-2016-NT3S	1 1/4" x 1"
HMN6S-2020-NT3S	1 1/4" x 1 1/4"
HMN6S-2412-NT3S	1 1/2" x 3/4"
HMN6S-2416-NT3S	1 1/2" x 1"
HMN6S-2420-NT3S	1 1/2" x 1 1/4"
HMN6S-2424-NT3S	1 1/2" x 1 1/2"
HMN6S-3212-NT3S	2" x 3/4"
HMN6S-3216-NT3S	2" x 1"
HMN6S-3220-NT3S	2" x 1 1/4"
HMN6S-3224-NT3S	2" x 1 1/2"
HMN6S-3232-NT3S	2" x 2"
HMN6S-4024-NT3S	2 1/2" x 1 1/2"
HMN6S-4040-NT3S	2 1/2" x 2 1/2"

PART NUMBER	BSPT / NPT 3000 lb 316 S/S SEATED HEX MALE NIPPLE
HMN6S-0202-BT3SNT3S	1/8" x 1/8"
HMN6S-0402-BT3SNT3S	1/4" x 1/8"
HMN6S-0404-BT3SNT3S	1/4" x 1/4"
HMN6S-0602-BT3SNT3S	3/8" x 1/8"
HMN6S-0604-BT3SNT3S	3/8" x 1/4"
HMN6S-0606-BT3SNT3S	3/8" x 3/8"
HMN6S-0804-BT3SNT3S	1/2" x 1/4"
HMN6S-0806-BT3SNT3S	1/2" x 3/8"
HMN6S-0808-BT3SNT3S	1/2" x 1/2"
HMN6S-1010-BT3SNT3S	5/8" x 5/8"
HMN6S-1206-BT3SNT3S	3/4" x 3/8"
HMN6S-1208-BT3SNT3S	3/4" x 1/2"
HMN6S-1212-BT3SNT3S	3/4" x 3/4"
HMN6S-1608-BT3SNT3S	1" x 1/2"
HMN6S-1612-BT3SNT3S	1" x 3/4"
HMN6S-1616-BT3SNT3S	1" x 1"
HMN6S-2012-BT3SNT3S	1 1/4" x 3/4"
HMN6S-2016-BT3SNT3S	1 1/4" x 1"
HMN6S-2020-BT3SNT3S	1 1/4" x 1 1/4"
HMN6S-2412-BT3SNT3S	1 1/2" x 3/4"
HMN6S-2416-BT3SNT3S	1 1/2" x 1"
HMN6S-2420-BT3SNT3S	1 1/2" x 1 1/4"
HMN6S-2424-BT3SNT3S	1 1/2" x 1 1/2"
HMN6S-3212-BT3SNT3S	2" x 3/4"
HMN6S-3216-BT3SNT3S	2" x 1"
HMN6S-3220-BT3SNT3S	2" x 1 1/4"
HMN6S-3224-BT3SNT3S	2" x 1 1/2"
HMN6S-3232-BT3SNT3S	2" x 2"
HMN6S-4024-BT3SNT3S	2 1/2" x 1 1/2"
HMN6S-4040-BT3SNT3S	2 1/2" x 2 1/2"

Hydraulic Fittings

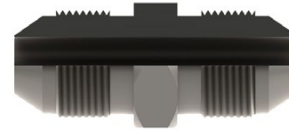
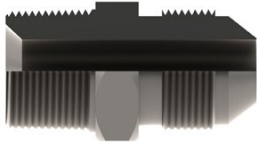

PART NUMBER	NPT / JIC 3000 lb 316 S/S SEATED HEX MALE NIPPLE
HMN6S-0207-NT3SJC	1/8" x 7/16"
HMN6S-0208-NT3SJC	1/8" x 1/2"
HMN6S-0209-NT3SJC	1/8" x 9/16"
HMN6S-0407-NT3SJC	1/4" x 7/16"
HMN6S-0408-NT3SJC	1/4" x 1/2"
HMN6S-0409-NT3SJC	1/4" x 9/16"
HMN6S-0412-NT3SJC	1/4" x 3/4"
HMN6S-0414-NT3SJC	1/4" x 7/8"
HMN6S-0607-NT3SJC	3/8" x 7/16"
HMN6S-0608-NT3SJC	3/8" x 1/2"
HMN6S-0609-NT3SJC	3/8" x 9/16"
HMN6S-0612-NT3SJC	3/8" x 3/4"
HMN6S-0614-NT3SJC	3/8" x 7/8"
HMN6S-0617-NT3SJC	3/8" x 1 1/16"
HMN6S-0807-NT3SJC	1/2" x 7/16"
HMN6S-0809-NT3SJC	1/2" x 9/16"
HMN6S-0812-NT3SJC	1/2" x 3/4"
HMN6S-0814-NT3SJC	1/2" x 7/8"
HMN6S-0817-NT3SJC	1/2" x 1 1/16"
HMN6S-0821-NT3SJC	1/2" x 1 5/16"
HMN6S-1012-NT3SJC	5/8" x 3/4"
HMN6S-1014-NT3SJC	5/8" x 7/8"
HMN6S-1209-NT3SJC	3/4" x 9/16"
HMN6S-1212-NT3SJC	3/4" x 3/4"
HMN6S-1214-NT3SJC	3/4" x 7/8"
HMN6S-1217-NT3SJC	3/4" x 1 1/16"
HMN6S-1219-NT3SJC	3/4" x 1 3/16"
HMN6S-1221-NT3SJC	3/4" x 1 5/16"
HMN6S-1614-NT3SJC	1" x 7/8"
HMN6S-1617-NT3SJC	1" x 1 1/16"
HMN6S-1619-NT3SJC	1" x 1 3/16"
HMN6S-1621-NT3SJC	1" x 1 5/16"
HMN6S-1626-NT3SJC	1" x 1 5/8"
HMN6S-2017-NT3SJC	1 1/4" x 1 1/16"
HMN6S-2021-NT3SJC	1 1/4" x 1 5/16"
HMN6S-2026-NT3SJC	1 1/4" x 1 5/8"
HMN6S-2421-NT3SJC	1 1/2" x 1 5/16"
HMN6S-2426-NT3SJC	1 1/2" x 1 5/8"
HMN6S-2430-NT3SJC	1 1/2" x 1 7/8"
HMN6S-3240-NT3SJC	2" x 2 1/2"

PART NUMBER	JIC 316 S/S 3000 lb HEX MALE NIPPLE
HMN6S-0707-JC	7/16" x 7/16"
HMN6S-0709-JC	7/16" x 9/16"
HMN6S-0712-JC	7/16" x 3/4"
HMN6S-0714-JC	7/16" x 7/8"
HMN6S-0717-JC	7/16" x 1 1/16"
HMN6S-0808-JC	1/2" x 1/2"
HMN6S-0907-JC	9/16" x 7/16"
HMN6S-0909-JC	9/16" x 9/16"
HMN6S-0912-JC	9/16" x 3/4"
HMN6S-0914-JC	9/16" x 7/8"
HMN6S-0917-JC	9/16" x 1 1/16"
HMN6S-0921-JC	9/16" x 1 5/16"
HMN6S-1209-JC	3/4" x 9/16"
HMN6S-1212-JC	3/4" x 3/4"
HMN6S-1214-JC	3/4" x 7/8"
HMN6S-1217-JC	3/4" x 1 1/16"
HMN6S-1221-JC	3/4" x 1 5/16"
HMN6S-1412-JC	7/8" x 3/4"
HMN6S-1414-JC	7/8" x 7/8"
HMN6S-1417-JC	7/8" x 1 1/16"
HMN6S-1707-JC	1 1/16" x 7/16"
HMN6S-1708-JC	1 1/16" x 1/2"
HMN6S-1709-JC	1 1/16" x 9/16"
HMN6S-1712-JC	1 1/16" x 3/4"
HMN6S-1714-JC	1 1/16" x 7/8"
HMN6S-1717-JC	1 1/16" x 1 1/16"
HMN6S-1721-JC	1 1/16" x 1 5/16"
HMN6S-1919-JC	1 3/16" x 1 3/16"
HMN6S-2112-JC	1 5/16" x 3/4"
HMN6S-2114-JC	1 5/16" x 7/8"
HMN6S-2117-JC	1 5/16" x 1 1/16"
HMN6S-2121-JC	1 5/16" x 1 5/16"
HMN6S-2126-JC	1 5/16" x 1 5/8"
HMN6S-2621-JC	1 5/8" x 1 5/16"
HMN6S-2626-JC	1 5/8" x 1 5/8"
HMN6S-3030-JC	1 7/8" x 1 7/8"
HMN6S-4040-JC	2 1/2" x 2 1/2"

Hydraulic Fittings



PART NUMBER	JIC 316 S/S HEX MALE x HYDRAULIC HOSETAIL
AF16SHH-0702-JC	7/16" x 1/8"
AF16SHH-0703-JC	7/16" x 3/16"
AF16SHH-0704-JC	7/16" x 1/4"
AF16SHH-0706-JC	7/16" x 3/8"
AF16SHH-0904-JC	9/16" x 1/4"
AF16SHH-0906-JC	9/16" x 3/8"
AF16SHH-0908-JC	9/16" x 1/2"
AF16SHH-1204-JC	3/4" x 1/4"
AF16SHH-1206-JC	3/4" x 3/8"
AF16SHH-1208-JC	3/4" x 1/2"
AF16SHH-1210-JC	3/4" x 5/8"
AF16SHH-1406-JC	7/8" x 3/8"
AF16SHH-1408-JC	7/8" x 1/2"
AF16SHH-1410-JC	7/8" x 5/8"
AF16SHH-1412-JC	7/8" x 3/4"
AF16SHH-1710-JC	1 1/16" x 5/8"
AF16SHH-1712-JC	1 1/16" x 3/4"
AF16SHH-1716-JC	1 1/16" x 1"
AF16SHH-1912-JC	1 3/16" x 3/4"
AF16SHH-1916-JC	1 3/16" x 1"
AF16SHH-2112-JC	1 5/16" x 3/4"
AF16SHH-2116-JC	1 5/16" x 1"
AF16SHH-2120-JC	1 5/16" x 1 1/4"
AF16SHH-2616-JC	1 5/8" x 1"
AF16SHH-2620-JC	1 5/8" x 1 1/4"
AF16SHH-3020-JC	1 7/8" x 1 1/4"
AF16SHH-3024-JC	1 7/8" x 1 1/2"
AF16SHH-3032-JC	1 7/8" x 2"
AF16SHH-4024-JC	2 1/2" x 1 1/2"
AF16SHH-4032-JC	2 1/2" x 2"

PART NUMBER	JIC 316 S/S FEMALE SWIVEL x HYDRAULIC HOSETAIL
AF26SHH-0702-JC	7/16" x 1/8"
AF26SHH-0703-JC	7/16" x 3/16"
AF26SHH-0704-JC	7/16" x 1/4"
AF26SHH-0706-JC	7/16" x 3/8"
AF26SHH-0904-JC	9/16" x 1/4"
AF26SHH-0906-JC	9/16" x 3/8"
AF26SHH-0908-JC	9/16" x 1/2"
AF26SHH-1204-JC	3/4" x 1/4"
AF26SHH-1206-JC	3/4" x 3/8"
AF26SHH-1208-JC	3/4" x 1/2"
AF26SHH-1210-JC	3/4" x 5/8"
AF26SHH-1406-JC	7/8" x 3/8"
AF26SHH-1408-JC	7/8" x 1/2"
AF26SHH-1410-JC	7/8" x 5/8"
AF26SHH-1412-JC	7/8" x 3/4"
AF26SHH-1710-JC	1 1/16" x 5/8"
AF26SHH-1712-JC	1 1/16" x 3/4"
AF26SHH-1716-JC	1 1/16" x 1"
AF26SHH-1912-JC	1 3/16" x 3/4"
AF26SHH-1916-JC	1 3/16" x 1"
AF26SHH-2112-JC	1 5/16" x 3/4"
AF26SHH-2116-JC	1 5/16" x 1"
AF26SHH-2120-JC	1 5/16" x 1 1/4"
AF26SHH-2616-JC	1 5/8" x 1"
AF26SHH-2620-JC	1 5/8" x 1 1/4"
AF26SHH-3020-JC	1 7/8" x 1 1/4"
AF26SHH-3024-JC	1 7/8" x 1 1/2"
AF26SHH-3032-JC	1 7/8" x 2"
AF26SHH-4024-JC	2 1/2" x 1 1/2"
AF26SHH-4032-JC	2 1/2" x 2"

Hydraulic Fittings



PART NUMBER	JIC 316 S/S FEMALE SWIVEL x 90° SWEPT BEND x HYDRAULIC HOSETAIL
AF26S90HH-0702-JC	7/16" x 1/8"
AF26S90HH-0703-JC	7/16" x 3/16"
AF26S90HH-0704-JC	7/16" x 1/4"
AF26S90HH-0706-JC	7/16" x 3/8"
AF26S90HH-0904-JC	9/16" x 1/4"
AF26S90HH-0906-JC	9/16" x 3/8"
AF26S90HH-0908-JC	9/16" x 1/2"
AF26S90HH-1204-JC	3/4" x 1/4"
AF26S90HH-1206-JC	3/4" x 3/8"
AF26S90HH-1208-JC	3/4" x 1/2"
AF26S90HH-1210-JC	3/4" x 5/8"
AF26S90HH-1406-JC	7/8" x 3/8"
AF26S90HH-1408-JC	7/8" x 1/2"
AF26S90HH-1410-JC	7/8" x 5/8"
AF26S90HH-1412-JC	7/8" x 3/4"
AF26S90HH-1710-JC	1 1/16" x 5/8"
AF26S90HH-1712-JC	1 1/16" x 3/4"
AF26S90HH-1716-JC	1 1/16" x 1"
AF26S90HH-1912-JC	1 3/16" x 3/4"
AF26S90HH-1916-JC	1 3/16" x 1"
AF26S90HH-2112-JC	1 5/16" x 3/4"
AF26S90HH-2116-JC	1 5/16" x 1"
AF26S90HH-2120-JC	1 5/16" x 1 1/4"
AF26S90HH-2616-JC	1 5/8" x 1"
AF26S90HH-2620-JC	1 5/8" x 1 1/4"
AF26S90HH-3020-JC	1 7/8" x 1 1/4"
AF26S90HH-3024-JC	1 7/8" x 1 1/2"
AF26S90HH-3032-JC	1 7/8" x 2"
AF26S90HH-4024-JC	2 1/2" x 1 1/2"
AF26S90HH-4032-JC	2 1/2" x 2"

PART NUMBER	JIC 316 S/S FEMALE SWIVEL x 45° SWEPT BEND x HYDRAULIC HOSETAIL
AF26S45HH-0702-JC	7/16" x 1/8"
AF26S45HH-0703-JC	7/16" x 3/16"
AF26S45HH-0704-JC	7/16" x 1/4"
AF26S45HH-0706-JC	7/16" x 3/8"
AF26S45HH-0904-JC	9/16" x 1/4"
AF26S45HH-0906-JC	9/16" x 3/8"
AF26S45HH-0908-JC	9/16" x 1/2"
AF26S45HH-1204-JC	3/4" x 1/4"
AF26S45HH-1206-JC	3/4" x 3/8"
AF26S45HH-1208-JC	3/4" x 1/2"
AF26S45HH-1210-JC	3/4" x 5/8"
AF26S45HH-1406-JC	7/8" x 3/8"
AF26S45HH-1408-JC	7/8" x 1/2"
AF26S45HH-1410-JC	7/8" x 5/8"
AF26S45HH-1412-JC	7/8" x 3/4"
AF26S45HH-1710-JC	1 1/16" x 5/8"
AF26S45HH-1712-JC	1 1/16" x 3/4"
AF26S45HH-1716-JC	1 1/16" x 1"
AF26S45HH-1912-JC	1 3/16" x 3/4"
AF26S45HH-1916-JC	1 3/16" x 1"
AF26S45HH-2112-JC	1 5/16" x 3/4"
AF26S45HH-2116-JC	1 5/16" x 1"
AF26S45HH-2120-JC	1 5/16" x 1 1/4"
AF26S45HH-2616-JC	1 5/8" x 1"
AF26S45HH-2620-JC	1 5/8" x 1 1/4"
AF26S45HH-3020-JC	1 7/8" x 1 1/4"
AF26S45HH-3024-JC	1 7/8" x 1 1/2"
AF26S45HH-3032-JC	1 7/8" x 2"
AF26S45HH-4024-JC	2 1/2" x 1 1/2"
AF26S45HH-4032-JC	2 1/2" x 2"

Hydraulic Fittings

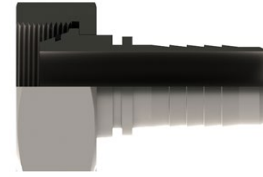
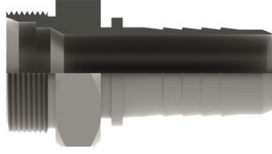

PART NUMBER	METRIC LIGHT DKL MALE 316 S/S x HYDRAULIC HOSETAIL	TUBE SIZE (mm)
AF16SHH-1215-04-DKL	M12 x 1.5 x 1/4"	6 L
AF16SHH-1415-04-DKL	M14 x 1.5 x 1/4"	8 L
AF16SHH-1615-04-DKL	M16 x 1.5 x 1/4"	10 L
AF16SHH-1615-06-DKL	M16 x 1.5 x 3/8"	10 L
AF16SHH-1815-06-DKL	M18 x 1.5 x 3/8"	12 L
AF16SHH-2215-06-DKL	M22 x 1.5 x 3/8"	15 L
AF16SHH-2215-08-DKL	M22 x 1.5 x 1/2"	15 L
AF16SHH-2615-08-DKL	M26 x 1.5 x 1/2"	18 L
AF16SHH-3015-10-DKL	M30 x 1.5 x 5/8"	22 L
AF16SHH-3020-12-DKL	M30 x 2.0 x 3/4"	22 L
AF16SHH-3620-12-DKL	M36 x 2.0 x 3/4"	28 L
AF16SHH-3620-16-DKL	M36 x 2.0 x 1"	28 L
AF16SHH-4520-20-DKL	M45 x 2.0 x 1 1/4"	35 L
AF16SHH-5220-24-DKL	M52 x 2.0 x 1 1/2"	42 L

PART NUMBER	METRIC LIGHT DKL FEMALE 316 S/S x HYDRAULIC HOSETAIL	TUBE SIZE (mm)
AF26SHH-1215-04-DKL	M12 x 1.5 x 1/4"	6 L
AF26SHH-1415-04-DKL	M14 x 1.5 x 1/4"	8 L
AF26SHH-1615-04-DKL	M16 x 1.5 x 1/4"	10 L
AF26SHH-1815-04-DKL	M18 x 1.5 x 1/4"	12 L
AF26SHH-1615-05-DKL	M16 x 1.5 x 5/16"	10 L
AF26SHH-1815-05-DKL	M18 x 1.5 x 5/16"	12 L
AF26SHH-1615-06-DKL	M16 x 1.5 x 3/8"	10 L
AF26SHH-1815-06-DKL	M18 x 1.5 x 3/8"	12 L
AF26SHH-2215-06-DKL	M22 x 1.5 x 3/8"	15 L
AF26SHH-2215-08-DKL	M22 x 1.5 x 1/2"	15 L
AF26SHH-2615-08-DKL	M26 x 1.5 x 1/2"	18 L
AF26SHH-2615-10-DKL	M26 x 1.5 x 5/8"	18 L
AF26SHH-2615-12-DKL	M26 x 1.5 x 3/4"	18 L
AF26SHH-3020-12-DKL	M30 x 2.0 x 3/4"	22 L
AF26SHH-3620-12-DKL	M36 x 2.0 x 3/4"	28 L
AF26SHH-3620-16-DKL	M36 x 2.0 x 1"	28 L
AF26SHH-4520-20-DKL	M45 x 2.0 x 1 1/4"	35 L
AF26SHH-5220-24-DKL	M52 x 2.0 x 1 1/2"	42 L

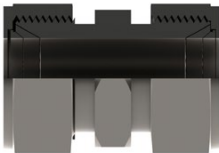

PART NUMBER	METRIC LIGHT DKL 316 S/S COMPRESSION FITTINGS	TUBE SIZE (mm)
COMHM6S-1215-DKL	M12 x 1.5	6 L
COMHM6S-1415-DKL	M14 x 1.5	8 L
COMHM6S-1615-DKL	M16 x 1.5	10 L
COMHM6S-1815-DKL	M18 x 1.5	12 L
COMHM6S-2215-DKL	M22 x 1.5	15 L
COMHM6S-2615-DKL	M26 x 1.5	18 L
COMHM6S-3615-DKL	M36 x 1.5	28 L

Hydraulic Fittings

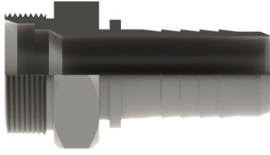

PART NUMBER	METRIC HEAVY DKS MALE 316 S/S x HYDRAULIC HOSETAIL	TUBE SIZE (mm)
AF16SHH-1615-04-DKS	M16 x 1.5 x 1/4"	8 S
AF16SHH-1815-04-DKS	M18 x 1.5 x 1/4"	10 S
AF16SHH-2015-05-DKS	M20 x 1.5 x 5/16"	12 S
AF16SHH-2015-06-DKS	M20 x 1.5 x 3/8"	12 S
AF16SHH-2215-06-DKS	M22 x 1.5 x 3/8"	14 S
AF16SHH-2415-08-DKS	M24 x 1.5 x 1/2"	16 S
AF16SHH-3020-10-DKS	M30 x 2.0 x 5/8"	20 S
AF16SHH-3020-12-DKS	M30 x 2.0 x 3/4"	20 S
AF16SHH-3620-12-DKS	M36 x 2.0 x 3/4"	25 S
AF16SHH-3620-16-DKS	M36 x 2.0 x 1"	30 S
AF16SHH-5220-20-DKS	M52 x 2.0 x 1 1/4"	38 S

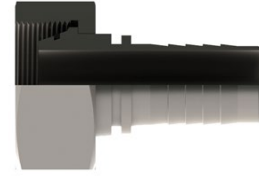

PART NUMBER	METRIC HEAVY DKS FEMALE 316 S/S x HYDRAULIC HOSETAIL	TUBE SIZE (mm)
AF26SHH-1615-04-DKS	M16 x 1.5 x 1/4"	8 S
AF26SHH-1815-04-DKS	M18 x 1.5 x 1/4"	10 S
AF26SHH-2015-05-DKS	M20 x 1.5 x 5/16"	12 S
AF26SHH-2015-06-DKS	M20 x 1.5 x 3/8"	12 S
AF26SHH-2215-06-DKS	M22 x 1.5 x 3/8"	14 S
AF26SHH-2415-08-DKS	M24 x 1.5 x 1/2"	16 S
AF26SHH-3020-10-DKS	M30 x 2.0 x 5/8"	20 S
AF26SHH-3020-12-DKS	M36 x 2.0 x 3/4"	25 S
AF26SHH-4220-16-DKS	M42 x 2.0 x 1"	30 S
AF26SHH-5220-20-DKS	M52 x 2.0 x 1 1/4"	38 S



PART NUMBER	METRIC HEAVY DKS 316 S/S COMPRESSION FITTINGS	TUBE SIZE (mm)
COMHM6S-1615-DKS	M16 x 1.5	8 S
COMHM6S-1815-DKS	M18 x 1.5	10 S
COMHM6S-2015-DKS	M20 x 1.5	12 S
COMHM6S-2415-DKS	M24 x 1.5	16 S
COMHM6S-3620-DKS	M36 x 2.0	25 S
COMHM6S-4220-DKS	M42 x 2.0	30 S

Hydraulic Fittings

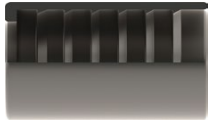

PART NUMBER	1 & 2 WIRE NON SKIVE S/S FERRULE
R1/26S-03	3/16"
R1/26S-04	1/4"
R1/26S-05	5/16"
R1/26S-06	3/8"
R1/26S-08	1/2"
R1/26S-10	5/8"
R1/26S-12	3/4"
R1/26S-16	1"
R1/26S-20	1 1/4"
R1/26S-24	1 1/2"
R1/26S-32	2"

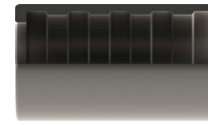

PART NUMBER	R7 & R8 316 S/S FERRULE
R7/86S-02	1/8"
R7/86S-03	3/16"
R7/86S-04	1/4"
R7/86S-05	5/16"
R7/86S-06	3/8"
R7/86S-08	1/2"
R7/86S-10	5/8"
R7/86S-12	3/4"
R7/86S-16	1"



PART NUMBER	PTFE UNIVERSAL 316 S/S FERRULE
PUF6S-02	1/8"
PUF6S-03	3/16"
PUF6S-04	1/4"
PUF6S-05	5/16"
PUF6S-06	3/8"
PUF6S-08	1/2"
PUF6S-10	5/8"
PUF6S-12	3/4"
PUF6S-16	1"
PUF6S-20	1-1/4"
PUF6S-24	1-1/2"
PUF6S-32	2"
PUF6S-40	2-1/2"
PUF6S-48	3"
PUF6S-64	4"

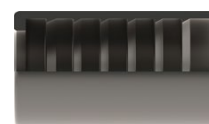

PART NUMBER	PTFE SAE 100 R14 316 S/S FERRULE
R146S-02	1/8"
R146S-03	3/16"
R146S-04	1/4"
R146S-05	5/16"
R146S-06	3/8"
R146S-08	1/2"
R146S-10	5/8"
R146S-12	3/4"
R146S-16	1"

Hydraulic Fittings



PART NUMBER	STANDPIPE 316 S/S x HYDRAULIC HOSETAIL (IMPERIAL)
AF106SHH-I-0202	1/8" x 1/8"
AF106SHH-I-0203	1/8" x 3/16"
AF106SHH-I-0204	1/8" x 1/4"
AF106SHH-I-0303	3/16" x 3/16"
AF106SHH-I-0304	3/16" x 1/4"
AF106SHH-I-0402	1/4" x 1/8"
AF106SHH-I-0403	1/4" x 3/16"
AF106SHH-I-0404	1/4" x 1/4"
AF106SHH-I-0406	1/4" x 3/8"
AF106SHH-I-0408	1/4" x 1/2"
AF106SHH-I-0604	3/8" x 1/4"
AF106SHH-I-0606	3/8" x 3/8"
AF106SHH-I-0608	3/8" x 1/2"
AF106SHH-I-0806	1/2" x 3/8"
AF106SHH-I-0808	1/2" x 1/2"
AF106SHH-I-0810	1/2" x 5/8"
AF106SHH-I-0812	1/2" x 3/4"
AF106SHH-I-1008	5/8" x 1/2"
AF106SHH-I-1010	5/8" x 5/8"
AF106SHH-I-1012	5/8" x 3/4"
AF106SHH-I-1208	1/2" x 3/4"
AF106SHH-I-1210	3/4" x 5/8"
AF106SHH-I-1212	3/4" x 3/4"
AF106SHH-I-1216	3/4" x 1"
AF106SHH-I-1612	1" x 3/4"
AF106SHH-I-1616	1" x 1"
AF106SHH-I-2020	1 1/4" x 1 1/4"
AF106SHH-I-2424	1 1/2" x 1 1/2"
AF106SHH-I-3232	2" x 2"



PART NUMBER	STANDPIPE 316 S/S x HYDRAULIC HOSETAIL (METRIC)
AF106SHH-M-0202	3mm x 1/8"
AF106SHH-M-0303	4mm x 3/16"
AF106SHH-M-0404	6mm x 1/4"
AF106SHH-M-0606	10mm x 3/8"
AF106SHH-M-0808	12mm x 1/2"
AF106SHH-M-1010	15mm x 5/8"
AF106SHH-M-1212	20mm x 3/4"
AF106SHH-M-1616	25mm x 1"
AF106SHH-M-2020	32mm x 1 1/4"
AF106SHH-M-2424	38mm x 1 1/2"
AF106SHH-M-3232	50mm x 2"



PART NUMBER	HYDRAULIC 316 S/S LIFESAVER TAIL
LT6SHH-02	1/8"
LT6SHH-03	3/16"
LT6SHH-04	1/4"
LT6SHH-05	5/16"
LT6SHH-06	3/8"
LT6SHH-08	1/2"
LT6SHH-10	5/8"
LT6SHH-12	3/4"
LT6SHH-16	1"
LT6SHH-20	1 1/4"
LT6SHH-24	1 1/2"
LT6SHH-32	2"
LT6SHH-40	2 1/2"
LT6SHH-48	3"
LT6SHH-64	4"

Industrial Fittings



PART NUMBER		ANSI 150 lb ASME B16.5 FIXED FLANGE x INDUSTRIAL HOSETAIL
316 S/S	MILD STEEL	
AF36SIH-25-A1	AF3MSIH-25-A1	1"
AF36SIH-32-A1	AF3MSIH-32-A1	1 1/4"
AF36SIH-40-A1	AF3MSIH-40-A1	1 1/2"
AF36SIH-50-A1	AF3MSIH-50-A1	2"
AF36SIH-65-A1	AF3MSIH-65-A1	2 1/2"
AF36SIH-80-A1	AF3MSIH-80-A1	3"
AF36SIH-100-A1	AF3MSIH-100-A1	4"
AF36SIH-125-A1	AF3MSIH-125-A1	5"
AF36SIH-150-A1	AF3MSIH-150-A1	6"
AF36SIH-200-A1	AF3MSIH-200-A1	8"
AF36SIH-250-A1	AF3MSIH-250-A1	10"
AF36SIH-300-A1	AF3MSIH-300-A1	12"
AF36SIH-350-A1	AF3MSIH-350-A1	14"

* Also available in Floating Flanges



PART NUMBER		TAB 'E' AS2129 FIXED FLANGE x INDUSTRIAL HOSETAIL
316 S/S	MILD STEEL	
AF36SIH-25-E	AF3MSIH-25-E	1"
AF36SIH-32-E	AF3MSIH-32-E	1 1/4"
AF36SIH-40-E	AF3MSIH-40-E	1 1/2"
AF36SIH-50-E	AF3MSIH-50-E	2"
AF36SIH-65-E	AF3MSIH-65-E	2 1/2"
AF36SIH-80-E	AF3MSIH-80-E	3"
AF36SIH-100-E	AF3MSIH-100-E	4"
AF36SIH-125-E	AF3MSIH-125-E	5"
AF36SIH-150-E	AF3MSIH-150-E	6"
AF36SIH-200-E	AF3MSIH-200-E	8"
AF36SIH-250-E	AF3MSIH-250-E	10"
AF36SIH-300-E	AF3MSIH-300-E	12"
AF36SIH-350-E	AF3MSIH-350-E	14"

* Also available in Floating Flanges



PART NUMBER		EN 1092-1 DIN 16 FIXED FLANGE x INDUSTRIAL HOSETAIL
316 S/S	MILD STEEL	
AF36SIH-25-D16	AF3MSIH-25-D16	1"
AF36SIH-32-D16	AF3MSIH-32-D16	1 1/4"
AF36SIH-40-D16	AF3MSIH-40-D16	1 1/2"
AF36SIH-50-D16	AF3MSIH-50-D16	2"
AF36SIH-65-D16	AF3MSIH-65-D16	2 1/2"
AF36SIH-80-D16	AF3MSIH-80-D16	3"
AF36SIH-100-D16	AF3MSIH-100-D16	4"
AF36SIH-125-D16	AF3MSIH-125-D16	5"
AF36SIH-150-D16	AF3MSIH-150-D16	6"
AF36SIH-200-D16	AF3MSIH-200-D16	8"
AF36SIH-250-D16	AF3MSIH-250-D16	10"
AF36SIH-300-D16	AF3MSIH-300-D16	12"
AF36SIH-350-D16	AF3MSIH-350-D16	14"

Specialised Encapsulated Fittings Available on request.



Industrial Fittings

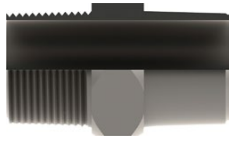

PART NUMBER	BSPT 150lb 316 S/S HEX MALE WELD ON
AF16SW-02-BT	1/8"
AF16SW-04-BT	1/4"
AF16SW-06-BT	3/8"
AF16SW-08-BT	1/2"
AF16SW-10-BT	5/8"
AF16SW-12-BT	3/4"
AF16SW-16-BT	1"
AF16SW-20-BT	1 1/4"
AF16SW-24-BT	1 1/2"
AF16SW-32-BT	2"
AF16SW-40-BT	2 1/2"
AF16SW-48-BT	3"
AF16SW-64-BT	4"

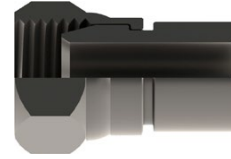

PART NUMBER	BSPP CONE SEAT 316 S/S FEMALE SWIVEL WELD ON
AF26SW-02-BPCS	1/8"
AF26SW-04-BPCS	1/4"
AF26SW-06-BPCS	3/8"
AF26SW-08-BPCS	1/2"
AF26SW-10-BPCS	5/8"
AF26SW-12-BPCS	3/4"
AF26SW-16-BPCS	1"
AF26SW-20-BPCS	1 1/4"
AF26SW-24-BPCS	1 1/2"
AF26SW-32-BPCS	2"
AF26SW-40-BPCS	2 1/2"
AF26SW-48-BPCS	3"
AF26SW-64-BPCS	4"



PART NUMBER	BSPP 150 lb 316 S/S 3 PIECE FEMALE/FEMALE BARREL UNION
AF126S-02-BP1	1/8"
AF126S-04-BP1	1/4"
AF126S-06-BP1	3/8"
AF126S-08-BP1	1/2"
AF126S-12-BP1	3/4"
AF126S-16-BP1	1"
AF126S-20-BP1	1 1/4"
AF126S-24-BP1	1 1/2"
AF126S-32-BP1	2"
AF126S-40-BP1	2 1/2"
AF126S-48-BP1	3"
AF126S-64-BP1	4"



PART NUMBER	BSPP X BSPT 150 lb 316 S/S 3 PIECE FEMALE/MALE BARREL UNION
AF116S-04-BP1	1/4"
AF116S-06-BP1	3/8"
AF116S-08-BP1	1/2"
AF116S-12-BP1	3/4"
AF116S-16-BP1	1"
AF116S-20-BP1	1 1/4"
AF116S-24-BP1	1 1/2"
AF116S-32-BP1	2"
AF116S-40-BP1	2 1/2"
AF116S-48-BP1	3"
AF116S-64-BP1	4"

Industrial Fittings

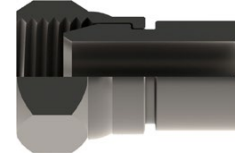
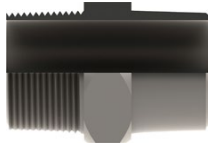

PART NUMBER	NPT 316 S/S 150lb HEX MALE WELD ON
AF16SW-02-NT1	1/8"
AF16SW-04-NT1	1/4"
AF16SW-06-NT1	3/8"
AF16SW-08-NT1	1/2"
AF16SW-10-NT1	5/8"
AF16SW-12-NT1	3/4"
AF16SW-16-NT1	1"
AF16SW-20-NT1	1 1/4"
AF16SW-24-NT1	1 1/2"
AF16SW-32-NT1	2"
AF16SW-40-NT1	2 1/2"
AF16SW-48-NT1	3"
AF16SW-64-NT1	4"

PART NUMBER	NPSM CONE SEAT 316 S/S FEMALE SWIVEL WELD ON
AF26SW-02-NMCS	1/8"
AF26SW-04-NMCS	1/4"
AF26SW-06-NMCS	3/8"
AF26SW-08-NMCS	1/2"
AF26SW-10-NMCS	5/8"
AF26SW-12-NMCS	3/4"
AF26SW-16-NMCS	1"
AF26SW-20-NMCS	1 1/4"
AF26SW-24-NMCS	1 1/2"
AF26SW-32-NMCS	2"



PART NUMBER	NPT 150 lb 316 S/S 3 PIECE FEMALE/FEMALE BARREL UNION
AF126S-02-NT1	1/8"
AF126S-04-NT1	1/4"
AF126S-06-NT1	3/8"
AF126S-08-NT1	1/2"
AF126S-12-NT1	3/4"
AF126S-16-NT1	1"
AF126S-20-NT1	1 1/4"
AF126S-24-NT1	1 1/2"
AF126S-32-NT1	2"
AF126S-40-NT1	2 1/2"
AF126S-48-NT1	3"
AF126S-64-NT1	4"

PART NUMBER	NPT X NPT 150 lb 316 S/S 3 PIECE FEMALE/MALE BARREL UNION
AF116S-04-NT1	1/4"
AF116S-06-NT1	3/8"
AF116S-08-NT1	1/2"
AF116S-12-NT1	3/4"
AF116S-16-NT1	1"
AF116S-20-NT1	1 1/4"
AF116S-24-NT1	1 1/2"
AF116S-32-NT1	2"
AF116S-40-NT1	2 1/2"
AF116S-48-NT1	3"
AF116S-64-NT1	4"

Industrial Fittings



PART NUMBER	JIC 316 S/S FEMALE SWIVEL WELD ON
AF26SW-07-JC	7/16"
AF26SW-09-JC	9/16"
AF26SW-12-JC	3/4"
AF26SW-14-JC	7/8"
AF26SW-17-JC	1 1/16"
AF26SW-21-JC	1 5/16"
AF26SW-26-JC	1 5/8"
AF26SW-30-JC	1 7/8"
AF26SW-40-JC	2 1/2"



PART NUMBER	316 S/S SHD 10 STUB END
ST6SP-12-S10	1/2"
ST6SP-20-S10	3/4"
ST6SP-25-S10	1"
ST6SP-32-S10	1 1/4"
ST6SP-40-S10	1 1/2"
ST6SP-50-S10	2"
ST6SP-65-S10	2 1/2"
ST6SP-80-S10	3"
ST6SP-100-S10	4"
ST6SP-150-S10	6"
ST6SP-200-S10	8"



PART NUMBER	316 S/S SHD 40 STUB END
ST6SP-12-S40	1/2"
ST6SP-20-S40	3/4"
ST6SP-25-S40	1"
ST6SP-32-S40	1 1/4"
ST6SP-40-S40	1 1/2"
ST6SP-50-S40	2"
ST6SP-65-S40	2 1/2"
ST6SP-80-S40	3"
ST6SP-100-S40	4"
ST6SP-150-S40	6"
ST6SP-200-S40	8"



PART NUMBER	INDUSTRIAL 316 S/S LIFESAVER TAIL (6000 kPa)
LT6SIH60-12	3/4"
LT6SIH60-16	1"
LT6SIH60-20	1 1/4"
LT6SIH60-24	1 1/2"
LT6SIH60-32	2"
LT6SIH60-40	2 1/2"
LT6SIH60-48	3"
LT6SIH60-64	4"
LT6SIH60-80	5"
LT6SIH60-96	6"
LT6SIH60-128	8"
LT6SIH60-160	10"
LT6SIH60-192	12"

Industrial Fittings

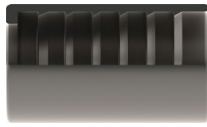

PART NUMBER	INDUSTRIAL 316 S/S FERRULE (6000 kPa)
IF6S60-12	3/4"
IF6S60-16	1"
IF6S60-20	1 1/4"
IF6S60-24	1 1/2"
IF6S60-32	2"
IF6S60-40	2 1/2"
IF6S60-48	3"
IF6S60-64	4"



PART NUMBER	INDUSTRIAL 304 S/S SLOTTED FERRULE (2000 kPa)	
	HOSE SIZE	FERRULE I.D. (mm)
IF4S20-31.8-12	3/4"	31.8
IF4S20-33.3-12	3/4"	33.3
IF4S20-34.9-12	3/4"	34.9
IF4S20-36.5-16	1"	36.5
IF4S20-38.1-16	1"	38.1
IF4S20-39.7-16	1"	39.7
IF4S20-44.5-20	1 1/4"	44.5
IF4S20-46-20	1 1/4"	46
IF4S20-46-24	1 1/2"	46
IF4S20-49.2-24	1 1/2"	49.2
IF4S20-50.8-24	1 1/2"	50.8
IF4S20-52.4-24	1 1/2"	52.4
IF4S20-63.5-32	2"	63.5
IF4S20-65.1-32	2"	65.1
IF4S20-66.7-32	2"	66.7
IF4S20-68.3-32	2"	68.3
IF4S20-76.2-40	2 1/2"	76.2
IF4S20-79.4-40	2 1/2"	79.4
IF4S20-90.5-48	3"	90.5
IF4S20-92.1-48	3"	92.1
IF4S20-93.7-48	3"	93.7
IF4S20-115.9-64	4"	115.9
IF4S20-119.1-64	4"	119.1
IF4S20-122.2-64	4"	122.2
IF4S20-168.3-96	6"	168.3
IF4S20-171.5-96	6"	171.5

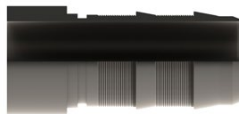

PART NUMBER	INDUSTRIAL 316 S/S LIFESAVER TAIL (2000 kPa)
LT6SIH20-16	1"
LT6SIH20-20	1 1/4"
LT6SIH20-24	1 1/2"
LT6SIH20-32	2"
LT6SIH20-40	2 1/2"
LT6SIH20-48	3"
LT6SIH20-64	4"
LT6SIH20-80	5"
LT6SIH20-96	6"
LT6SIH20-128	8"
LT6SIH20-160	10"
LT6SIH20-192	12"

Industrial Fittings

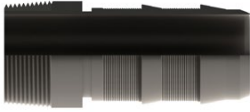

PART NUMBER	BSPT 316 S/S MALE x INDUSTRIAL HOSETAIL
AF56SIH20-1616-BT	1" x 1"
AF56SIH20-2020-BT	1 1/4" x 1 1/4"
AF56SIH20-2424-BT	1 1/2" x 1 1/2"
AF56SIH20-3232-BT	2" x 2"
AF56SIH20-4040-BT	2 1/2" x 2 1/2"
AF56SIH20-4848-BT	3"
AF56SIH20-9696-BT	4"



PART NUMBER	BSPP CONE SEAT 316 S/S FEMALE SWIVEL x INDUSTRIAL HOSETAIL
AF26SIH20-1616-BPCS	1" x 1"
AF26SIH20-2020-BPCS	1 1/4" x 1 1/4"
AF26SIH20-2424-BPCS	1 1/2" x 1 1/2"
AF26SIH20-3232-BPCS	2" x 2"
AF26SIH20-4040-BPCS	2 1/2" x 2 1/2"
AF26SIH20-4848-BPCS	3"
AF26SIH20-9696-BPCS	4"

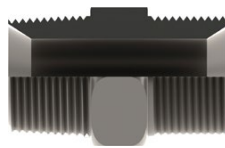

PART NUMBER	BSPT/P 150lb 316 S/S SEATED HEX MALE NIPPLE
HMN6S-2020-BT1SBP1S	1 1/4" x 1 1/4"
HMN6S-2424-BT1SBP1S	1 1/2" x 1 1/2"
HMN6S-3232-BT1SBP1S	2" x 2"

Industrial Fittings

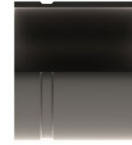
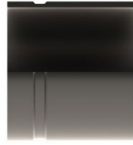

PART NUMBER	ROLLED GROOVE CARBON STEEL STD SPIGOT		
	SIZE	WALL THICKNESS (mm)	O.D. (mm)
RGMSW-25	1"	3.38	33.7
RGMSW-32	1 1/4"	3.56	42.4
RGMSW-40	1 1/2"	3.65	48.3
RGMSW-50	2"	3.91	60.3
RGMSW-65-US	2 1/2"	5.16	73.0
RGMSW-65	2 1/2"	5.16	76.1
RGMSW-80	3"	5.49	88.9
RGMSW-100	4"	6.02	114.3
RGMSW-125	5"	6.55	141.3
RGMSW-150	6"	7.11	165.1
RGMSW-150-US	6"	7.11	168.3
RGMSW-200	8"	8.18	219.1
RGMSW-250	10"	9.27	273.0
RGMSW-300	12"	10.31	323.9

PART NUMBER	ROLLED GROOVE 316 S/S SCH40 SPIGOT		
	SIZE	WALL THICKNESS (mm)	O.D. (mm)
RG6SW-25	1"	3.38	33.7
RG6SW-32	1 1/4"	3.56	42.4
RG6SW-40	1 1/2"	3.68	48.3
RG6SW-50	2"	3.91	60.3
RG6SW-65-US	2 1/2"	5.16	73.0
RG6SW-65	2 1/2"	5.16	76.1
RG6SW-80	3"	5.49	88.9
RG6SW-100	4"	6.02	114.3
RG6SW-125	5"	6.55	141.3
RG6SW-150	6"	7.11	165.1
RG6SW-150-US	6"	7.11	168.3
RG6SW-200	8"	8.18	219.1
RG6SW-250	10"	9.27	273.0
RG6SW-300	12"	9.53	323.9

Refer to specifications on page: 318

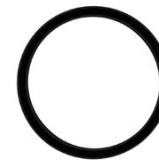

PART NUMBER	GALVANISED PAINTED ROLLED GROOVE RIGID COUPLING (2068 kPa)
RGCLAMP-25	1"
RGCLAMP-32	1 1/4"
RGCLAMP-40	1 1/2"
RGCLAMP-50	2"
RGCLAMP-65	2 1/2"
RGCLAMP-65US	2 1/2"
RGCLAMP-80	3"
RGCLAMP-100	4"
RGCLAMP-125	5"
RGCLAMP-150	6"
RGCLAMP-150-US	6"
RGCLAMP-200	8"
RGCLAMP-250	10"
RGCLAMP-300	12"

PART NUMBER		ROLLED GROOVE SEAL
NITRILE	EPDM	
RGsBN-25	RGSEPDM-25	1"
RGsBN-32	RGSEPDM-32	1 1/4"
RGsBN-40	RGSEPDM-40	1 1/2"
RGsBN-50	RGSEPDM-50	2"
RGsBN-65	RGSEPDM-65	2 1/2"
RGsBN-65-US	RGSEPDM-65-US	2 1/2"
RGsBN-80	RGSEPDM-80	3"
RGsBN-100	RGSEPDM-100	4"
RGsBN-125	RGSEPDM-125	5"
RGsBN-150	RGSEPDM-150	6"
RGsBN-150-US	RGSEPDM-150-US	6"
RGsBN-200	RGSEPDM-200	8"
RGsBN-250	RGSEPDM-250	10"
RGsBN-300	RGSEPDM-300	12"

Industrial Fittings

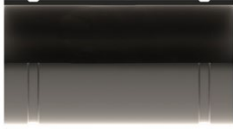

PART NUMBER	DOUBLE ROLLED GROOVE CARBON STEEL STD ADPATOR		
	SIZE	WALL THICKNESS (mm)	O.D. (mm)
RGDMS-25	1"	3.38	33.7
RGDMS-32	1 1/4"	3.56	42.4
RGDMS-40	1 1/2"	3.65	48.3
RGDMS-50	2"	3.91	60.3
RGDMS-65-US	2 1/2"	5.16	73.0
RGDMS-65	2 1/2"	5.16	76.1
RGDMS-80	3"	5.49	88.9
RGDMS-100	4"	6.02	114.3
RGDMS-125	5"	6.55	141.3
RGDMS-150	6"	7.11	165.1
RGDMS-150-US	6"	7.11	168.3
RGDMS-200	8"	8.18	219.1
RGDMS-250	10"	9.27	273.0
RGDMS-300	12"	10.31	323.9

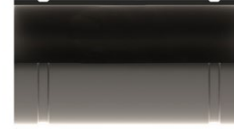

PART NUMBER	DOUBLE ROLLED GROOVE 316 S/S SCH40 ADPATOR		
	SIZE	WALL THICKNESS (mm)	O.D. (mm)
RGD6S-25	1"	3.38	33.7
RGD6S-32	1 1/4"	3.56	42.4
RGD6S-40	1 1/2"	3.68	48.3
RGD6S-50	2"	3.91	60.3
RGD6S-65-US	2 1/2"	5.16	73.0
RGD6S-65	2 1/2"	5.16	76.1
RGD6S-80	3"	5.49	88.9
RGD6S-100	4"	6.02	114.3
RGD6S-125	5"	6.55	141.3
RGD6S-150	6"	7.11	165.1
RGD6S-150-US	6"	7.11	168.3
RGD6S-200	8"	8.18	219.1
RGD6S-250	10"	9.27	273.0
RGD6S-300	12"	9.53	323.9

*Custom Adapters Available On Request

Industrial Fittings



PART NUMBER	TYPE 'E' 316 S/S MALE CAMLOCK x INDUSTRIAL HOSETAIL
QL16SIH-08	1/2"
QL16SIH-12	3/4"
QL16SIH-16	1"
QL16SIH-20	1 1/4"
QL16SIH-24	1 1/2"
QL16SIH-32	2"
QL16SIH-40	2 1/2"
QL16SIH-48	3"
QL16SIH-64	4"
QL16SIH-96	6"

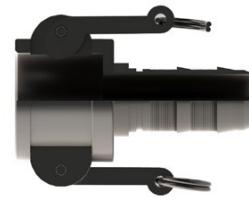

PART NUMBER	TYPE 'C' 316 S/S FEMALE CAMLOCK x INDUSTRIAL HOSETAIL (BN SEALS)
QL26SIH-08	1/2"
QL26SIH-12	3/4"
QL26SIH-16	1"
QL26SIH-20	1 1/4"
QL26SIH-24	1 1/2"
QL26SIH-32	2"
QL26SIH-40	2 1/2"
QL26SIH-48	3"
QL26SIH-64	4"
QL26SIH-96	6"



PART NUMBER	TYPE 'C' SAFLOK 316 S/S FEMALE CAMLOCK x INDUSTRIAL HOSETAIL (BN SEALS)
QL26SSAFIH-16	1"
QL26SSAFIH-24	1 1/2"
QL26SSAFIH-32	2"
QL26SSAFIH-40	2 1/2"
QL26SSAFIH-48	3"
QL26SSAFIH-64	4"



PART NUMBER	TYPE 'C' INSTA-LOCK 316 S/S FEMALE CAMLOCK x INDUSTRIAL HOSETAIL (BN SEALS)
QL26SINIH-08	1/2"
QL26SINIH-12	3/4"
QL26SINIH-16	1"
QL26SINIH-20	1 1/4"
QL26SINIH-24	1 1/2"
QL26SINIH-32	2"
QL26SINIH-40	2 1/2"
QL26SINIH-48	3"
QL26SINIH-64	4"
QL26SINIH-96	6"

Specialised Encapsulated Fittings Available on request.



Fittings for Composite Hose

QL2

Female Camlock

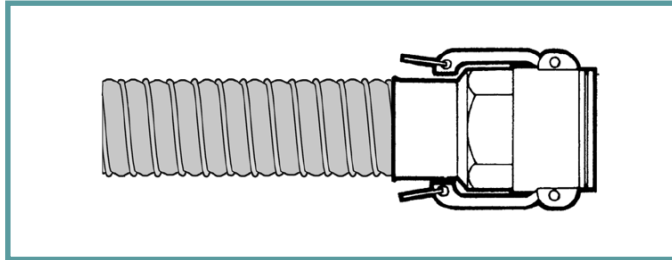

QL1

Male Camlock

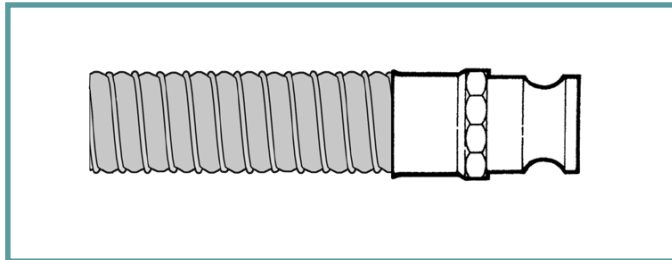

AF1

Fixed Male

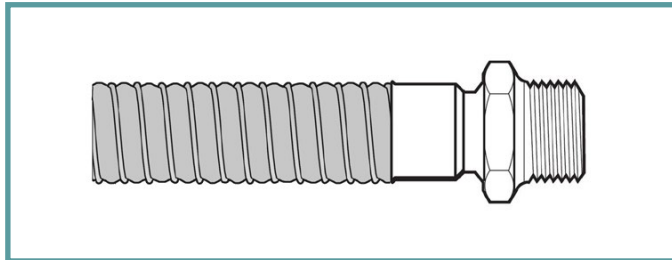

AF2

Swivel Female

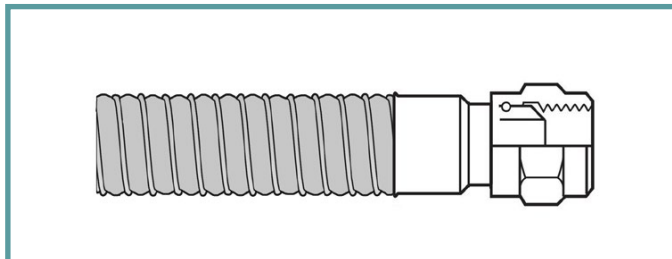

AF3

Fixed Flange

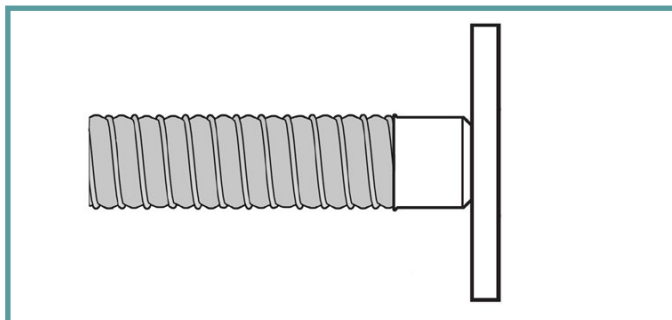

AF4

Floating Flange

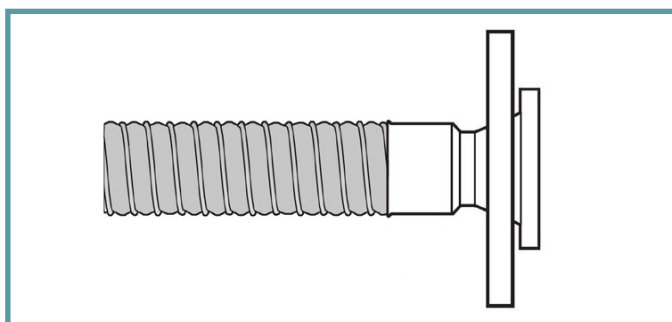

Composite Hose Fittings



TYPE 'E' 316 S/S MALE CAMLOCK x COMPOSITE HOSETAIL	
316 STAINLESS STEEL	
QL16SCH-16	1"
QL16SCH-20	1 1/4"
QL16SCH-24	1 1/2"
QL16SCH-32	2"
QL16SCH-40	2 1/2"
QL16SCH-48	3"
QL16SCH-64	4"
QL16SCH-96	6"
ALUMINIUM	
QL1ACH-16	1"
QL1ACH-20	1 1/4"
QL1ACH-24	1 1/2"
QL1ACH-32	2"
QL1ACH-40	2 1/2"
QL1ACH-48	3"
QL1ACH-64	4"
QL1ACH-96	6"

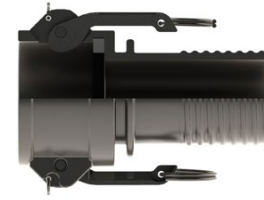

TYPE 'C' 316 S/S FEMALE CAMLOCK x COMPOSITE HOSETAIL (BN SEALS)	
316 STAINLESS STEEL	
QL26SCH-16	1"
QL26SCH-20	1 1/4"
QL26SCH-24	1 1/2"
QL26SCH-32	2"
QL26SCH-40	2 1/2"
QL26SCH-48	3"
QL26SCH-64	4"
QL26SCH-96	6"
ALUMINIUM	
QL2ACH-16	1"
QL2ACH-20	1 1/4"
QL2ACH-24	1 1/2"
QL2ACH-32	2"
QL2ACH-40	2 1/2"
QL2ACH-48	3"
QL2ACH-64	4"
QL2ACH-96	6"



TYPE 'C' SAFLOK 316 S/S FEMALE CAMLOCK x COMPOSITE HOSETAIL (BN SEALS)	
QL26SSAFCH-16	1"
QL26SSAFCH-20	1 1/4"
QL26SSAFCH-24	1 1/2"
QL26SSAFCH-32	2"
QL26SSAFCH-40	2 1/2"
QL26SSAFCH-48	3"
QL26SSAFCH-64	4"

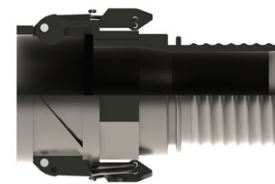

TYPE 'C' INSTA-LOCK 316 S/S FEMALE CAMLOCK x COMPOSITE HOSETAIL (BN SEALS)	
QL26SINCH-16	1"
QL26SINCH-20	1 1/4"
QL26SINCH-24	1 1/2"
QL26SINCH-32	2"
QL26SINCH-40	2 1/2"
QL26SINCH-48	3"
QL26SINCH-64	4"
QL26SINCH-96	6"

Composite Hose Fittings



PART NUMBER	ANSI 150 lb 316 FLANGE ASME B16.5 x COMPOSITE HOSETAIL
AF36SCH-25-A1	1"
AF36SCH-32-A1	1 1/4"
AF36SCH-40-A1	1 1/2"
AF36SCH-50-A1	2"
AF36SCH-65-A1	2 1/2"
AF36SCH-80-A1	3"
AF36SCH-100-A1	4"
AF36SCH-150-A1	6"
TAB 'E' 316 S/S FLANGE AS2129 x COMPOSITE HOSETAIL	
AF36SCH-25-E	1"
AF36SCH-32-E	1 1/4"
AF36SCH-40-E	1 1/2"
AF36SCH-50-E	2"
AF36SCH-65-E	2 1/2"
AF36SCH-80-E	3"
AF36SCH-100-E	4"
AF36SCH-150-E	6"



PART NUMBER	COMPOSITE HOSE FERRULE
304 STAINLESS STEEL	
CF4S-025	1"
CF4S-032	1 1/4"
CF4S-038	1 1/2"
CF4S-050	2"
CF4S-065	2 1/2"
CF4S-080	3"
CF4S-100	4"
CF4S-150	6"
ALUMINIUM	
CFAL-050	2"
CFAL-065	2 1/2"
CFAL-080	3"
CFAL-100	4"
CFAL-150	6"

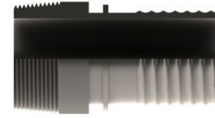

PART NUMBER	TYPE 'M' S/S 316 MALE BSPT x COMPOSITE HOSETAIL
SSCC-M025	1"
SSCC-M032	1 1/4"
SSCC-M038	1 1/2"
SSCC-M050	2"
SSCC-M065	2 1/2"
SSCC-M080	3"
SSCC-M100	4"
SSCC-M150	6"

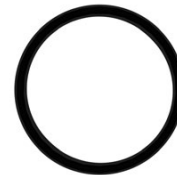

PART NUMBER	COMPOSITE CRIMP SEAL
NITRILE	
CC-SB025	1"
CC-SB032	1 1/4"
CC-SB040	1 1/2"
CC-SB050	2"
CC-SB065	2 1/2"
CC-SB080	3"
CC-SB100	4"
CC-SB150	6"
VITON	
CC-SV025	1"
CC-SV032	1 1/4"
CC-SV040	1 1/2"
CC-SV050	2"
CC-SV065	2 1/2"
CC-SV080	3"
CC-SV100	4"
CC-SV150	6"

PTFE Fittings

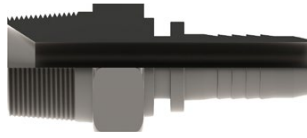

PART NUMBER	BSPT SEATED 316 S/S HEX MALE x PTFE HOSETAIL
AF16SPH-0202-BTS	1/8" x 1/8"
AF16SPH-0203-BTS	1/8" x 3/16"
AF16SPH-0204-BTS	1/8" x 1/4"
AF16SPH-0404-BTS	1/4" x 1/4"
AF16SPH-0405-BTS	1/4" x 5/16"
AF16SPH-0406-BTS	1/4" x 3/8"
AF16SPH-0604-BTS	3/8" x 1/4"
AF16SPH-0606-BTS	3/8" x 3/8"
AF16SPH-0608-BTS	3/8" x 1/2"
AF16SPH-0804-BTS	1/2" x 1/4"
AF16SPH-0806-BTS	1/2" x 3/8"
AF16SPH-0808-BTS	1/2" x 1/2"
AF16SPH-0812-BTS	1/2" x 3/4"
AF16SPH-0816-BTS	1/2" x 1"
AF16SPH-1206-BTS	3/4" x 3/8"
AF16SPH-1208-BTS	3/4" x 1/2"
AF16SPH-1212-BTS	3/4" x 3/4"
AF16SPH-1216-BTS	3/4" x 1"
AF16SPH-1608-BTS	1" x 1/2"
AF16SPH-1612-BTS	1" x 3/4"
AF16SPH-1616-BTS	1" x 1"
AF16SPH-1620-BTS	1" x 1 1/4"
AF16SPH-2016-BTS	1 1/4" x 1"
AF16SPH-2020-BTS	1 1/4" x 1 1/4"
AF16SPH-2024-BTS	1 1/4" x 1 1/2"
AF16SPH-2420-BTS	1 1/2" x 1 1/4"
AF16SPH-2424-BTS	1 1/2" x 1 1/2"
AF16SPH-2432-BTS	1 1/2" x 2"
AF16SPH-3220-BTS	2" x 1 1/4"
AF16SPH-3224-BTS	2" x 1 1/2"
AF16SPH-3232-BTS	2" x 2"

PART NUMBER	BSPP CONE SEAT 316 S/S FEMALE SWIVEL x PTFE HOSETAIL
AF26SPH-0202-BPCS	1/8" x 1/8"
AF26SPH-0203-BPCS	1/8" x 3/16"
AF26SPH-0204-BPCS	1/8" x 1/4"
AF26SPH-0403-BPCS	1/4" x 3/16"
AF26SPH-0404-BPCS	1/4" x 1/4"
AF26SPH-0406-BPCS	1/4" x 3/8"
AF26SPH-0604-BPCS	3/8" x 1/4"
AF26SPH-0606-BPCS	3/8" x 3/8"
AF26SPH-0608-BPCS	3/8" x 1/2"
AF26SPH-0804-BPCS	1/2" x 1/4"
AF26SPH-0806-BPCS	1/2" x 3/8"
AF26SPH-0808-BPCS	1/2" x 1/2"
AF26SPH-0812-BPCS	1/2" x 3/4"
AF26SPH-0816-BPCS	1/2" x 1"
AF26SPH-1206-BPCS	3/4" x 3/8"
AF26SPH-1208-BPCS	3/4" x 1/2"
AF26SPH-1212-BPCS	3/4" x 3/4"
AF26SPH-1216-BPCS	3/4" x 1"
AF26SPH-1608-BPCS	1" x 1/2"
AF26SPH-1612-BPCS	1" x 3/4"
AF26SPH-1616-BPCS	1" x 1"
AF26SPH-1620-BPCS	1" x 1 1/4"
AF26SPH-2016-BPCS	1 1/4" x 1"
AF26SPH-2020-BPCS	1 1/4" x 1 1/4"
AF26SPH-2024-BPCS	1 1/4" x 1 1/2"
AF26SPH-2420-BPCS	1 1/2" x 1 1/4"
AF26SPH-2424-BPCS	1 1/2" x 1 1/2"
AF26SPH-2432-BPCS	1 1/2" x 2"
AF26SPH-3220-BPCS	2" x 1 1/4"
AF26SPH-3224-BPCS	2" x 1 1/2"
AF26SPH-3232-BPCS	2" x 2"

PTFE Fittings



PART NUMBER	BSSP SEATED 316 S/S FEMALE SWIVEL x 90° SWEEP BEND x PTFE HOSETAIL
AF26S90PH-0202-BPS	1/8" x 1/8"
AF26S90PH-0203-BPS	1/8" x 3/16"
AF26S90PH-0204-BPS	1/8" x 1/4"
AF26S90PH-0403-BPS	1/4" x 3/16"
AF26S90PH-0404-BPS	1/4" x 1/4"
AF26S90PH-0406-BPS	1/4" x 3/8"
AF26S90PH-0604-BPS	3/8" x 1/4"
AF26S90PH-0606-BPS	3/8" x 3/8"
AF26S90PH-0608-BPS	3/8" x 1/2"
AF26S90PH-0804-BPS	1/2" x 1/4"
AF26S90PH-0806-BPS	1/2" x 3/8"
AF26S90PH-0808-BPS	1/2" x 1/2"
AF26S90PH-0812-BPS	1/2" x 3/4"
AF26S90PH-0816-BPS	1/2" x 1"
AF26S90PH-1206-BPS	3/4" x 3/8"
AF26S90PH-1208-BPS	3/4" x 1/2"
AF26S90PH-1212-BPS	3/4" x 3/4"
AF26S90PH-1216-BPS	3/4" x 1"
AF26S90PH-1608-BPS	1" x 1/2"
AF26S90PH-1612-BPS	1" x 3/4"
AF26S90PH-1616-BPS	1" x 1"
AF26S90PH-1620-BPS	1" x 1 1/4"
AF26S90PH-2016-BPS	1 1/4" x 1"
AF26S90PH-2020-BPS	1 1/4" x 1 1/4"
AF26S90PH-2024-BPS	1 1/4" x 1 1/2"
AF26S90PH-2420-BPS	1 1/2" x 1 1/4"
AF26S90PH-2424-BPS	1 1/2" x 1 1/2"
AF26S90PH-2432-BPS	1 1/2" x 2"
AF26S90PH-3220-BPS	2" x 1 1/4"
AF26S90PH-3224-BPS	2" x 1 1/2"
AF26S90PH-3232-BPS	2" x 2"



PART NUMBER	BSSP SEATED 316 S/S FEMALE SWIVEL x 45° SWEEP BEND x PTFE HOSETAIL
AF26S45PH-0202-BPS	1/8" x 1/8"
AF26S45PH-0203-BPS	1/8" x 3/16"
AF26S45PH-0204-BPS	1/8" x 1/4"
AF26S45PH-0403-BPS	1/4" x 3/16"
AF26S45PH-0404-BPS	1/4" x 1/4"
AF26S45PH-0406-BPS	1/4" x 3/8"
AF26S45PH-0604-BPS	3/8" x 1/4"
AF26S45PH-0606-BPS	3/8" x 3/8"
AF26S45PH-0608-BPS	3/8" x 1/2"
AF26S45PH-0804-BPS	1/2" x 1/4"
AF26S45PH-0806-BPS	1/2" x 3/8"
AF26S45PH-0808-BPS	1/2" x 1/2"
AF26S45PH-0812-BPS	1/2" x 3/4"
AF26S45PH-0816-BPS	1/2" x 1"
AF26S45PH-1206-BPS	3/4" x 3/8"
AF26S45PH-1208-BPS	3/4" x 1/2"
AF26S45PH-1212-BPS	3/4" x 3/4"
AF26S45PH-1216-BPS	3/4" x 1"
AF26S45PH-1608-BPS	1" x 1/2"
AF26S45PH-1612-BPS	1" x 3/4"
AF26S45PH-1616-BPS	1" x 1"
AF26S45PH-1620-BPS	1" x 1 1/4"
AF26S45PH-2016-BPS	1 1/4" x 1"
AF26S45PH-2020-BPS	1 1/4" x 1 1/4"
AF26S45PH-2024-BPS	1 1/4" x 1 1/2"
AF26S45PH-2420-BPS	1 1/2" x 1 1/4"
AF26S45PH-2424-BPS	1 1/2" x 1 1/2"
AF26S45PH-2432-BPS	1 1/2" x 2"
AF26S45PH-3220-BPS	2" x 1 1/4"
AF26S45PH-3224-BPS	2" x 1 1/2"
AF26S45PH-3232-BPS	2" x 2"

PTFE Fittings

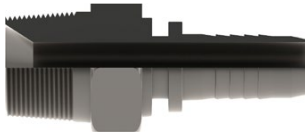

PART NUMBER	NPT SEATED 316 S/S HEX MALE x PTFE HOSETAIL
AF16SPH-0202-NTS	1/8" x 1/8"
AF16SPH-0203-NTS	1/8" x 3/16"
AF16SPH-0204-NTS	1/8" x 1/4"
AF16SPH-0404-NTS	1/4" x 1/4"
AF16SPH-0406-NTS	1/4" x 3/8"
AF16SPH-0604-NTS	3/8" x 1/4"
AF16SPH-0606-NTS	3/8" x 3/8"
AF16SPH-0608-NTS	3/8" x 1/2"
AF16SPH-0804-NTS	1/2" x 1/4"
AF16SPH-0806-NTS	1/2" x 3/8"
AF16SPH-0808-NTS	1/2" x 1/2"
AF16SPH-0812-NTS	1/2" x 3/4"
AF16SPH-0816-NTS	1/2" x 1"
AF16SPH-1206-NTS	3/4" x 3/8"
AF16SPH-1208-NTS	3/4" x 1/2"
AF16SPH-1212-NTS	3/4" x 3/4"
AF16SPH-1216-NTS	3/4" x 1"
AF16SPH-1608-NTS	1" x 1/2"
AF16SPH-1612-NTS	1" x 3/4"
AF16SPH-1616-NTS	1" x 1"
AF16SPH-1620-NTS	1" x 1 1/4"
AF16SPH-2016-NTS	1 1/4" x 1"
AF16SPH-2020-NTS	1 1/4" x 1 1/4"
AF16SPH-2024-NTS	1 1/4" x 1 1/2"
AF16SPH-2420-NTS	1 1/2" x 1 1/4"
AF16SPH-2424-NTS	1 1/2" x 1 1/2"
AF16SPH-2432-NTS	1 1/2" x 2"
AF16SPH-3220-NTS	2" x 1 1/4"
AF16SPH-3224-NTS	2" x 1 1/2"
AF16SPH-3232-NTS	2" x 2"

PART NUMBER	NPSM CONE SEAT 316 S/S FEMALE SWIVEL x HYDRAULIC HOSETAIL
AF26SPH-0202-NMCS	1/8" x 1/8"
AF26SPH-0203-NMCS	1/8" x 3/16"
AF26SPH-0204-NMCS	1/8" x 1/4"
AF26SPH-0404-NMCS	1/4" x 1/4"
AF26SPH-0406-NMCS	1/4" x 3/8"
AF26SPH-0604-NMCS	3/8" x 1/4"
AF26SPH-0606-NMCS	3/8" x 3/8"
AF26SPH-0608-NMCS	3/8" x 1/2"
AF26SPH-0804-NMCS	1/2" x 1/4"
AF26SPH-0806-NMCS	1/2" x 3/8"
AF26SPH-0808-NMCS	1/2" x 1/2"
AF26SPH-0812-NMCS	1/2" x 3/4"
AF26SPH-0816-NMCS	1/2" x 1"
AF26SPH-1206-NMCS	3/4" x 3/8"
AF26SPH-1208-NMCS	3/4" x 1/2"
AF26SPH-1212-NMCS	3/4" x 3/4"
AF26SPH-1216-NMCS	3/4" x 1"
AF26SPH-1608-NMCS	1" x 1/2"
AF26SPH-1612-NMCS	1" x 3/4"
AF26SPH-1616-NMCS	1" x 1"
AF26SPH-1620-NMCS	1" x 1 1/4"
AF26SPH-2016-NMCS	1 1/4" x 1"
AF26SPH-2020-NMCS	1 1/4" x 1 1/4"
AF26SPH-2024-NMCS	1 1/4" x 1 1/2"
AF26SPH-2420-NMCS	1 1/2" x 1 1/4"
AF26SPH-2424-NMCS	1 1/2" x 1 1/2"
AF26SPH-2432-NMCS	1 1/2" x 2"
AF26SPH-3220-NMCS	2" x 1 1/4"
AF26SPH-3224-NMCS	2" x 1 1/2"
AF26SPH-3232-NMCS	2" x 2"

Specialised Encapsulated Fittings Available on request.

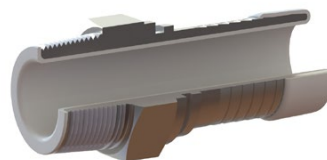

PTFE Fittings



PART NUMBER	NPSM CONE SEAT 316 S/S FEMALE SWIVEL x 90° SWEPT BEND x PTFE HOSETAIL
AF26S90PH-0202-NMCS	1/8" x 1/8"
AF26S90PH-0203-NMCS	1/8" x 3/16"
AF26S90PH-0204-NMCS	1/8" x 1/4"
AF26S90PH-0404-NMCS	1/4" x 1/4"
AF26S90PH-0406-NMCS	1/4" x 3/8"
AF26S90PH-0604-NMCS	3/8" x 1/4"
AF26S90PH-0606-NMCS	3/8" x 3/8"
AF26S90PH-0608-NMCS	3/8" x 1/2"
AF26S90PH-0804-NMCS	1/2" x 1/4"
AF26S90PH-0806-NMCS	1/2" x 3/8"
AF26S90PH-0808-NMCS	1/2" x 1/2"
AF26S90PH-0812-NMCS	1/2" x 3/4"
AF26S90PH-0816-NMCS	1/2" x 1"
AF26S90PH-1206-NMCS	3/4" x 3/8"
AF26S90PH-1208-NMCS	3/4" x 1/2"
AF26S90PH-1212-NMCS	3/4" x 3/4"
AF26S90PH-1216-NMCS	3/4" x 1"
AF26S90PH-1608-NMCS	1" x 1/2"
AF26S90PH-1612-NMCS	1" x 3/4"
AF26S90PH-1616-NMCS	1" x 1"
AF26S90PH-1620-NMCS	1" x 1 1/4"
AF26S90PH-2016-NMCS	1 1/4" x 1"
AF26S90PH-2020-NMCS	1 1/4" x 1 1/4"
AF26S90PH-2024-NMCS	1 1/4" x 1 1/2"
AF26S90PH-2420-NMCS	1 1/2" x 1 1/4"
AF26S90PH-2424-NMCS	1 1/2" x 1 1/2"
AF26S90PH-2432-NMCS	1 1/2" x 2"
AF26S90PH-3220-NMCS	2" x 1 1/4"
AF26S90PH-3224-NMCS	2" x 1 1/2"
AF26S90PH-3232-NMCS	2" x 2"

PART NUMBER	NPSM CONE SEAT 316 S/S FEMALE SWIVEL x 45° SWEPT BEND x PTFE HOSETAIL
AF26S45PH-0202-NMCS	1/8" x 1/8"
AF26S45PH-0203-NMCS	1/8" x 3/16"
AF26S45PH-0204-NMCS	1/8" x 1/4"
AF26S45PH-0404-NMCS	1/4" x 1/4"
AF26S45PH-0406-NMCS	1/4" x 3/8"
AF26S45PH-0604-NMCS	3/8" x 1/4"
AF26S45PH-0606-NMCS	3/8" x 3/8"
AF26S45PH-0608-NMCS	3/8" x 1/2"
AF26S45PH-0804-NMCS	1/2" x 1/4"
AF26S45PH-0806-NMCS	1/2" x 3/8"
AF26S45PH-0808-NMCS	1/2" x 1/2"
AF26S45PH-0812-NMCS	1/2" x 3/4"
AF26S45PH-0816-NMCS	1/2" x 1"
AF26S45PH-1206-NMCS	3/4" x 3/8"
AF26S45PH-1208-NMCS	3/4" x 1/2"
AF26S45PH-1212-NMCS	3/4" x 3/4"
AF26S45PH-1216-NMCS	3/4" x 1"
AF26S45PH-1608-NMCS	1" x 1/2"
AF26S45PH-1612-NMCS	1" x 3/4"
AF26S45PH-1616-NMCS	1" x 1"
AF26S45PH-1620-NMCS	1" x 1 1/4"
AF26S45PH-2016-NMCS	1 1/4" x 1"
AF26S45PH-2020-NMCS	1 1/4" x 1 1/4"
AF26S45PH-2024-NMCS	1 1/4" x 1 1/2"
AF26S45PH-2420-NMCS	1 1/2" x 1 1/4"
AF26S45PH-2424-NMCS	1 1/2" x 1 1/2"
AF26S45PH-2432-NMCS	1 1/2" x 2"
AF26S45PH-3220-NMCS	2" x 1 1/4"
AF26S45PH-3224-NMCS	2" x 1 1/2"
AF26S45PH-3232-NMCS	2" x 2"

PTFE Fittings



PART NUMBER	JIC 316 S/S HEX MALE x PTFE HOSETAIL
AF16SPH-0702-JC	7/16" x 1/8"
AF16SPH-0703-JC	7/16" x 3/16"
AF16SPH-0704-JC	7/16" x 1/4"
AF16SPH-0706-JC	7/16" x 3/8"
AF16SPH-0904-JC	9/16" x 1/4"
AF16SPH-0906-JC	9/16" x 3/8"
AF16SPH-0908-JC	9/16" x 1/2"
AF16SPH-1204-JC	3/4" x 1/4"
AF16SPH-1206-JC	3/4" x 3/8"
AF16SPH-1208-JC	3/4" x 1/2"
AF16SPH-1210-JC	3/4" x 5/8"
AF16SPH-1406-JC	7/8" x 3/8"
AF16SPH-1408-JC	7/8" x 1/2"
AF16SPH-1410-JC	7/8" x 5/8"
AF16SPH-1412-JC	7/8" x 3/4"
AF16SPH-1710-JC	1 1/16" x 5/8"
AF16SPH-1712-JC	1 1/16" x 3/4"
AF16SPH-1716-JC	1 1/16" x 1"
AF16SPH-1912-JC	1 3/16" x 3/4"
AF16SPH-1916-JC	1 3/16" x 1"
AF16SPH-2112-JC	1 5/16" x 3/4"
AF16SPH-2116-JC	1 5/16" x 1"
AF16SPH-2120-JC	1 5/16" x 1 1/4"
AF16SPH-2616-JC	1 5/8" x 1"
AF16SPH-2620-JC	1 5/8" x 1 1/4"
AF16SPH-3020-JC	1 7/8" x 1 1/4"
AF16SPH-3024-JC	1 7/8" x 1 1/2"
AF16SPH-3032-JC	1 7/8" x 2"
AF16SPH-4024-JC	2 1/2" x 1 1/2"
AF16SPH-4032-JC	2 1/2" x 2"

PART NUMBER	JIC 316 S/S FEMALE SWIVEL x PTFE HOSETAIL
AF26SPH-0702-JC	7/16" x 1/8"
AF26SPH-0703-JC	7/16" x 3/16"
AF26SPH-0704-JC	7/16" x 1/4"
AF26SPH-0706-JC	7/16" x 3/8"
AF26SPH-0904-JC	9/16" x 1/4"
AF26SPH-0906-JC	9/16" x 3/8"
AF26SPH-0908-JC	9/16" x 1/2"
AF26SPH-1204-JC	3/4" x 1/4"
AF26SPH-1206-JC	3/4" x 3/8"
AF26SPH-1208-JC	3/4" x 1/2"
AF26SPH-1210-JC	3/4" x 5/8"
AF26SPH-1406-JC	7/8" x 3/8"
AF26SPH-1408-JC	7/8" x 1/2"
AF26SPH-1410-JC	7/8" x 5/8"
AF26SPH-1412-JC	7/8" x 3/4"
AF26SPH-1710-JC	1 1/16" x 5/8"
AF26SPH-1712-JC	1 1/16" x 3/4"
AF26SPH-1716-JC	1 1/16" x 1"
AF26SPH-1912-JC	1 3/16" x 3/4"
AF26SPH-1916-JC	1 3/16" x 1"
AF26SPH-2112-JC	1 5/16" x 3/4"
AF26SPH-2116-JC	1 5/16" x 1"
AF26SPH-2120-JC	1 5/16" x 1 1/4"
AF26SPH-2616-JC	1 5/8" x 1"
AF26SPH-2620-JC	1 5/8" x 1 1/4"
AF26SPH-3020-JC	1 7/8" x 1 1/4"
AF26SPH-3024-JC	1 7/8" x 1 1/2"
AF26SPH-3032-JC	1 7/8" x 2"
AF26SPH-4024-JC	2 1/2" x 1 1/2"
AF26SPH-4032-JC	2 1/2" x 2"

Specialised Encapsulated Fittings Available on request.

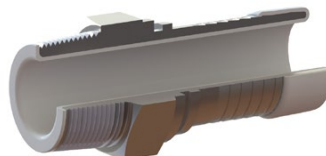

PTFE Fittings



PART NUMBER	JIC 316 S/S FEMALE SWIVEL x 90° SWEEP BEND x PTFE HOSETAIL
AF26S90PH-0702-JC	7/16" x 1/8"
AF26S90HH-0703-JC	7/16" x 3/16"
AF26S90PH-0704-JC	7/16" x 1/4"
AF26S90PH-0706-JC	7/16" x 3/8"
AF26S90PH-0904-JC	9/16" x 1/4"
AF26S90PH-0906-JC	9/16" x 3/8"
AF26S90PH-0908-JC	9/16" x 1/2"
AF26S90PH-1204-JC	3/4" x 1/4"
AF26S90PH-1206-JC	3/4" x 3/8"
AF26S90PH-1208-JC	3/4" x 1/2"
AF26S90PH-1210-JC	3/4" x 5/8"
AF26S90PH-1406-JC	7/8" x 3/8"
AF26S90PH-1408-JC	7/8" x 1/2"
AF26S90PH-1410-JC	7/8" x 5/8"
AF26S90PH-1412-JC	7/8" x 3/4"
AF26S90PH-1710-JC	1 1/16" x 5/8"
AF26S90PH-1712-JC	1 1/16" x 3/4"
AF26S90PH-1716-JC	1 1/16" x 1"
AF26S90PH-1912-JC	1 3/16" x 3/4"
AF26S90PH-1916-JC	1 3/16" x 1"
AF26S90PH-2112-JC	1 5/16" x 3/4"
AF26S90PH-2116-JC	1 5/16" x 1"
AF26S90PH-2120-JC	1 5/16" x 1 1/4"
AF26S90PH-2616-JC	1 5/8" x 1"
AF26S90PH-2620-JC	1 5/8" x 1 1/4"
AF26S90PH-3020-JC	1 7/8" x 1 1/4"
AF26S90PH-3024-JC	1 7/8" x 1 1/2"
AF26S90PH-3032-JC	1 7/8" x 2"
AF26S90PH-4024-JC	2 1/2" x 1 1/2"
AF26S90PH-4032-JC	2 1/2" x 2"

PART NUMBER	JIC 316 S/S FEMALE SWIVEL x 45° SWEEP BEND x PTFE HOSETAIL
AF26S45PH-0702-JC	7/16" x 1/8"
AF26S45PH-0703-JC	7/16" x 3/16"
AF26S45PH-0704-JC	7/16" x 1/4"
AF26S45PH-0706-JC	7/16" x 3/8"
AF26S45PH-0904-JC	9/16" x 1/4"
AF26S45PH-0906-JC	9/16" x 3/8"
AF26S45PH-0908-JC	9/16" x 1/2"
AF26S45PH-1204-JC	3/4" x 1/4"
AF26S45PH-1206-JC	3/4" x 3/8"
AF26S45PH-1208-JC	3/4" x 1/2"
AF26S45PH-1210-JC	3/4" x 5/8"
AF26S45PH-1406-JC	7/8" x 3/8"
AF26S45PH-1408-JC	7/8" x 1/2"
AF26S45PH-1410-JC	7/8" x 5/8"
AF26S45PH-1412-JC	7/8" x 3/4"
AF26S45PH-1710-JC	1 1/16" x 5/8"
AF26S45PH-1712-JC	1 1/16" x 3/4"
AF26S45PH-1716-JC	1 1/16" x 1"
AF26S45PH-1912-JC	1 3/16" x 3/4"
AF26S45PH-1916-JC	1 3/16" x 1"
AF26S45PH-2112-JC	1 5/16" x 3/4"
AF26S45PH-2116-JC	1 5/16" x 1"
AF26S45PH-2120-JC	1 5/16" x 1 1/4"
AF26S45PH-2616-JC	1 5/8" x 1"
AF26S45PH-2620-JC	1 5/8" x 1 1/4"
AF26S45PH-3020-JC	1 7/8" x 1 1/4"
AF26S45PH-3024-JC	1 7/8" x 1 1/2"
AF26S45PH-3032-JC	1 7/8" x 2"
AF26S45PH-4024-JC	2 1/2" x 1 1/2"
AF26S45PH-4032-JC	2 1/2" x 2"

PTFE Fittings

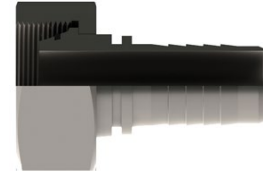
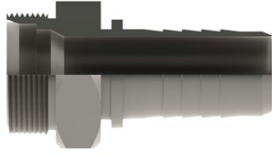

PART NUMBER	METRIC LIGHT DKL MALE 316 S/S x PTFE HOSETAIL	TUBE SIZE (mm)
AF16SPH-1215-04-DKL	M12 x 1.5 x 1/4"	6 L
AF16SPH-1415-04-DKL	M14 x 1.5 x 1/4"	8 L
AF16SPH-1615-04-DKL	M16 x 1.5 x 1/4"	10 L
AF16SPH-1615-06-DKL	M16 x 1.5 x 3/8"	10 L
AF16SPH-1815-06-DKL	M18 x 1.5 x 3/8"	12 L
AF16SPH-2215-06-DKL	M22 x 1.5 x 3/8"	15 L
AF16SPH-2215-08-DKL	M22 x 1.5 x 1/2"	15 L
AF16SPH-2615-08-DKL	M26 x 1.5 x 1/2"	18 L
AF16SPH-3015-10-DKL	M30 x 1.5 x 5/8"	22 L
AF16SPH-3020-12-DKL	M30 x 2.0 x 3/4"	22 L
AF16SPH-3620-12-DKL	M36 x 2.0 x 3/4"	28 L
AF16SPH-3620-16-DKL	M36 x 2.0 x 1"	28 L
AF16SPH-4520-20-DKL	M45 x 2.0 x 1 1/4"	35 L
AF16SPH-5220-24-DKL	M52 x 2.0 x 1 1/2"	42 L

PART NUMBER	METRIC LIGHT DKL FEMALE 316 S/S x PTFE HOSETAIL	TUBE SIZE (mm)
AF26SPH-1215-04-DKL	M12 x 1.5 x 1/4"	6 L
AF26SPH-1415-04-DKL	M14 x 1.5 x 1/4"	8 L
AF26SPH-1615-04-DKL	M16 x 1.5 x 1/4"	10 L
AF26SPH-1815-04-DKL	M18 x 1.5 x 1/4"	12 L
AF26SPH-1615-05-DKL	M16 x 1.5 x 5/16"	10 L
AF26SPH-1815-05-DKL	M18 x 1.5 x 5/16"	12 L
AF26SPH-1615-06-DKL	M16 x 1.5 x 3/8"	10 L
AF26SPH-1815-06-DKL	M18 x 1.5 x 3/8"	12 L
AF26SPH-2215-06-DKL	M22 x 1.5 x 3/8"	15 L
AF26SPH-2215-08-DKL	M22 x 1.5 x 1/2"	15 L
AF26SPH-2615-08-DKL	M26 x 1.5 x 1/2"	18 L
AF26SPH-2615-10-DKL	M26 x 1.5 x 5/8"	18 L
AF26SPH-2615-12-DKL	M26 x 1.5 x 3/4"	18 L
AF26SPH-3020-12-DKL	M30 x 2.0 x 3/4"	22 L
AF26SPH-3620-12-DKL	M36 x 2.0 x 3/4"	28 L
AF26SPH-3620-16-DKL	M36 x 2.0 x 1"	28 L
AF26SPH-4520-20-DKL	M45 x 2.0 x 1 1/4"	35 L
AF26SPH-5220-24-DKL	M52 x 2.0 x 1 1/2"	42 L

PTFE Fittings

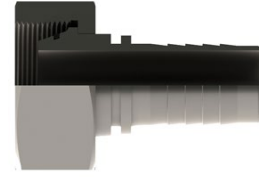
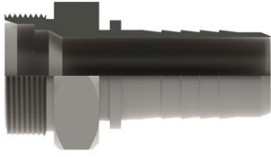

PART NUMBER	METRIC HEAVY DKS MALE 316 S/S x PTFE HOSETAIL	TUBE SIZE (mm)
AF16SPH-1615-04-DKS	M16 x 1.5 x 1/4"	8 S
AF16SPH-1815-04-DKS	M18 x 1.5 x 1/4"	10 S
AF16SPH-2015-05-DKS	M20 x 1.5 x 5/16"	12 S
AF16SPH-2015-06-DKS	M20 x 1.5 x 3/8"	12 S
AF16SPH-2215-06-DKS	M22 x 1.5 x 3/8"	14 S
AF16SPH-2415-08-DKS	M24 x 1.5 x 1/2"	16 S
AF16SPH-3020-10-DKS	M30 x 2.0 x 5/8"	20 S
AF16SPH-3020-12-DKS	M30 x 2.0 x 3/4"	20 S
AF16SPH-3620-12-DKS	M36 x 2.0 x 3/4"	25 S
AF16SPH-3620-16-DKS	M36 x 2.0 x 1"	30 S
AF16SPH-5220-20-DKS	M52 x 2.0 x 1 1/4"	38 S

PART NUMBER	METRIC HEAVY DKS FEMALE 316 S/S x PTFE HOSETAIL	TUBE SIZE (mm)
AF26SPH-1615-04-DKS	M16 x 1.5 x 1/4"	8 S
AF26SPH-1815-04-DKS	M18 x 1.5 x 1/4"	10 S
AF26SPH-2015-05-DKS	M20 x 1.5 x 5/16"	12 S
AF26SPH-2015-06-DKS	M20 x 1.5 x 3/8"	12 S
AF26SPH-2215-06-DKS	M22 x 1.5 x 3/8"	14 S
AF26SPH-2415-08-DKS	M24 x 1.5 x 1/2"	16 S
AF26SPH-3020-10-DKS	M30 x 2.0 x 5/8"	20 S
AF26PHH-3020-12-DKS	M36 x 2.0 x 3/4"	25 S
AF26SPH-4220-16-DKS	M42 x 2.0 x 1"	30 S
AF26SPH-5220-20-DKS	M52 x 2.0 x 1 1/4"	38 S

PTFE Fittings



PART NUMBER	STANDPIPE 316 S/S x PTFE HOSETAIL (IMPERIAL)
AF106SPH-I-0202	1/8" x 1/8"
AF106SPH-I-0203	1/8" x 3/16"
AF106SPH-I-0204	1/8" x 1/4"
AF106SPH-I-0303	3/16" x 3/16"
AF106SPH-I-0304	3/16" x 1/4"
AF106SPH-I-0402	1/4" x 1/8"
AF106SPH-I-0403	1/4" x 3/16"
AF106SPH-I-0404	1/4" x 1/4"
AF106SPH-I-0406	1/4" x 3/8"
AF106SPH-I-0408	1/4" x 1/2"
AF106SPH-I-0604	3/8" x 1/4"
AF106SPH-I-0606	3/8" x 3/8"
AF106SPH-I-0608	3/8" x 1/2"
AF106SPH-I-0806	1/2" x 3/8"
AF106SPH-I-0808	1/2" x 1/2"
AF106SPH-I-0810	1/2" x 5/8"
AF106SPH-I-0812	1/2" x 3/4"
AF106SPH-I-1008	5/8" x 1/2"
AF106SPH-I-1010	5/8" x 5/8"
AF106SPH-I-1012	5/8" x 3/4"
AF106SPH-I-1208	1/2" x 3/4"
AF106SPH-I-1210	3/4" x 5/8"
AF106SPH-I-1212	3/4" x 3/4"
AF106SPH-I-1216	3/4" x 1"
AF106SPH-I-1612	1" x 3/4"
AF106SPH-I-1616	1" x 1"
AF106SPH-I-2020	1 1/4" x 1 1/4"
AF106SPH-I-2424	1 1/2" x 1 1/2"
AF106SPH-I-3232	2" x 2"

PART NUMBER	STANDPIPE 316 S/S x PTFE HOSETAIL (METRIC)
AF106SPH-M-0202	3mm x 1/8"
AF106SPH-M-0303	4mm x 3/16"
AF106SPH-M-0404	6mm x 1/4"
AF106SPH-M-0606	10mm x 3/8"
AF106SPH-M-0808	12mm x 1/2"
AF106SPH-M-1010	15mm x 5/8"
AF106SPH-M-1212	20mm x 3/4"
AF106SPH-M-1616	25mm x 1"
AF106SPH-M-2020	32mm x 1 1/4"



PART NUMBER	PTFE 316 S/S LIFESAVER TAIL
LT6SPH-02	1/8"
LT6SPH-03	3/16"
LT6SPH-04	1/4"
LT6SPH-05	5/16"
LT6SPH-06	3/8"
LT6SPH-08	1/2"
LT6SPH-10	5/8"
LT6SPH-12	3/4"
LT6SPH-16	1"
LT6SPH-20	1 1/4"
LT6SPH-24	1 1/2"
LT6SPH-32	2"
LT6SPH-40	2 1/2"
LT6SPH-48	3"
LT6SPH-64	4"
LT6SPH-80	5"
LT6SPH-96	6"

PTFE Fittings



PART NUMBER	PTFE UNIVERSAL 316 S/S FERRULE
PUF6S-02	1/8"
PUF6S-03	3/16"
PUF6S-04	1/4"
PUF6S-05	5/16"
PUF6S-06	3/8"
PUF6S-08	1/2"
PUF6S-10	5/8"
PUF6S-12	3/4"
PUF6S-16	1"
PUF6S-20	1 1/4"
PUF6S-24	1 1/2"
PUF6S-32	2"
PUF6S-40	2 1/2"
PUF6S-48	3"
PUF6S-64	4"



PART NUMBER	PTFE ZINC PLATED FERRULE
SMFZP-2424	1 1/2"
SMFZP-3232	2"

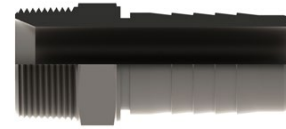

PART NUMBER	BSPT SEATED M/S ZINC PLATED FIXED MALE x PTFE HOSETAIL
AF1ZPPHFM-2424-BTS	1 1/2"
AF1ZPPHFM-3232-BTS	2"

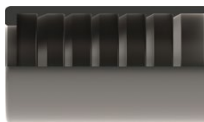

PART NUMBER	PTFE SAE 100 R14 316 S/S FERRULE
R14F6S-02	1/8"
R14F6S-03	3/16"
R14F6S-04	1/4"
R14F6S-05	5/16"
R14F6S-06	3/8"
R14F6S-08	1/2"
R14F6S-10	5/8"
R14F6S-12	3/4"
R14F6S-16	1"

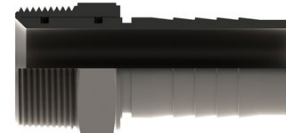

PART NUMBER	BSPT SEATED M/S ZINC PLATED SWIVEL MALE x PTFE HOSETAIL C/W VITON 'O' SEAL
AF1ZPPHSM-2424-BTS	1 1/2"
AF1ZPPHSM-3232-BTS	2"

PTFE Fittings



PART NUMBER	ANSI 150 lb 316 S/S FLANGE ASME B16.5 x PTFE HOSETAIL
AF36SPH-25-A1	1"
AF36SPH-32-A1	1 1/4"
AF36SPH-40-A1	1 1/2"
AF36SPH-50-A1	2"
AF36SPH-65-A1	2 1/2"
AF36SPH-80-A1	3"
AF36SPH-100-A1	4"



PART NUMBER	TAB 'E' 316 S/S FLANGE AS2129 x PTFE HOSETAIL
AF36SPH-25-E	1"
AF36SPH-32-E	1 1/4"
AF36SPH-40-E	1 1/2"
AF36SPH-50-E	2"
AF36SPH-65-E	2 1/2"
AF36SPH-80-E	3"
AF36SPH-100-E	4"



PART NUMBER	ANSI 150 lb 316 S/S FLOATING FLANGE ASME B16.5 x PTFE HOSETAIL
AF46SPH-25-A1	1"
AF46SPH-32-A1	1 1/4"
AF46SPH-40-A1	1 1/2"
AF46SPH-50-A1	2"
AF46SPH-65-A1	2 1/2"
AF46SPH-80-A1	3"
AF46SPH-100-A1	4"



PART NUMBER	TAB 'E' 316 S/S FLOATING FLANGE AS2129 x PTFE HOSETAIL
AF46SPH-25-E	1"
AF46SPH-32-E	1 1/4"
AF46SPH-40-E	1 1/2"
AF46SPH-50-E	2"
AF46SPH-65-E	2 1/2"
AF46SPH-80-E	3"
AF46SPH-100-E	4"

**Specialised Encapsulated Fittings
Available on request.**

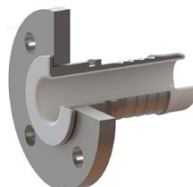

Hygienic Fittings

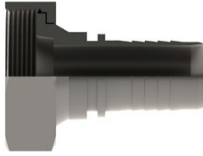

PART NUMBER	BSM 316 S/S STANDARD LINER x HEX NUT x PTFE HOSETAIL
FBSM6SPH-16	1"
FBSM6SPH-24	1 1/2"
FBSM6SPH-32	2"
FBSM6SPH-40	2 1/2"
FBSM6SPH-48	3"
FBSM6SPH-64	4"



PART NUMBER	BSM 316 S/S FLAT FACE LINER (CIP) x HEX NUT x PTFE HOSETAIL
FBSMFF6SPH-16	1"
FBSMFF6SPH-24	1 1/2"
FBSMFF6SPH-32	2"
FBSMFF6SPH-40	2 1/2"
FBSMFF6SPH-48	3"
FBSMFF6SPH-64	4"

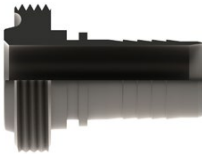

PART NUMBER	BSM 316 S/S STANDARD MALE x PTFE HOSETAIL
MBSM6SPH-16	1"
MBSM6SPH-24	1 1/2"
MBSM6SPH-32	2"
MBSM6SPH-40	2 1/2"
MBSM6SPH-48	3"
MBSM6SPH-64	4"

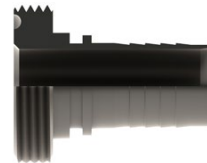

PART NUMBER	BSM 316 S/S FLAT FACE MALE (CIP) x PTFE HOSETAIL
MBSMFF6SPH-16	1"
MBSMFF6SPH-24	1 1/2"
MBSMFF6SPH-32	2"
MBSMFF6SPH-40	2 1/2"
MBSMFF6SPH-48	3"
MBSMFF6SPH-64	4"

**Specialised Encapsulated Fittings
Available on request.**

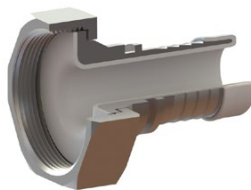

Hygienic Fittings

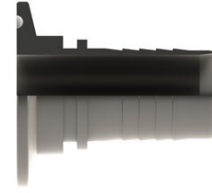

PART NUMBER	TRICLOVER 316 S/S FERRULE (STANDARD)
TRI6S-08	1/2"
TRI6S-12	3/4"
TRI6S-16	1"
TRI6S-20	1 1/4"
TRI6S-24	1 1/2"
TRI6S-32	2"
TRI6S-40	2 1/2"
TRI6S-48	3"
TRI6S-64	4"
TRI6S-96	6"

PART NUMBER	TRICLOVER 316 S/S FERRULE x HYGIENIC HOSETAIL
TRI6SFH-08	1/2"
TRI6SFH-12	3/4"
TRI6SFH-16	1"
TRI6SFH-20	1 1/4"
TRI6SFH-24	1 1/2"
TRI6SFH-32	2"
TRI6SFH-40	2 1/2"
TRI6SFH-48	3"
TRI6SFH-64	4"
TRI6SFH-96	6"

*Refer to Technical Data Section for Specifications - Page 319



PART NUMBER	TRICLOVER S/S 304 CLAMP
CLAMP4S-TRI-08	1/2"
CLAMP4S-TRI-12	3/4"
CLAMP4S-TRI-16	1"
CLAMP4S-TRI-20	1 1/4"
CLAMP4S-TRI-24	1 1/2"
CLAMP4S-TRI-32	2"
CLAMP4S-TRI-40	2 1/2"
CLAMP4S-TRI-48	3"
CLAMP4S-TRI-64	4"
CLAMP4S-TRI-96	6"

PART NUMBER	PTFE TRICLOVER SEAL
OR-T-TRI-08	1/2"
OR-T-TRI-12	3/4"
OR-T-TRI-16	1"
OR-T-TRI-20	1 1/4"
OR-T-TRI-24	1 1/2"
OR-T-TRI-32	2"
OR-T-TRI-40	2 1/2"
OR-T-TRI-48	3"
OR-T-TRI-64	4"
OR-T-TRI-96	6"

Specialised Encapsulated Fittings Available on request.

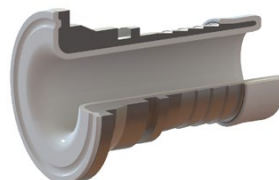

Hygienic Fittings



PART NUMBER	BSM 316 S/S STANDARD LINER
LS6S-16-BM	1"
LS6S-24-BM	1 1/2"
LS6S-32-BM	2"
LS6S-40-BM	2 1/2"
LS6S-48-BM	3"
LS6S-64-BM	4"
LS6S-96-BM	6"
LS6S-128-BM	8"



PART NUMBER	BSM 316 S/S FLAT FACE LINER (CIP)
LFF6S-16-BM	1"
LFF6S-24-BM	1 1/2"
LFF6S-32-BM	2"
LFF6S-40-BM	2 1/2"
LFF6S-48-BM	3"
LFF6S-64-BM	4"
LFF6S-96-BM	6"
LFF6S-128-BM	8"



PART NUMBER	BSM 316 S/S STANDARD MALE
MS6S-16-BM	1"
MS6S-24-BM	1 1/2"
MS6S-32-BM	2"
MS6S-40-BM	2 1/2"
MS6S-48-BM	3"
MS6S-64-BM	4"
MS6S-96-BM	6"
MS6S-128-BM	8"



PART NUMBER	BSM 316 S/S FLAT FACE MALE (CIP)
MFF6S-16-BM	1"
MFF6S-24-BM	1 1/2"
MFF6S-32-BM	2"
MFF6S-40-BM	2 1/2"
MFF6S-48-BM	3"
MFF6S-64-BM	4"
MFF6S-96-BM	6"
MFF6S-128-BM	8"

Specialised Encapsulated Fittings Available on request.

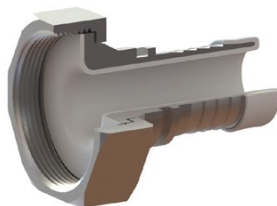

Hygienic Fittings

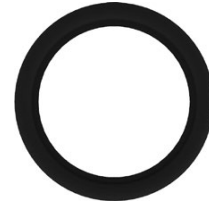

PART NUMBER	BSM 304 S/S HEX NUT
HN4S-16-BM	1"
HN4S-24-BM	1 1/2"
HN4S-32-BM	2"
HN4S-40-BM	2 1/2"
HN4S-48-BM	3"
HN4S-64-BM	4"
HN4S-96-BM	6"
HN4S-128-BM	8"

PART NUMBER	EPDM BSM 'O' RING SEAL FLAT FACE SEAL (CIP)
BSM-EPDM-FF-16	1"
BSM-EPDM-FF-24	1 1/2"
BSM-EPDM-FF-32	2"
BSM-EPDM-FF-40	2 1/2"
BSM-EPDM-FF-48	3"
BSM-EPDM-FF-64	4"
BSM-EPDM-FF-96	6"
BSM-EPDM-FF-128	8"

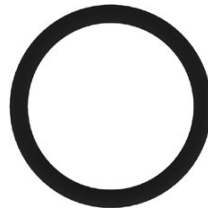

PART NUMBER	EPDM BSM 'O' RING SEAL STANDARD SEAL
BSM-EPDM-16	1"
BSM-EPDM-24	1 1/2"
BSM-EPDM-32	2"
BSM-EPDM-40	2 1/2"
BSM-EPDM-48	3"
BSM-EPDM-64	4"
BSM-EPDM-96	6"
BSM-EPDM-128	8"

Hygienic Fittings

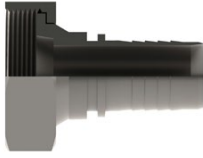

PART NUMBER	BSM 316 S/S STANDARD LINER x HEX NUT x HYGIENIC HOSETAIL
FBSM6SFH-16	1"
FBSM6SFH-24	1 1/2"
FBSM6SFH-32	2"
FBSM6SFH-40	2 1/2"
FBSM6SFH-48	3"
FBSM6SFH-64	4"
FBSM6SFH-96	6"
FBSM6SFH-128	8"



PART NUMBER	BSM 316 S/S FLAT FACE LINER (CIP) x HEX NUT x HYGIENIC HOSETAIL
FBSMFF6SFH-16	1"
FBSMFF6SFH-24	1 1/2"
FBSMFF6SFH-32	2"
FBSMFF6SFH-40	2 1/2"
FBSMFF6SFH-48	3"
FBSMFF6SFH-64	4"
FBSMFF6SFH-96	6"
FBSMFF6SFH-128	8"

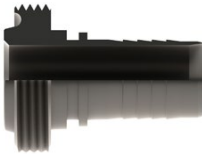

PART NUMBER	BSM 316 S/S STANDARD MALE x HYGIENIC HOSETAIL
MBSM6SFH-16	1"
MBSM6SFH-24	1 1/2"
MBSM6SFH-32	2"
MBSM6SFH-40	2 1/2"
MBSM6SFH-48	3"
MBSM6SFH-64	4"
MBSM6SFH-96	6"
MBSM6SFH-128	8"

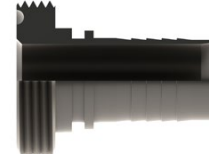

PART NUMBER	BSM 316 S/S FLAT FACE MALE (CIP) x HYGIENIC HOSETAIL
MBSMFF6SFH-16	1"
MBSMFF6SFH-24	1 1/2"
MBSMFF6SFH-32	2"
MBSMFF6SFH-40	2 1/2"
MBSMFF6SFH-48	3"
MBSMFF6SFH-64	4"
MBSMFF6SFH-96	6"
MBSMFF6SFH-128	8"

**Specialised Encapsulated Fittings
Available on request.**

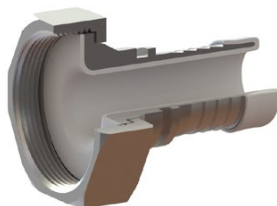

Hygienic Fittings

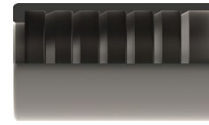

PART NUMBER	HYGIENIC 316 S/S LIFESAVER TAIL
LT6SFH-12	3/4"
LT6SFH-16	1"
LT6SFH-20	1 1/4"
LT6SFH-24	1 1/2"
LT6SFH-32	2"
LT6SFH-40	2 1/2"
LT6SFH-48	3"
LT6SFH-64	4"
LT6SFH-80	5"
LT6SFH-96	6"

PART NUMBER	HYGIENIC 316 S/S FERRULE
FF6S-08	1/2"
FF6S-10	5/8"
FF6S-12	3/4"
FF6S-16	1"
FF6S-20	1 1/4"
FF6S-24	1 1/2"
FF6S-32	2"
FF6S-40	2 1/2"
FF6S-48	3"
FF6S-64	4"
FF6S-80	5"
FF6S-96	6"

Bitumen Fittings



BITUMEN FITTINGS

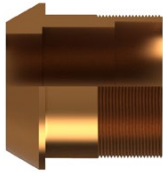

PART NUMBER	BITUMEN LOCKING CONE EXTERNAL THREAD
ALUMINIUM	
BIT-A-LCX-40	3"
BRONZE	
BIT-B-LCX-40	3"

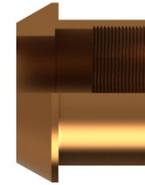

PART NUMBER	BITUMEN LOCKING CONE INTERNAL THREAD
ALUMINIUM	
BIT-A-LCI-40	2 1/2"
BRONZE	
BIT-B-LCI-40	2 1/2"



PART NUMBER	BITUMEN GLAND
ALUMINIUM	
BIT-A-G-40	2 1/2"
BRONZE	
BIT-B-G-40	2 1/2"



PART NUMBER	BITUMEN SWIVEL NUT
ALUMINIUM	
BIT-A-SN-40	2 1/2"
BRONZE	
BIT-B-SN-40	2 1/2"

Bitumen Fittings



BITUMEN FITTINGS



PART NUMBER	BITUMEN BRONZE FERRULE
BIT-B-F-40	2 1/2"



PART NUMBER	BITUMEN FIXED COUPLING
ALUMINIUM	
BIT-A-FC-40	2 1/2"
BRONZE	
BIT-B-FC-40	2 1/2"



PART NUMBER	BITUMEN DUST PLUG
ALUMINIUM	
BIT-A-DP-40	2 1/2"
BRONZE	
BIT-B-DP-40	2 1/2"



PART NUMBER	BITUMEN DUST CAP
ALUMINIUM	
BIT-A-DC-40	2 1/2"
BRONZE	
BIT-B-DC-40	2 1/2"

Pipe Flanges (AS2129)

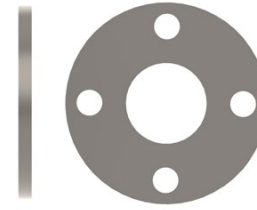
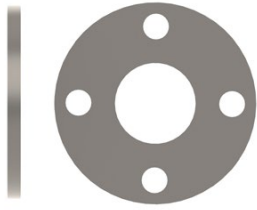

PART NUMBER	TAB 'D' 316 S/S S.O.W. PIPE FLANGE AS2129
AF36SP-12-D	1/2"
AF36SP-20-D	3/4"
AF36SP-25-D	1"
AF36SP-32-D	1 1/4"
AF36SP-40-D	1 1/2"
AF36SP-50-D	2"
AF36SP-65-D	2 1/2"
AF36SP-80-D	3"
AF36SP-100-D	4"
AF36SP-125-D	5"
AF36SP-150-D	6"
AF36SP-200-D	8"
AF36SP-250-D	10"
AF36SP-300-D	12"
AF36SP-350-D	14"
AF36SP-400-D	16"
AF36SP-450-D	18"
AF36SP-500-D	20"
AF36SP-600-D	24"

PART NUMBER	TAB 'E' 316 S/S S.O.W. PIPE FLANGE AS2129
AF36SP-12-E	1/2"
AF36SP-20-E	3/4"
AF36SP-25-E	1"
AF36SP-32-E	1 1/4"
AF36SP-40-E	1 1/2"
AF36SP-50-E	2"
AF36SP-65-E	2 1/2"
AF36SP-80-E	3"
AF36SP-100-E	4"
AF36SP-125-E	5"
AF36SP-150-E	6"
AF36SP-200-E	8"
AF36SP-250-E	10"
AF36SP-300-E	12"
AF36SP-350-E	14"
AF36SP-400-E	16"
AF36SP-450-E	18"
AF36SP-500-E	20"
AF36SP-600-E	24"

Pipe Flanges (AS2129)

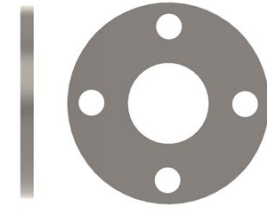
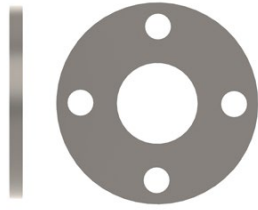

PART NUMBER	TAB 'F' 316 S/S S.O.W. PIPE FLANGE AS2129
AF36SP-12-F	1/2"
AF36SP-20-F	3/4"
AF36SP-25-F	1"
AF36SP-32-F	1 1/4"
AF36SP-40-F	1 1/2"
AF36SP-50-F	2"
AF36SP-65-F	2 1/2"
AF36SP-80-F	3"
AF36SP-100-F	4"
AF36SP-125-F	5"
AF36SP-150-F	6"
AF36SP-200-F	8"
AF36SP-250-F	10"
AF36SP-300-F	12"
AF36SP-350-F	14"
AF36SP-400-F	16"
AF36SP-450-F	18"
AF36SP-500-F	20"
AF36SP-600-F	24"

PART NUMBER	TAB 'H' 316 S/S S.O.W. PIPE FLANGE AS2129
AF36SP-12-H	1/2"
AF36SP-20-H	3/4"
AF36SP-25-H	1"
AF36SP-32-H	1 1/4"
AF36SP-40-H	1 1/2"
AF36SP-50-H	2"
AF36SP-65-H	2 1/2"
AF36SP-80-H	3"
AF36SP-100-H	4"
AF36SP-125-H	5"
AF36SP-150-H	6"
AF36SP-200-H	8"
AF36SP-250-H	10"
AF36SP-300-H	12"
AF36SP-350-H	14"
AF36SP-400-H	16"
AF36SP-450-H	18"
AF36SP-500-H	20"
AF36SP-600-H	24"

Pipe Flanges (ASME B16.5)

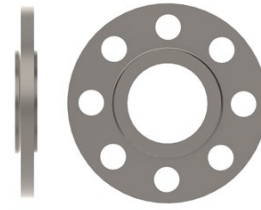
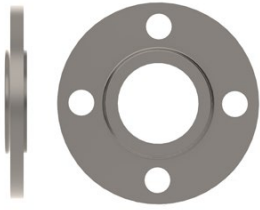

PART NUMBER	ANSI 150 lb 316 S/S S.O.W. PIPE FLANGE ASME B16.5
AF36SP-12-A1	1/2"
AF36SP-20-A1	3/4"
AF36SP-25-A1	1"
AF36SP-32-A1	1 1/4"
AF36SP-40-A1	1 1/2"
AF36SP-50-A1	2"
AF36SP-65-A1	2 1/2"
AF36SP-80-A1	3"
AF36SP-100-A1	4"
AF36SP-125-A1	5"
AF36SP-150-A1	6"
AF36SP-200-A1	8"
AF36SP-250-A1	10"
AF36SP-300-A1	12"
AF36SP-350-A1	14"
AF36SP-400-A1	16"
AF36SP-450-A1	18"
AF36SP-500-A1	20"
AF36SP-600-A1	24"

PART NUMBER	ANSI 300 lb 316 S/S S.O.W. PIPE FLANGE ASME B16.5
AF36SP-12-A3	1/2"
AF36SP-20-A3	3/4"
AF36SP-25-A3	1"
AF36SP-32-A3	1 1/4"
AF36SP-40-A3	1 1/2"
AF36SP-50-A3	2"
AF36SP-65-A3	2 1/2"
AF36SP-80-A3	3"
AF36SP-100-A3	4"
AF36SP-125-A3	5"
AF36SP-150-A3	6"
AF36SP-200-A3	8"
AF36SP-250-A3	10"
AF36SP-300-A3	12"
AF36SP-350-A3	14"
AF36SP-400-A3	16"
AF36SP-450-A3	18"
AF36SP-500-A3	20"
AF36SP-600-A3	24"

Pipe Flanges (ASME B16.5)

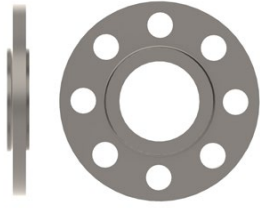

PART NUMBER	ANSI 600 lb 316 S/S S.O.W. PIPE FLANGE ASME B16.5
AF36SP-12-A6	1/2"
AF36SP-20-A6	3/4"
AF36SP-25-A6	1"
AF36SP-32-A6	1 1/4"
AF36SP-40-A6	1 1/2"
AF36SP-50-A6	2"
AF36SP-65-A6	2 1/2"
AF36SP-80-A6	3"
AF36SP-100-A6	4"
AF36SP-125-A6	5"
AF36SP-150-A6	6"
AF36SP-200-A6	8"
AF36SP-250-A6	10"
AF36SP-300-A6	12"
AF36SP-350-A6	14"
AF36SP-400-A6	16"
AF36SP-450-A6	18"
AF36SP-500-A6	20"
AF36SP-600-A6	24"

Pipe Flanges (EN 1092-1)

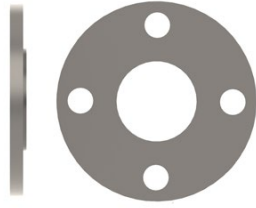

PART NUMBER	DIN 6 316 S/S S.O.W. PIPE FLANGE EN 1092-1
AF36SP-12-D6	1/2"
AF36SP-20-D6	3/4"
AF36SP-25-D6	1"
AF36SP-32-D6	1 1/4"
AF36SP-40-D6	1 1/2"
AF36SP-50-D6	2"
AF36SP-65-D6	2 1/2"
AF36SP-80-D6	3"
AF36SP-100-D6	4"
AF36SP-125-D6	5"
AF36SP-150-D6	6"
AF36SP-200-D6	8"
AF36SP-250-D6	10"
AF36SP-300-D6	12"
AF36SP-350-D6	14"
AF36SP-400-D6	16"
AF36SP-450-D6	18"
AF36SP-500-D6	20"
AF36SP-600-D6	24"

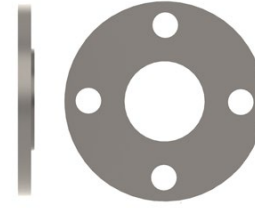

PART NUMBER	DIN 10 316 S/S S.O.W. PIPE FLANGE EN 1092-1
Use DIN 16 for sizes below 200mm	
AF36SP-250-D10	10"
AF36SP-300-D10	12"
AF36SP-350-D10	14"
AF36SP-400-D10	16"
AF36SP-450-D10	18"
AF36SP-500-D10	20"
AF36SP-600-D10	24"

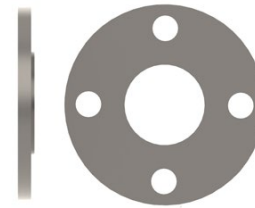

PART NUMBER	DIN 16 316 S/S S.O.W. PIPE FLANGE EN 1092-1
AF36SP-12-D16	1/2"
AF36SP-20-D16	3/4"
AF36SP-25-D16	1"
AF36SP-32-D16	1 1/4"
AF36SP-40-D16	1 1/2"
AF36SP-50-D16	2"
AF36SP-65-D16	2 1/2"
AF36SP-80-D16	3"
AF36SP-100-D16	4"
AF36SP-125-D16	5"
AF36SP-150-D16	6"
AF36SP-200-D16	8"
AF36SP-250-D16	10"
AF36SP-300-D16	12"
AF36SP-350-D16	14"
AF36SP-400-D16	16"
AF36SP-450-D16	18"
AF36SP-500-D16	20"
AF36SP-600-D16	24"

Pipe Flanges (EN 1092-1)

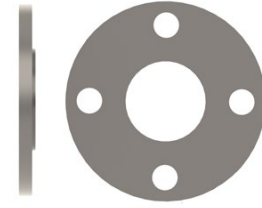
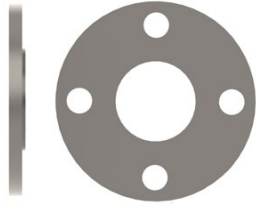

PART NUMBER	DIN 25 316 S/S S.O.W. PIPE FLANGE EN 1092-1
Use DIN 40 for sizes below 200mm	
AF36SP-250-D25	10"
AF36SP-300-D25	12"
AF36SP-350-D25	14"
AF36SP-400-D25	16"
AF36SP-450-D25	18"
AF36SP-500-D25	20"
AF36SP-600-D25	24"

PART NUMBER	DIN 40 316 S/S S.O.W. PIPE FLANGE EN 1092-1
AF36SP-12-D40	1/2"
AF36SP-20-D40	3/4"
AF36SP-25-D40	1"
AF36SP-32-D40	1 1/4"
AF36SP-40-D40	1 1/2"
AF36SP-50-D40	2"
AF36SP-65-D40	2 1/2"
AF36SP-80-D40	3"
AF36SP-100-D40	4"
AF36SP-125-D40	5"
AF36SP-150-D40	6"
AF36SP-200-D40	8"
AF36SP-250-D40	10"
AF36SP-300-D40	12"
AF36SP-350-D40	14"
AF36SP-400-D40	16"
AF36SP-450-D40	18"
AF36SP-500-D40	20"
AF36SP-600-D40	24"

Breakaway, Emergency Release and Dry Break Couplers

INTRODUCTION

Product Overview: Breakaway Couplings, Dry Break Couplings and Emergency Release Couplings

Page 258



MAINTENANCE & SERVICING

Spares Kits and Repairs

Page 259



MARINE RANGE

Size : 1/2" - 8"

Material : 316 Stainless Steel & Aluminium

Page 260



INDUSTRIAL RANGE

Size : 1/2" - 12"

Material : 316 Stainless Steel

Page 263



CRYOGENIC RANGE

Size : 1/2" to 10"

Material : 316 Stainless Steel

Page 265



Breakaway, Emergency Release and Dry Break Couplers

Product Overview:

Breakaway Couplings:

Breakaway Couplings have breakstuds that hold the two halves of the coupling together. Its purpose is to resist external loads and line pressure up to a pre-determined point. The Coupling then activates when subjected to forces higher than the breakload setting. The Breakaway Coupling range offers a safe and identifiable parting point within the transfer system and will stop flow in an emergency such as a drive-off or other strain on the transfer system.

Materials: Stainless Steel, Carbon, C276, Titanium, Alloy 20 (not all materials can be offered on the entire range)

Size: 1-1/2" - 12" (not all sizes can be offered on the entire range)

Applications: Industrial, Cryogenic and Marine

Breakload: 15KN - 160KN (Breakload varies on each range)

Breakaway Coupling Range:

Marine 2 Breakaway Couplings

Marine Breakaway Couplings

Industrial Breakaway Couplings

TTMA Breakaway Couplings

Non-cloure Breakaway Couplings



Dry Disconnect Couplings:

Connects and disconnects transfer lines with no spillage. Valves open and close automatically on connection and disconnection. This reduces the possibility of human error in transfer operations and reduces spillages to virtually zero.

Materials: Stainless Steel, Aluminium

Size: 1/2" - 8"

Applications: Liquid, Dry Gas, Cryogenic

Handle options: Round, Square Grip, Knurled Grip, Double Square (Red, Blue and polished Stainless Steel)

Standards: Fully compliant to NATO/STANAG 3756, ISO 18683, ISO 21593

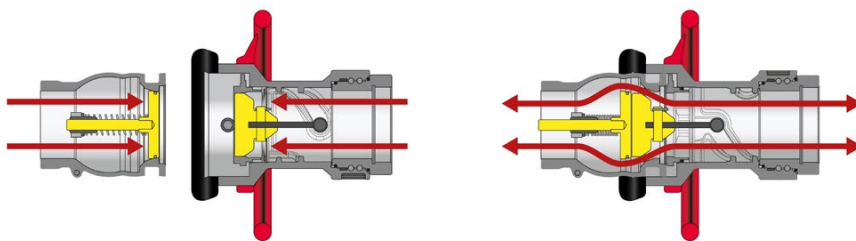

Emergency Release Couplings (ERC):

Emergency Release Couplings offer a release collar mechanism that resists operating loads via a cable or hydraulic system. A Dual release system utilising both cable and hydraulic methods is also an option. The Emergency Release System can be designed to your specific needs. In an emergency, the valves close and the ERC separates. This shuts off the downstream and upstream flows of media within the transfer system.

Materials: Stainless Steel, Aluminium, C276, Carbon Steel

Size: 1" - 10"

Applications: Industrial, Marine and Cryogenic

Breakaway Type: Cable, Hydraulic, Dual Release, Controlled Hydraulic Closure, Spring Retained, High Performance

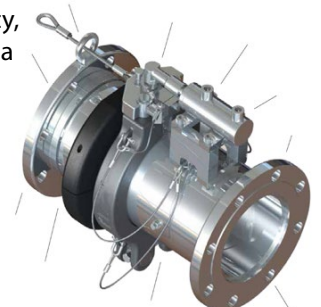

Breakaway, Emergency Release and Dry Break Couplers

Maintenance:

Installation Operations Maintenance:

To ensure that the unit performs at its optimum level, we advise that the Installation and Operational Guidelines detailed in the IOM Manual(Installation Operations Maintenance) is read and followed.

On request we can add your coupling to our Asset Management Register (HMS) to send you maintenance reminders.

Service /Spares Kit:

We recommend servicing all couplings at least annually. Service/Spares Kits can be purchased to carry out maintenance and servicing. If you require a service/spares kit all we require is the serial number marked on the coupling. This will enable us to identify the component and its settings. The below image show the typical location of Serial/Reference Numbers:



Refurbishment:

Breakaway couplings will be inspected at our facility and a quotation will then be provided detailing approximate costs and time to complete the work. As standard, the coupling will be refurbished and tested by factory trained technicians.



Breakaway, Emergency Release and Dry Break Couplers - Marine

Marine Coupling Range:

MARINE

BREAKAWAY // COUPLINGS

MARINE2 BREAKAWAY

Size : 4"

Material : Stainless Steel

Page 261



MARINE BREAKAWAY

Size : 3" - 8"

Material : Stainless Steel

Page 261

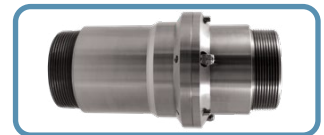

DRY DISCONNECT HOSE UNIT

Size : 1/2" to 8"

Material : Stainless Steel, Aluminium

Page 261



DRY DISCONNECT TANK UNIT

Size : 1/2" - 8"

Material : Stainless Steel, Aluminium

Page 261



KLAWZERO FULLBORE MARINE BREAKAWAY

Size : 4" - 8"

Material : Stainless Steel & Aluminium

Page 262

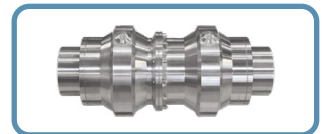

EMERGENCY RELEASE COUPLING

Size : 1" - 10"

Material : Carbon Steel, Stainless Steel

Page 262



QUICK CONNECT FLANGE

Size : 8" - 24"

Material : Forged Steel ASTM 105, Stainless Steel

Page 262



Breakaway, Emergency Release and Dry Break Couplers - Marine



MARINE2 BREAKAWAY COUPLING

Designed to limit stress and fatigue on hoses, especially when wound on hose reels. The Marine2 Breakaway Coupling is 32% shorter and 25% lighter than alternatives.

Sizes: 4"

Housing Material Options: Stainless Steel

Body and Seat Seal Options: Viton, Nitrile, EPDM, Chemraz, Kalrez

End Connections: ANSI 150/300lb, BSPP, BSPT, NPT, Hammer Fig 50/100/200 (MxF)

Break Load: 30KN to 80KN

Breakstud Materials: Stainless Steel 303, Titanium, Inconel 625

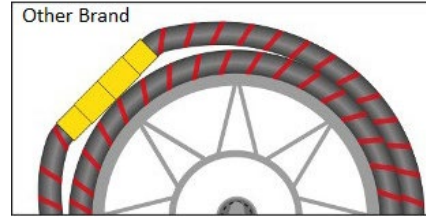
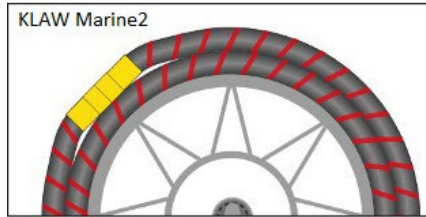

MARINE BREAKAWAY COUPLING



Marine Breakaway Coupling provides an identified and safe parting point within the hose transfer system. When tensile forces exceed predetermined tolerances, the coupling activates.

Sizes: 2 - 8"

Housing Material Options: Stainless Steel

Body and Seat Seal Options: Viton, Nitrile, EPDM, Chemraz, Kalrez, Low Temp. Nitrile

End Connections: ANSI 150/300lb, BSPP, BSPT, NPT, Hammer Fig 50/100/200 (MxF)

Break Load: 20KN to 80KN

Breakstud Materials: Stainless Steel 303, Titanium, Inconel 625



DRY DISCONNECT / DRY BREAK COUPLINGS



HOSE UNIT

The Dry Disconnect automatic valve open and closure design means there is no spillage on connection or disconnection. This prevents costly clean-up costs. These couplings are fully interchangeable with couplings that conform to STANAG 3756.

Size : 1/2" to 8"

Material : Stainless Steel, Aluminium

End Connections: ANSI 150/300lb, PN10, TTMA, PN40, BSPP, BSPT, NPT

Seal Type/Dust Seal Options: Viton, Chemraz, EPDM, GLT, Isolast, Kalrez, Low Temp Nitrile, Nitrile, NBR, Silicon, Neoprene, Cryo PTFE

Handle Options: Round, Square Grip, Knurled Grip, Double Square Grip

Handle Colour: Red, Polished ST/ST, Blue

Plug Options: Rubber, Aluminium,



TANK UNIT

The Dry Disconnect automatic valve open and closure design means there is no spillage on connection or disconnection. This prevents costly clean-up costs. These couplings are fully interchangeable with couplings that conform to STANAG 3756.

Size : 1/2" to 8"

Material : Stainless Steel, Aluminium, Super Duplex, Duplex, C276, Carbon Steel, Hastelloy

End Connections: ANSI 150/300lb, PN10, TTMA, PN40, BSPP, BSPT, NPT

Seal Type/Dust Seal Options: Viton, Chemraz, EPDM, GLT, Isolast, Kalrez, Low Temp Nitrile, Nitrile, NBR, Silicon, Neoprene, Cryo PTFE

Cap Options: Rubber, Aluminium

Breakaway, Emergency Release and Dry Break Couplers - Marine

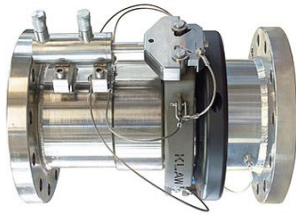

EMERGENCY RELEASE COUPLING (ERC)

Emergency Release Couplings (ERC) and Emergency Release Systems (ERS) minimise risk of spills by closing both downstream and upstream flows of media within the Hose or Loading Arm transfer system. When an event occurs, Flip-Flap Valves close and the Emergency Release Coupling separates. These couplings therefore minimise risk to assets and the environment and help protect personnel from injury. Clean-up costs and downtime are also greatly reduced.

Sizes: 1" - 10"

Pressure: 10 - 40 Bar (depending on size)

Housing Material Options: Stainless Steel, Carbon Steel

Body and Seat Seal Options: Viton, Nitrile, EPDM, Chemraz, Kalrez, Silicon, PTFE, Low Temp Nitrile, Isolast

Breakaway Type: Cable, Hydraulic, High Performance, Dual Release, Spring Retained

End Connections: ANSI 150/300lb, PN 10, 16, 25,40, BSPP, BSPT, NPT, SHD 40 Butt Weld

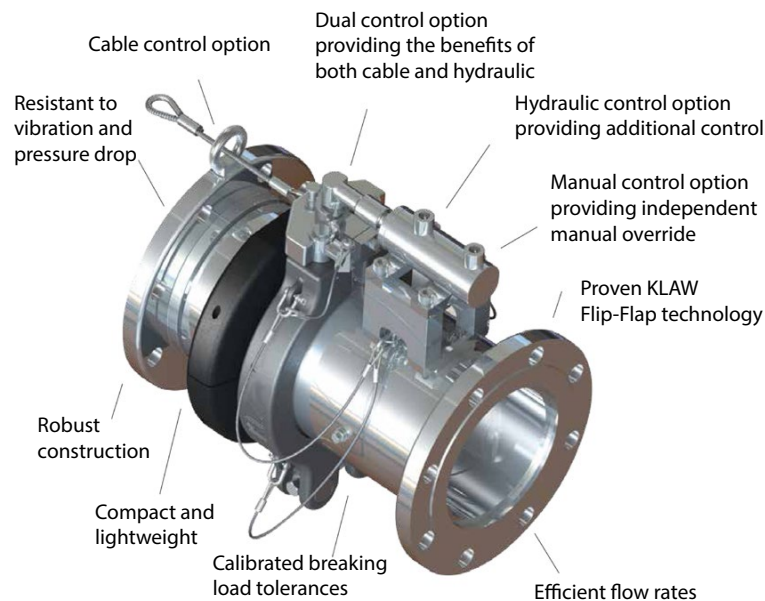

KLAZERO FULLBORE MARINE BREAKAWAY



The KLAZERO is the most efficient and robust 100% double clourse coupling in the Marine Industry. Its full bore design provides full flow with no head loss Ideal for cuttings fluid, well testing, mud and hydrocarbons in flowback operations.

Size: 4" - 8"

Housing Material Options: Stainless Steel, Aluminium

Internal Material Options: Stainless Steel, Aluminium, Titanium

Body and Seat Seal Options: Viton, Nitrile, EPDM, Chemraz, Kalrez

End Connections: ANSI 150/300lb, BSPP, BSPT, NPT

Breakstud and nut Materials: Stainless Steel 303, Titanium, Inconel 625

KLAZERO

FLANGE LOCK: QUICK CONNECT FLANGE



The quick connect Flange Lock is up to 50 times faster than traditional flange connections and is ideal for ship terminals wanting cost efficient and safe transfer solutions. No nuts, bolts or gaskets required so vessels can spend less time at berth and that means more ships off-loaded each week – delivering higher profits.

Size: 8" - 24"

Fitment Types: Short Spool Piece, Weld Neck, Studded, Slip-on

End Connections: ASME Class 150, 300, 600, DIN PN10, 16, 25, 40, JIS, etc.

FLANGE LOCK

Breakaway, Emergency Release and Dry Break Couplers - Industrial

Industrial Coupling Range:

FLOW BREAK

THE INDUSTRIAL BREAKAWAY COUPLING

INDUSTRIAL BREAKAWAY COUPLING

Page 264

Size : 1/2" - 12"

Material : Stainless Steel, Aluminium, C276, Carbon Steel, Titanium, Alloy 20



DRY DISCONNECT HOSE UNIT

Page 264

Size : 1" to 8"

Material : Stainless Steel, Aluminium



DRY DISCONNECT TANK UNIT

Page 264

Size : 1" - 8"

Material : Stainless Steel, Aluminium



EMERGENCY RELEASE COUPLING

Page 262

Size : 1" - 10"

Material : Carbon Steel, Stainless Steel

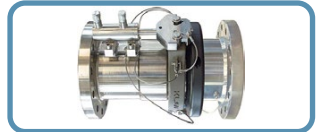

QUICK CONNECT FLANGE

Page 262

Size : 8" - 24"

Material : Forged Steel ASTM 105, Stainless Steel



Safety Breakaway Coupling are suitable for 99% of all liquids and gases.

Breakaway, Emergency Release and Dry Break Couplers - Industrial



INDUSTRIAL BREAKAWAY COUPLING

In the event of drive-off or extreme pressure surge the Flowbreak activates and delivers 100% instantaneous closure of both upstream and downstream flow. The coupling then separates therefore minimising risk of damage to assets such as loading arms, hoses, mountings and other parts of the transfer system.

Sizes: 1-1/2" - 12"

Housing Material Options: Aluminium, Stainless Steel, Carbon Steel, C276

Body and Seat Seal Options: Encapsulated PTFE, Viton, Nitrile, EPDM, Chemraz, Kalrez, Silicon, Isolast, Cryogenic PTE, White PTFE

End Connections: ANSI 150/300lb, PN10, PN25, PN40, TTMA, BSPP, BSPT, NPT, SCH40 Butt Weld

Break Load: 15KN to 160KN

Breakstud Materials: Stainless Steel 303/316, Titanium, Inconel 600/686

FLOW BREAK
THE INDUSTRIAL BREAKAWAY COUPLING

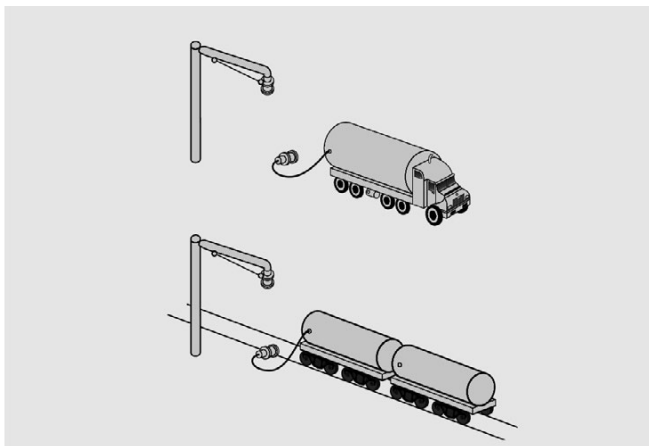

Breakaway Systems prevent spillage, damage to assets and injury to personnel.

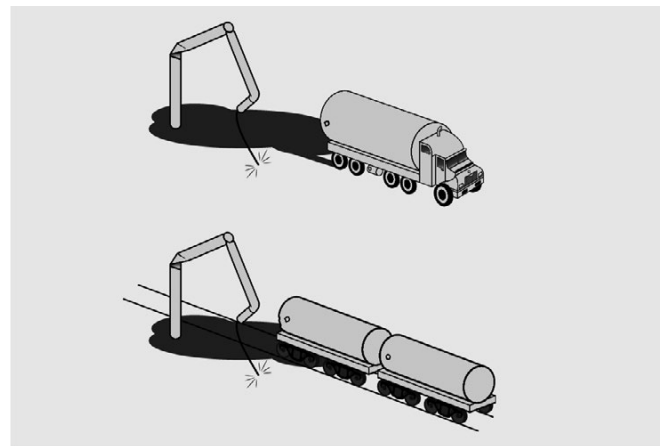

The lack of a Breakaway System in the event of a drive-off can be catastrophic.



DRY DISCONNECT / DRY BREAK COUPLINGS



HOSE UNIT

The Dry Disconnect automatic valve open and closure design means there is no spillage on connection or disconnection. This prevents costly clean-up costs. These couplings are fully interchangeable with couplings that conform to STANAG 3756.

Size : 1/2" to 8"

Material : Stainless Steel, Aluminium

End Connections: ANSI 150/300lb, PN10, TTMA, PN40, BSPP, BSPT, NPT

Seal Type/Dust Seal Options: Viton, Chemraz, EPDM, GLT, Isolast, Kalrez, Low Temp Nitrile, Nitrile, NBR, Silicon, Neoprene, Cryo PTFE

Handle Options: Round, Square Grip, Knurled Grip, Double Square Grip

Handle Colour: Red, Polished ST/ST, Blue

Plug Options: Rubber, Aluminium



TANK UNIT

The Dry Disconnect automatic valve open and closure design means there is no spillage on connection or disconnection. This prevents costly clean-up costs. These couplings are fully interchangeable with couplings that conform to STANAG 3756.

Size : 1" to 8"

Material : Stainless Steel, Aluminium, Super Duplex, Duplex, C276, Carbon Steel, Hastelloy

End Connections: ANSI 150/300lb, PN10, TTMA, PN40, BSPP, BSPT, NPT

Seal Type/Dust Seal Options: Viton, Chemraz, EPDM, GLT, Isolast, Kalrez, Low Temp Nitrile, Nitrile, NBR, Silicon, Neoprene, Cryo PTFE

Cap Options: Rubber, Aluminium

Breakaway, Emergency Release and Dry Break Couplers - Cryogenic

Cryogenic Coupling Range:

CRYO BREAK

THE CRYOGENIC BREAKAWAY COUPLING

CRYOGENIC BREAKAWAY

Size : 1/2" - 4"

Material : Stainless Steel

Page 266



CRYOGENIC DRY DISCONNECT HOSE UNIT

Size : 1" - 8"

Material : Stainless Steel

Page 266



CRYOGENIC DRY DISCONNECT TANK UNIT

Size : 1" - 8"

Material : Stainless Steel

Page 266



CRYOGENIC EMERGENCY RELEASE COUPLING

Size : 1" - 10"

Material : Stainless Steel

Page 267

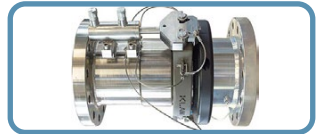

QUICK CONNECT FLANGE

Size : 8" - 24"

Material : Forged Steel ASTM 105, Stainless Steel

Page 262



Breakaway, Emergency Release and Dry Break Couplers - Cryogenic



CRYOGENIC BREAKAWAY COUPLING

The Cryobreak Breakaway Coupling minimises the risk of cryogenic media spills; this reduces the risk of both damage to assets and injury to personnel in the event of a drive-off or extreme pressure flow. It has been designed and manufactured for the safe transfer of media at cryogenic temperatures.

Sizes: 1/2" - 4"

Temperature: -196°C to +70°C

CRYO BREAK
THE CRYOGENIC BREAKAWAY COUPLING

Housing Material Options: Stainless Steel

Sealing Options: Cryo, Viton, Nitrile, EPDM, Low Temp Nitrile, Chemraz, Kalrez, PTFE Isolast, GLT Viton

End Connections: ANSI 150/300lb, PN10, PN25, PN40, TTMA, BSPP, BSPT, NPT, SCH40 Butt Weld

Break Load: 15KN to 60KN

Breakstud Materials: Stainless Steel 316

CRYODC
HOSE AND TANK COUPLINGS

CRYOGENIC DRY DISCONNECT / DRY BREAK COUPLINGS



HOSE UNIT

The CryoDC is simple to use, fast to connect and disconnect, reliable and much safer than traditional flange connections or CGA fittings. Designed and interchangeable to ISO 18683

Size : 1" to 8"

Material : Stainless Steel

End Connections: ANSI 150, NPT Female (other connections available)

Seal: PTFE

Applications: LNG, Cryogenic gas, Bunkering, Tank Storage, Refuelling, Air Separation, Railcards and Trucks, ISO Tanks.



TANK UNIT

The CryoDC is simple to use, fast to connect and disconnect, reliable and much safer than traditional flange connections or CGA fittings. Designed and interchangeable to ISO 18683

Size : 1" to 8"

Material : Stainless Steel

End Connections: ANSI 150, NPT Female (other connections available)

Seal: PTFE

Cap Options: Aluminium (pictured below)



Breakaway, Emergency Release and Dry Break Couplers - Cryogenic

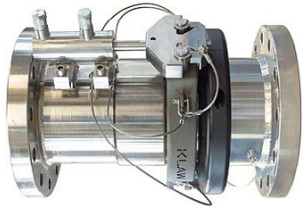

CRYOGENIC EMERGENCY RELEASE COUPLING

Emergency Release Couplings (ERC) minimise risk of spills by closing both downstream and upstream flows of media within the Hose or Loading Arm transfer system. With utilisation of a collar release mechanism rather than the regular breakstud release options the collar release offers a set predetermined activation point before there is any over extension of the attached loading system or hose assembly. The Cryogenic ERC ensuring 100% closure: even in the most demanding of operating conditions.

Temperature: -196°C to +70°C

Housing Material Options: Stainless Steel, Carbon Steel

Seal: Cryogenic PTFE

End Connections: ANSI 150/, NPT Female (other connections available)



LNG Emergency Release Systems





07



SWIVEL JOINTS

The Range

STRAIGHT SWIVEL JOINT

Size : 1/2" to 8"

Working Pressure : 250 psi

Style: 20

Page 270



90° SWIVEL JOINT

Size : 1/2" to 8"

Working Pressure : 250 psi

Style: 30

Page 271



FLANGED SWIVEL JOINT

Size : 1/2" to 8"

Working Pressure : 250 psi

Style: 20

Page 272



180° SWIVEL JOINT

Size : 1/2" to 8"

Working Pressure : 250 psi

Style: 80

Page 273



Swivel Joint - Straight

Straight Swivel Joint (Style 20)

Bearing type: Stainless Steel
Bush Type: PTFE / Brass / Ertalon LFX Nylon
Life Span: 5 years
 (Depends on installation, operating conditions and maintenance)
Pipe loading: Capable up to 150Kg (Higher on Request)
Size Available: 1/2" - 8" (Larger on Request)
Max Temp: - 50°C - 300°C (Dependant on bushing material Type)

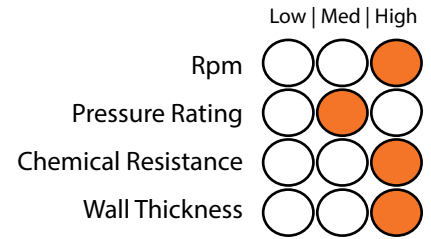

Revolutions per minute (Rpm):

Low hand driven Rpm

(Bush type – Fluoropolymer)

High Machine Rpm

(Bush type - Needle roller / bearings)



Maintenance and schedule installation guide provided. Page 274

Part Number	Imperial Size	Standard Pressure (psi)	
		psi	kPa
SJ#-0808-SS-*X_X_	1/2"	250	1723
SJ#-1212-SS-*X_X_	3/4"	250	1723
SJ#-1616-SS-*X_X_	1"	250	1723
SJ#-2020-SS-*X_X_	1 1/4"	250	1723
SJ#-2424-SS-*X_X_	1 1/2"	250	1723
SJ#-3232-SS-*X_X_	2"	250	1723
SJ#-4040-SS-*X_X_	2 1/2"	250	1723
SJ#-4848-SS-*X_X_	3"	250	1723
SJ#-6464-SS-*X_X_	4"	250	1723
SJ#-8080-SS-*X_X_	5"	250	1723
SJ#-9696-SS-*X_X_	6"	250	1723
SJ#-128128-SS-*X_X_	8"	250	1723

Higher Pressure on Request

All Swivel Joints are tested to a standard 500 psi. (Higher test pressure if required)

Table Key

Material Type

6S = 316 S/S, PT = PTFE, PP = Polypropylene
 MS = Mild Steel

Connection Type X

F = Female, M = Male, FL = Flange

Seals Type *

V = Viton, E = EPDM, P = PTFE, N = Neoprene,
 B = Buna Nitrile

Thread & Flange Type _

BP = BSPP, BT = BSPT, NT = NPT, JC = JIC, M = Metric, BW = Butt weld,
 SW = Socket-weld, A = ANSI (State Class), TE = Table 'E',
 TD = Table 'D', TF = Table 'F', TH = Table 'H', D = DIN 16, C = Custom

Applications



Swivel Joint - 90° Deg

90° Deg Swivel Joint (Style 30)

Bearing type: Stainless Steel
Bush Type: PTFE / Brass / Ertalon LFX Nylon
Life Span: 5 years
 (Depends on installation, operating conditions and maintenance)
Pipe loading: Capable up to 150Kg (Higher on Request)
Size Available: 1/2" - 8" (Larger on Request)
Max Temp: - 50°C - 300°C (Dependant on bush material type)

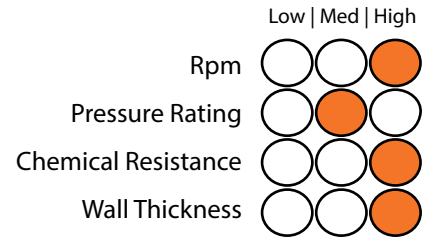

Revolutions per minute (Rpm):

Low hand driven Rpm
 (Bush type – Fluoropolymer)
High Machine Rpm
 (Bush type - Needle roller / bearings)



Maintenance and schedule installation guide provided. Page 274

Part Number	Imperial Size	Standard Pressure (psi)	
		psi	kPa
SJ#-0808-90-*X_X_	1/2"	250	1723
SJ#-1212-90-*X_X_	3/4"	250	1723
SJ#-1616-90-*X_X_	1"	250	1723
SJ#-2020-90-*X_X_	1 1/4"	250	1723
SJ#-2424-90-*X_X_	1 1/2"	250	1723
SJ#-3232-90-*X_X_	2"	250	1723
SJ#-4040-90-*X_X_	2 1/2"	250	1723
SJ#-4848-90-*X_X_	3"	250	1723
SJ#-6464-90-*X_X_	4"	250	1723
SJ#-8080-90-*X_X_	5"	250	1723
SJ#-9696-90-*X_X_	6"	250	1723
SJ#-128128-90-*X_X_	8"	250	1723

Higher Pressure on Request
 All Swivel Joints are tested to a standard 500 psi. (Higher test pressure if required)

Table Key

Material Type #
 6S = 316 S/S, PT = PTFE, PP = Polypropylene
 MS = Mild Steel

Connection Type X
 F = Female, M = Male, FL = Flange

Seals Type *
 V = Viton, E = EPDM, P = PTFE, N = Neoprene,
 B = Buna Nitrile

Thread & Flange Type _
 BP = BSPP, BT = BSPT, NT = NPT, JC = JIC, M = Metric, BW = Butt weld,
 SW = Socket-weld, A = ANSI (State Class), TE = Table 'E',
 TD = Table 'D', TF = Table 'F', TH = Table 'H', D = DIN 16, C = Custom

Applications



Swivel Joint - Flanged

Flanged Swivel Joint (Style 20)

Bearing type: Stainless Steel
Bush Type: PTFE / Brass / Ertalon LFX Nylon
Life Span: 5 years
 (Depends on installation, operating conditions and maintenance)
Pipe loading: Capable up to 150Kg (Higher on Request)
Size Available: 1/2" - 8" (Larger on Request)
Max Temp: - 50°C - 300°C (Dependant on bush material type)

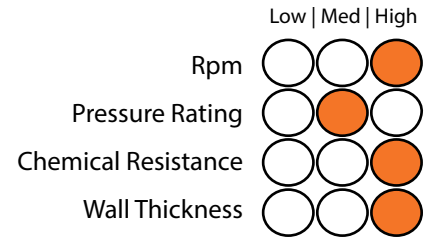

Revolutions per minute (Rpm):

Low hand driven Rpm
 (Bush type – Fluoropolymer)
High Machine Rpm
 (Bush type - Needle roller / bearings)

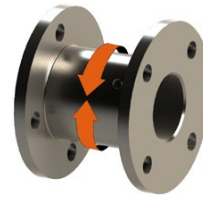

Maintenance and schedule installation guide provided. Page 274

Part Number	Imperial Size	Standard Pressure (psi)	
		psi	kPa
SJ#-0808-FF-*X_X_	1/2"	250	1723
SJ#-1212-FF-*X_X_	3/4"	250	1723
SJ#-1616-FF-*X_X_	1"	250	1723
SJ#-2020-FF-*X_X_	1 1/4"	250	1723
SJ#-2424-FF-*X_X_	1 1/2"	250	1723
SJ#-3232-FF-*X_X_	2"	250	1723
SJ#-4040-FF-*X_X_	2 1/2"	250	1723
SJ#-4848-FF-*X_X_	3"	250	1723
SJ#-6464-FF-*X_X_	4"	250	1723
SJ#-8080-FF-*X_X_	5"	250	1723
SJ#-9696-FF-*X_X_	6"	250	1723
SJ#-128128-FF-*X_X_	8"	250	1723

Higher Pressure on Request
 All Swivel Joints are tested to a standard 500 psi. (Higher test pressure if required)

Table Key

Material Type #
 6S = 316 S/S, PT = PTFE, PP = Polypropylene
 MS = Mild Steel

Connection Type X
 F = Female, M = Male, FL = Flange

Seals Type *
 V = Viton, E = EPDM, P = PTFE, N = Neoprene,
 B = Buna Nitrile

Thread & Flange Type _
 BP = BSPP, BT = BSPT, NT = NPT, JC = JIC, M = Metric, BW = Butt weld,
 SW = Socket-weld, A = ANSI (State Class), TE = Table 'E',
 TD = Table 'D', TF = Table 'F', TH = Table 'H', D = DIN 16, C = Custom

Applications



Swivel Joint - 180° Deg

180° Deg Swivel Joint (Style 80)

Bearing type: Stainless Steel
Bush Type: PTFE / Brass / Ertalon LFX Nylon
Life Span: 5 years
 (Depends on installation, operating conditions and maintenance)
Pipe loading: Capable up to 150Kg (Higher on Request)
Size Available: 1/2" - 8" (Larger on Request)
Max Temp: - 50°C - 300°C (Dependant on bush material type)

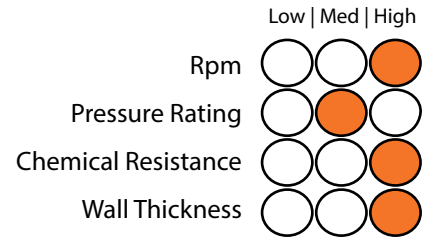

Revolutions per minute (Rpm):

Low hand driven Rpm

(Bush type – Fluoropolymer)

High Machine Rpm

(Bush type - Needle roller / bearings)



Maintenance and schedule installation guide provided. Page 274

Part Number	Imperial Size	Dash	Standard Pressure (psi)	
			psi	kPa
SJ#-0808-ZZ-*X_X_	1/2"	08	250	1723
SJ#-1212-ZZ-*X_X_	3/4"	12	250	1723
SJ#-1616-ZZ-*X_X_	1"	16	250	1723
SJ#-2020-ZZ-*X_X_	1 1/4"	20	250	1723
SJ#-2424-ZZ-*X_X_	1 1/2"	24	250	1723
SJ#-3232-ZZ-*X_X_	2"	32	250	1723
SJ#-4040-ZZ-*X_X_	2 1/2"	40	250	1723
SJ#-4848-ZZ-*X_X_	3"	48	250	1723
SJ#-6464-ZZ-*X_X_	4"	64	250	1723
SJ#-8080-ZZ-*X_X_	5"	80	250	1723
SJ#-9696-ZZ-*X_X_	6"	96	250	1723
SJ#-128128-ZZ-*X_X_	8"	128	250	1723

Higher Pressure on Request

All Swivel Joints are tested to a standard 500 psi. (Higher test pressure if required)

Table Key

Material Type #

6S = 316 S/S, PT = PTFE, PP = Polypropylene
 MS = Mild Steel

Connection Type X

F = Female, M = Male, FL = Flange

Seals Type *

V = Viton, E = EPDM, P = PTFE, N = Neoprene,
 B = Buna Nitrite

Thread & Flange Type _

BP = BSPP, BT = BSPT, NT = NPT, JC = JIC, M = Metric, BW = Butt weld,
 SW = Socket-weld, A = ANSI (State Class), TE = Table 'E',
 TD = Table 'D', TF = Table 'F', TH = Table 'H', D = DIN 16, C = Custom

Applications



Installation Guide

Swivel Joint Installation Guide

Standard practices should be used when installing Swivel Joints in a system.

1. Before installing the swivel joint the personal protective equipment must be applied. (AS/NZS 1337.6 Certified safety glasses)
2. Check that the orientation is allowing for the required degree of movement for the relative motion
3. Check that the end connections are the same size
4. Check operating pressure on the system are sustainable by the swivel joint
5. Fully seal swivel joint connection before applying any pressure
6. When swivel joint is installed do not strike, tighten or loosen



Preventive Maintenance

The Swivel Joint is constructed with superior sealing and corrosion protection. Little preventive maintenance is therefore required, but should include the following:

Working fluids, especially acids, should be thoroughly flushed from the swivel after each use to avoid pitting and corrosion.

If any leaks are detected the swivel should be removed immediately and reported to Pacific Hoseflex. This is to prevent potential personal injury and/or damage.

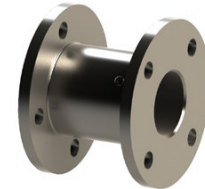

Periodic Inspection

Periodic inspection shall be undertaken to verify the condition of the swivel joint assembly. The frequency of inspection should be matched to the frequency of use and severity of the application. The periodic inspection should include: Visual inspection of end connections, looking for general corrosion, end connection thread wear and/or corrosion, and any damage or deformations.

Determine if any leakage has occurred and if so, shut down system and investigate leak cause. If leaking from end threads or flange try resealing the swivel joint. If leaking from the swivel joint joining section report to Pacific Hoseflex.



Movements

The swivel joint can absorb relative motion only if the styles and orientation of the swivels allow sufficient degrees of freedom. The swivels must be oriented to provide the required movements in each plane of motion and axis of rotation. When connecting swivels between fixed end connections, regardless of subsequent relative motion, enough freedom must exist to properly make the connection without loading or binding the swivel.

Alignment

Pipe alignment is crucial to the operation of the swivel joint. If Swivel joint is not installed in correct alignment this will have major affects on of the working conditions. Consult Pacific Hoseflex for additional information on recommended line layout. Pipe work that is offset can be compensated with a flexible connector for Pacific Hoseflex.



Loadings

Externally applied loads can result in an over-stress condition and catastrophic failure. If externally applied loads are to be applied, consult Pacific Hoseflex for limitations.

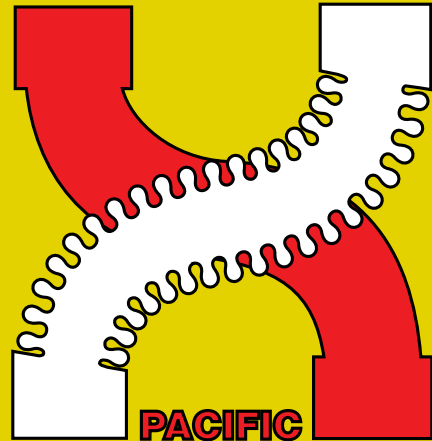

PACIFIC

HOSEFLEX

PTY LTD

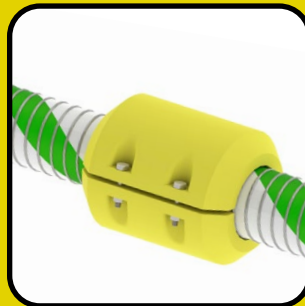

08



COVERS

Range

Silicone Coated Fibreglass Sleeve

Size : 6mm to 130mm

Material : Silicone



Wire Spring Guard

Size : 20mm to 100mm

Material : 316/304 Stainless Steel, Galvanised



Wire Bend Restrictor

Size : 20mm to 100mm

Material : 316/304 Stainless Steel, Galvanised



Pigstail

Size : 7mm to 99mm I.D.

Material : HPDE (High Density Polyethylene)



Whipsock

Size : 14mm to 180mm

Material : 316/304 Stainless Steel, Galvanised



Stainless Steel Interlock Cover

Size : 3/4" - 12"

Material : 304 Stainless Steel



Layflat

Size : 20mm to 200mm I.D.

Material : PVC with low pressure stability



PVC Covering

Size : 1.6mm to 125.0mm

Material : Polyolefin



Rope Lag

Size : 6mm to 48mm

Material : Sisal Rope



Hose Floats

Size : 10mm - 130mm Hose O.D.

Material : Polyethyle



Bird & Rodent Proofing Briad

Size : 6mm to 150mm

Material : 316/304 Stainless Steel



Rawhide

Size : 22.9mm to 93.0mm

Material : Nylon



Ball Joint Armor

Size : 1" - 6"

Material : Stainless Steel, Galvanised



Hose Handling Sling/Bun

Size : 25mm - 200mm Hose Dia.

Material : 100% nylon webbing / Polyurethane



Hose Handling - Trolleys

Size : 280mm, 856mm and custom

Material : Structural Grade Steel AS/NZS 1163 C250



Please visit hoseflex.com for specifications and part numbers.



PACIFIC
HOSEFLEX
PTY LTD

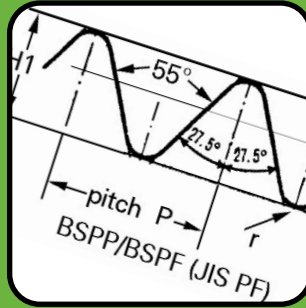

09

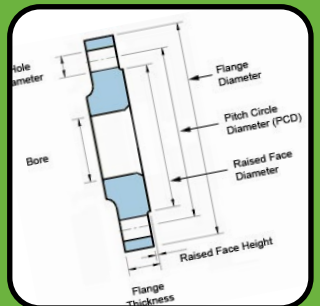
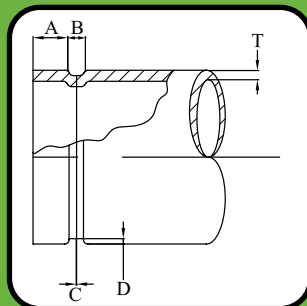
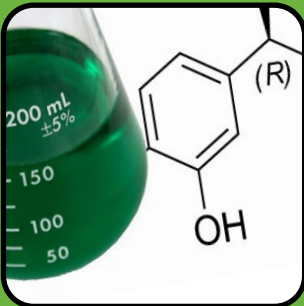

TECHNICAL DATA

10.01 | Flange Specification (AS 2129)

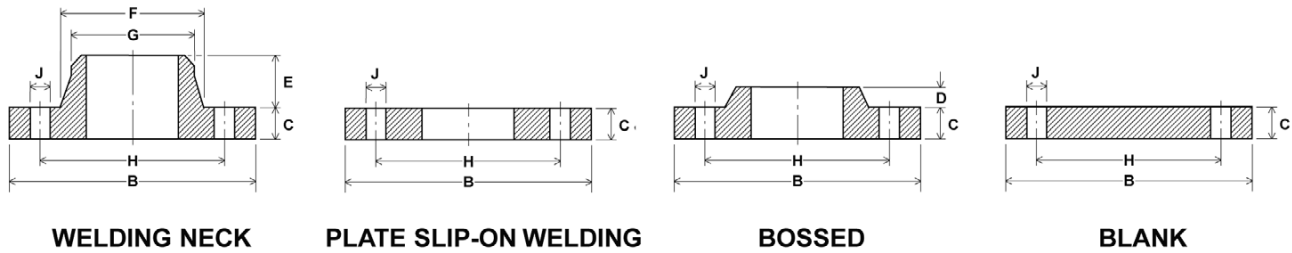

TABLE D

Nominal Pipe Size	Outside Diameter of Pipe	Flange Outside Diameter	Thickness of Flange		Length Through Hub		Diameter at Large End of Neck	Diameter at Small End of Neck	Drilling Data			
			Copper Alloy	Plate or Forged	Length of Boss	Length of Welding Neck			Bolt Circle Diameter	Diameter of Bolt Holes	Number of Bolts	
mm	inch	A	B	C	C	D	E	F	G	H	J	K
15	1/2"	21.3	95	6	5	10	22	27	22	67	14	4
20	3/4"	26.7	100	6	5	11	22	33	27	73	14	4
25	1"	33.4	115	8	5	11	22	43	34	83	14	4
32	1 1/4"	42.2	120	8	6	11	26	49	43	87	14	4
40	1 1/2"	48.3	135	10	6	13	29	59	49	98	14	4
50	2"	60.3	150	10	8	13	29	70	61	114	19	4
65	2 1/2"	73	165	11	8	16	32	83	76	127	19	4
80	3"	88.9	185	13	10	16	35	102	89	146	19	4
100	4"	114.3	215	16	10	19	41	130	115	178	19	4
125	5"	141.3	255	17	13	19	44	152	142	210	19	8
150	6"	168.3	280	17	13	19	48	187	169	235	19	8
200	8"	219.1	335	19	13	22	51	241	220	292	19	8
250	10"	273.8	405	19	16	27	64	292	274	356	22	8
300	12"	323.8	455	22	19	29	70	343	324	406	22	12
350	14"	355.6	525	25	22	-	73	387	356	470	26	12
400	16"	406.4	580	25	22	-	-	-	-	521	26	12
450	18"	457	640	29	25	-	-	-	-	584	26	12
500	20"	508	705	32	29	-	-	-	-	641	26	16
600	24"	610	825	35	32	-	-	-	-	756	30	16

Note:

- Dimensions are in (mm)
- Larger sizes available on request
- Thickness dimension include raised face
- Available with or without raised face
- Pipe diameter to ANSI standard
- Bore to suit customers pipe

10.02 | Flange Specification (AS 2129)

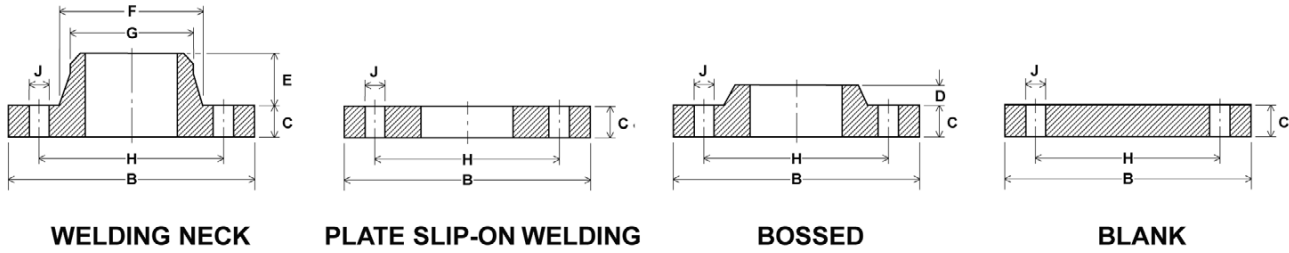

TABLE E

Nominal Pipe Size	Outside Diameter of Pipe	Flange Outside Diameter	Thickness of Flange		Length Through Hub		Drilling Data					
			Copper Alloy	Plate or Forged	Length of Boss	Length of Welding Neck	Diameter at Large End of Neck	Diameter at Small End of Neck	Bolt Circle Diameter	Diameter of Bolt Holes	Number of Bolts	
mm	inch	A	B	C	C	D	E	F	G	H	J	K
15	1/2"	21.3	95	6	6	10	22	27	22	67	14	4
20	3/4"	26.7	100	6	6	11	22	33	27	73	14	4
25	1"	33.4	115	8	7	11	22	43	34	83	14	4
32	1 1/4"	42.2	120	8	8	11	26	49	43	87	14	4
40	1 1/2"	48.3	135	10	9	13	29	59	49	98	14	4
50	2"	60.3	150	10	10	13	29	70	61	114	18	4
65	2 1/2"	73	165	11	10	16	32	83	76	127	18	4
80	3"	88.9	185	13	11	16	35	102	89	146	18	4
100	4"	114.3	215	16	13	19	41	130	115	178	18	8
125	5"	141.3	255	17	14	19	44	152	142	210	18	8
150	6"	168.3	280	17	17	19	48	184	169	235	22	8
200	8"	219.1	335	19	19	22	51	241	220	292	22	8
250	10"	273.8	405	25	22	27	64	292	274	356	22	12
300	12"	323.8	455	28	25	29	70	343	324	406	26	12
350	14"	355.6	525	32	29	-	73	387	356	470	26	12
400	16"	406.4	580	32	32	-	-	-	-	521	26	12
450	18"	457	640	35	35	-	-	-	-	584	26	16
500	20"	508	705	38	38	-	-	-	-	641	26	16
600	24"	610	825	48	48	-	-	-	-	756	33	16

Note:

- Dimensions are in (mm)
- Larger sizes available on request
- Thickness dimension include raised face
- Available with or without raised face
- Pipe diameter to ANSI standard
- Bore to suit customers pipe

10.03 | Flange Specification (AS 2129)

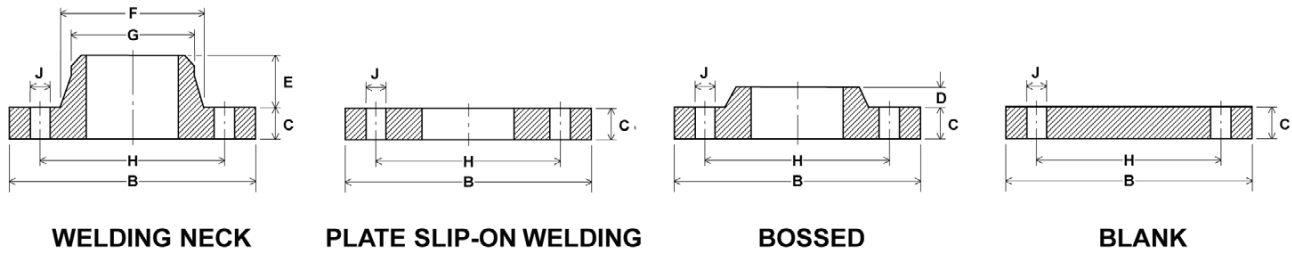

TABLE F

Nominal Pipe Size		Outside Diameter of Pipe	Flange Outside Diameter	Thickness of Flange		Length Through Hub		Diameter at Large End of Neck		Diameter at Small End of Neck		Drilling Data		
				Copper Alloy	Plate or Forged	Length of Boss	Length of Welding Neck					Bolt Circle Diameter	Diameter of Bolt Holes	Number of Bolts
mm	inch	A	B	C	C	D	E	F	G	H	J	K		
15	1/2"	21.3	95	8	10	10	22	27	22	67	14	4		
20	3/4"	26.7	100	8	10	11	22	33	27	73	14	4		
25	1"	33.4	120	10	10	11	29	43	34	87	18	4		
32	1 1/4"	42.2	135	10	13	11	35	52	43	98	18	4		
40	1 1/2"	48.3	140	11	13	13	35	59	49	105	18	4		
50	2"	60.3	165	11	16	13	35	70	61	127	18	4		
65	2 1/2"	73	185	13	16	16	38	86	76	146	18	8		
80	3"	88.9	205	14	16	16	44	102	89	165	18	8		
100	4"	114.3	230	17	19	19	51	130	115	191	18	8		
125	5"	141.3	280	19	22	19	57	159	142	235	22	8		
150	6"	168.3	305	22	22	19	57	184	169	260	22	12		
200	8"	219.1	370	25	25	22	67	241	220	324	22	12		
250	10"	273.8	430	25	29	27	73	298	274	381	26	12		
300	12"	323.8	490	29	32	29	79	352	324	438	26	16		
350	14"	355.6	550	32	35	-	86	387	356	495	30	16		
400	16"	406.4	610	32	41	-	-	-	-	552	30	20		
450	18"	457	675	35	44	-	-	-	-	610	33	20		
500	20"	508	735	38	51	-	-	-	-	673	33	24		
600	24"	610	850	41	57	-	-	-	-	781	36	24		

Note:

- Dimensions are in (mm)
- Larger sizes available on request
- Thickness dimension include raised face
- Available with or without raised face
- Pipe diameter to ANSI standard
- Bore to suit customers pipe

10.04 | Flange Specification (AS 2129)

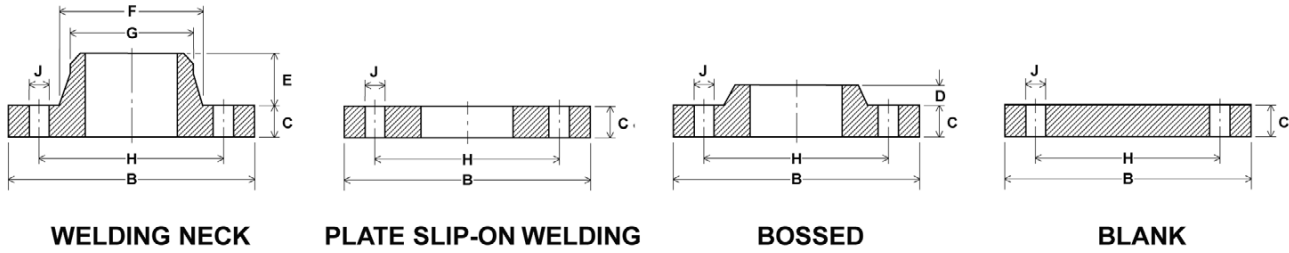

TABLE H

Nominal Pipe Size	Outside Diameter of Pipe	Flange Outside Diameter	Thickness of Flange		Length Through Hub		Drilling Data					
			Copper Alloy	Plate or Forged	Length of Boss	Length of Welding Neck	Diameter at Large End of Neck	Diameter at Small End of Neck	Bolt Circle Diameter	Diameter of Bolt Holes	Number of Bolts	
mm	inch	A	B	C	C	D	E	F	G	H	J	K
15	1/2"	21.3	115	10	13	10	29	30	22	83	18	4
20	3/4"	26.7	115	10	13	11	29	35	27	83	18	4
25	1"	33.4	120	11	14	11	29	43	34	87	18	4
32	1 1/4"	42.2	135	11	17	11	35	52	43	98	18	4
40	1 1/2"	48.3	140	13	17	13	35	59	49	105	18	4
50	2"	60.3	165	13	19	13	35	70	61	127	18	4
65	2 1/2"	73	185	14	19	16	38	86	76	146	18	8
80	3"	88.9	205	16	22	16	44	102	89	165	18	8
100	4"	114.3	230	19	25	19	51	130	115	191	18	8
125	5"	141.3	280	22	29	19	57	159	142	235	22	8
150	6"	168.3	305	25	29	19	57	184	169	260	22	12
200	8"	219.1	370	32	32	22	67	241	220	324	22	12
250	10"	273.8	430	35	35	27	73	298	274	381	26	12
300	12"	323.8	490	38	41	29	79	352	324	438	26	16
350	14"	355.6	550	41	48	-	86	387	356	495	30	16
400	16"	406.4	610	44	54	-	-	-	-	552	30	20
450	18"	457	675	48	60	-	-	-	-	610	33	20
500	20"	508	735	51	67	-	-	-	-	673	33	24
600	24"	610	850	57	76	-	-	-	-	781	36	24

Note:

- Dimensions are in (mm)
- Larger sizes available on request
- Thickness dimension include raised face
- Available with or without raised face
- Pipe diameter to ANSI standard
- Bore to suit customers pipe

10.05 | Flange Specification (ASME B16.5)

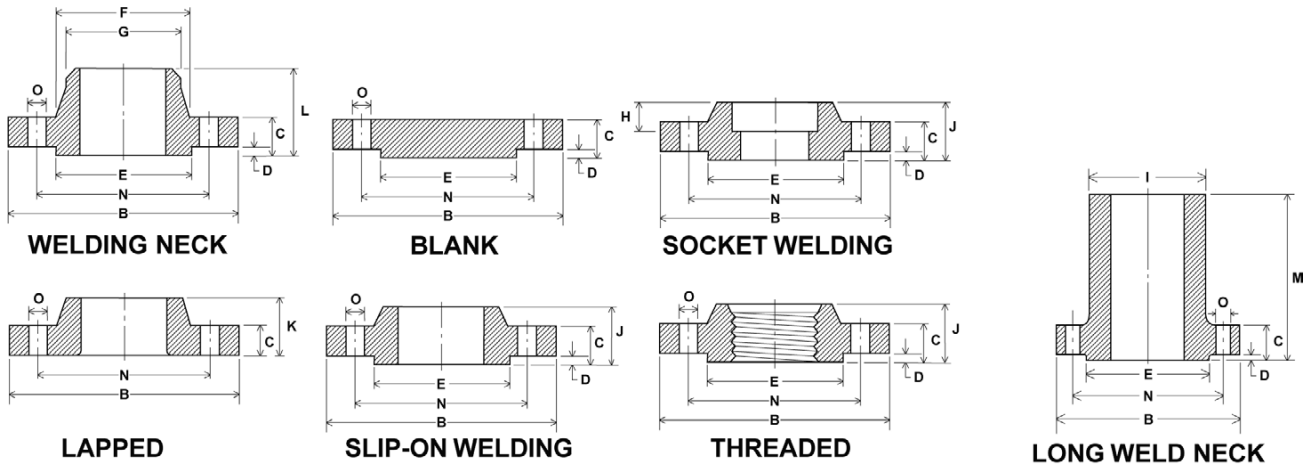

CLASS 150

Nominal Pipe Size		Outside Diameter of Pipe	Flange Outside Diameter	Thickness of Flange Min	Rasied Face Thickness	Rasied Face Diameter	Hub Diameter	Hub Dia. Start of Chamfer W. Neck	Socket Weld Depth	Hub Dia. Long Weld Neck	Length Through Hub			Drilling Data			
											Thread Slip on Socket Welding	Lapped	Welding Neck	Long Welding Neck	Bolt Circle Diameter	Diameter of Bolt Holes	Number of Bolts
mm	inch	A	B	C	D	E	F	G	H	I	J	K	L	M	N	O	P
15	1/2"	21.3	90	11.5	1.6	34.9	30	21.5	9.5	30.2	16	16	48	228.6	60.5	16	4
20	3/4"	26.7	98	13.0	1.6	42.9	38	26.5	11.1	38.1	16	16	52	228.6	70.0	16	4
25	1"	33.4	108	14.5	1.6	50.8	49	33.5	12.7	50.8	17	17	56	228.6	79.5	16	4
32	1 1/4"	42.2	117	16.0	1.6	63.5	59	42.0	14.2	60.3	21	21	57	228.6	89.0	16	4
40	1 1/2"	48.3	127	17.5	1.6	73.0	65	48.5	15.7	66.7	22	22	62	228.6	98.5	16	4
50	2"	60.3	152	19.5	1.6	92.1	78	60.5	17.5	82.5	25	25	64	228.6	120.5	20	4
65	2 1/2"	73	178	22.5	1.6	104.8	90	73.0	19.1	95.2	29	29	70	228.6	139.5	20	4
80	3"	88.9	191	24.0	1.6	127.0	108	89.0	20.6	107.9	30	30	70	304.8	152.5	20	4
100	4"	114.3	229	24.0	1.6	157.0	135	114.5	-	139.7	32	33	76	304.8	190.5	20	8
125	5"	141.3	254	24.0	1.6	185.7	164	141.5	-	165.1	36	36	89	304.8	216.0	23	8
150	6"	168.3	279	25.5	1.6	215.9	192	168.5	-	196.8	40	40	89	304.8	241.5	23	8
200	8"	219.1	343	29.0	1.6	269.9	246	219.0	-	247.6	44	44	102	304.8	298.5	23	8
250	10"	273.8	406	30.5	1.6	323.8	305	273.0	-	304.8	49	49	102	304.8	362.0	26	12
300	12"	323.8	483	32.0	1.6	381.0	365	324.0	-	365.1	56	56	114	304.8	432.0	26	12
350	14"	355.6	535	35.0	1.6	412.8	400	355.5	-	406.4	57	79	127	304.8	476.5	29	12
400	16"	406.4	600	37.0	1.6	469.9	457	406.5	-	457.2	64	87	127	304.8	540.0	29	16
450	18"	457	635	40.0	1.6	533.4	505	457.0	-	508.0	68	97	140	304.8	578.0	32	16
500	20"	508	700	43.0	1.6	584.2	559	508.0	-	558.8	73	103	145	304.8	635.0	32	20
600	24"	610	815	48.0	1.6	692.2	664	609.5	-	666.7	83	111	152	304.8	749.5	35	20

Note:

- Dimensions are in (mm)
- Larger sizes available on request
- Slip on bore is 0.76mm larger than pipe up to 250mm OD then 1.5mm
- Bore of long weld neck is to be nominal pipe size

10.06 | Flange Specification (ASME B16.5)

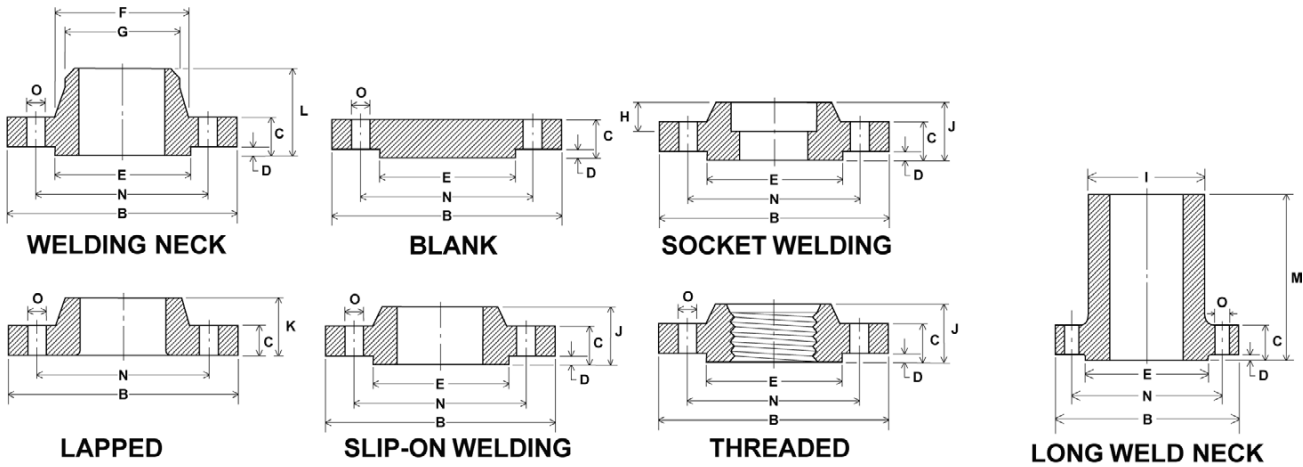

CLASS 300

Nominal Pipe Size		Outside Diameter of Pipe	Flange Outside Diameter	Thickness of Flange Min	Rasied Face Thickness	Rasied Face Diameter	Hub Diameter	Hub Dia. Start of Chamfer W. Neck	Socket Weld Depth	Hub Dia. Long Weld Neck	Length Through Hub			Drilling Data			
											Thread Slip on Socket Welding	Lapped	Welding Neck	Long Welding Neck	Bolt Circle Diameter	Diameter of Bolt Holes	Number of Bolts
mm	inch	A	B	C	D	E	F	G	H	I	J	K	L	M	N	O	P
15	1/2"	21.3	95	14.5	1.6	34.9	38	21.5	9.5	38.1	22	22	52	228.6	66.5	16	4
20	3/4"	26.7	117	16.5	1.6	42.9	48	26.5	11.1	47.6	25	25	57	228.6	82.5	20	4
25	1"	33.4	124	17.5	1.6	50.8	54	33.5	12.7	54.0	27	27	62	228.6	89.0	20	4
32	1 1/4"	42.2	133	19.5	1.6	63.5	64	42.0	14.2	63.5	27	27	65	228.6	98.5	20	4
40	1 1/2"	48.3	156	21.0	1.6	73.0	70	48.5	15.7	69.8	30	30	68	228.6	114.5	23	4
50	2"	60.3	165	22.5	1.6	92.1	84	60.5	17.6	84.1	33	33	70	228.6	127.0	20	8
65	2 1/2"	73	191	25.5	1.6	104.8	100	73.0	19.1	100.0	38	38	76	228.6	149.0	23	8
80	3"	88.9	210	29.0	1.6	127.0	118	89.0	20.6	117.5	43	43	79	228.6	168.5	23	8
100	4"	114.3	254	32.0	1.6	157.2	146	114.5	-	146.0	48	48	86	304.8	200.0	23	8
125	5"	141.3	279	35.0	1.6	185.7	178	141.5	-	177.8	51	51	98	304.8	235.0	23	8
150	6"	168.3	318	37.0	1.6	215.9	206	168.5	-	206.4	52	52	98	304.8	270.0	23	12
200	8"	219.1	381	41.5	1.6	269.9	260	219.0	-	260.3	62	56	111	304.8	330.0	26	12
250	10"	273.8	445	48.0	1.6	323.8	321	273.0	-	32.7	67	95	117	304.8	387.5	29	16
300	12"	323.8	520	51.0	1.6	381.0	375	324.0	-	374.6	73	102	130	304.8	451.0	32	16
350	14"	355.6	585	54.0	1.6	412.9	426	355.5	-	425.4	76	111	143	304.8	514.5	32	20
400	16"	406.4	650	57.5	1.6	469.9	483	406.5	-	482.6	83	121	146	304.8	571.5	35	20
450	18"	457	710	60.5	1.6	533.4	533	457.0	-	533.4	89	130	159	304.8	628.5	35	24
500	20"	508	775	63.5	1.6	584.2	587	508.0	-	587.3	95	140	162	304.8	686.0	35	24
600	24"	610	915	70.0	1.6	692.2	702	609.5	-	701.6	106	152	168	304.8	813.0	42	24

Note:

- Dimensions are in (mm)
- Larger sizes available on request
- Slip on bore is 0.76mm larger than pipe up to 250mm OD then 1.5mm
- Bore of long weld neck is to be nominal pipe size

10.07 | Flange Specification (ASME B16.5)

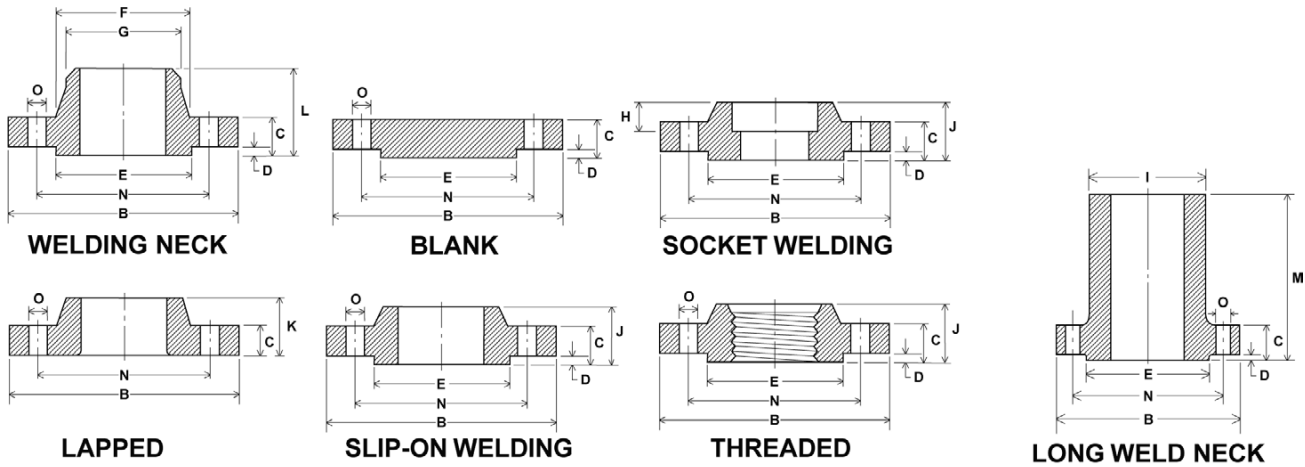

CLASS 600

Nominal Pipe Size		Outside Diameter of Pipe	Flange Outside Diameter	Thickness of Flange Min	Rasied Face Thickness	Rasied Face Diameter	Hub Diameter	Hub Dia. Start of Chamfer W. Neck	Socket Weld Depth	Hub Dia. Long Weld Neck	Length Through Hub			Drilling Data			
											Thread Slip on Socket Welding	Lapped	Welding Neck	Long Welding Neck	Bolt Circle Diameter	Diameter of Bolt Holes	Number of Bolts
mm	inch	A	B	C	D	E	F	G	H	I	J	K	L	M	N	O	P
15	1/2"	21.3	95	14.5	6.4	34.9	38	21.5	9.5	38.1	22	22	52	-	66.5	16	4
20	3/4"	26.7	117	16.0	6.4	42.9	48	26.5	11.1	47.6	25	25	57	-	82.5	20	4
25	1"	33.4	124	17.5	6.4	50.8	54	33.5	12.7	54.0	27	27	62	228.6	89.0	20	4
32	1 1/4"	42.2	133	21.0	6.4	63.5	64	42.0	14.2	63.5	29	29	67	228.6	98.5	20	4
40	1 1/2"	48.3	156	22.5	6.4	73.0	70	48.5	15.7	69.8	32	32	70	228.6	114.5	23	4
50	2"	60.3	165	25.5	6.4	92.1	84	60.5	17.5	84.1	37	37	73	228.6	127.0	20	8
65	2 1/2"	73	191	19.0	6.4	104.8	100	73.0	19.1	100.0	41	41	79	228.6	149.0	23	8
80	3"	88.9	210	32.0	6.4	127.0	117	89.0	20.6	117.5	46	46	83	228.6	168.0	23	8
100	4"	114.3	273	38.5	6.4	157.2	152	114.5	-	152.4	54	54	102	304.8	216.0	26	8
125	5"	141.3	330	44.5	6.4	185.7	189	141.5	-	190.5	60	60	114	304.8	267.0	29	8
150	6"	168.3	356	48.0	6.4	215.9	222	168.5	-	222.2	67	67	117	304.8	292.0	29	12
200	8"	219.1	419	55.5	6.4	269.9	273	219.0	-	273.0	76	76	133	304.8	349.0	32	12
250	10"	273.8	510	63.5	6.4	323.8	343	273.0	-	342.9	86	111	152	304.8	432.0	35	16
300	12"	323.8	560	67.0	6.4	381.0	400	324.0	-	400.0	92	117	156	304.8	489.0	35	20
350	14"	355.6	605	70.0	6.4	412.8	432	355.5	-	431.8	94	127	165	304.8	527.0	39	20
400	16"	406.4	685	76.5	6.4	469.9	495	406.5	-	495.3	106	140	178	304.8	603.0	42	20
450	18"	457	745	83.0	6.4	533.4	546	457.0	-	546.1	117	152	184	304.8	654.0	45	20
500	20"	508	815	89.0	6.4	584.2	610	508.0	-	609.6	127	165	190	304.8	724.0	45	24
600	24"	610	940	102.0	6.4	692.2	718	609.5	-	717.5	140	184	203	304.8	838.0	51	24

Note:

- Dimensions are in (mm)
- Larger sizes available on request
- Slip on bore is 0.76mm larger than pipe up to 250mm OD then 1.5mm
- Bore of long weld neck is to be nominal pipe size

10.08 | Flange Specification (EN 1092-1)

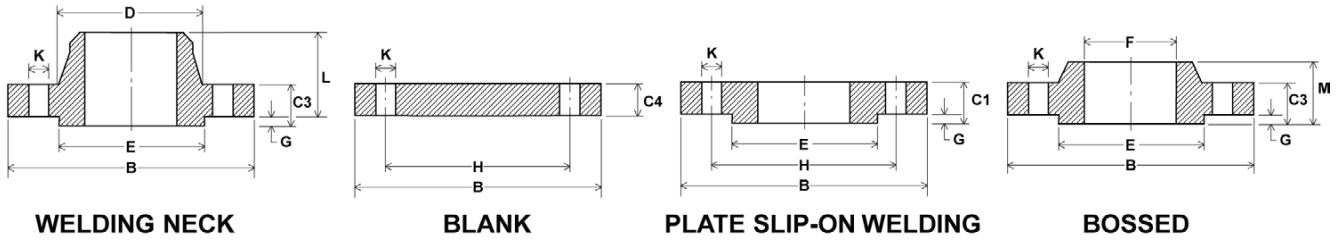

PN 6

Nominal Pipe Size		Outside Diameter of Pipe	Flange Outside Diameter	Thickness of Flange			Hub Diameter Weld Neck	Raised Face Diameter	Slip On Bore	Raised Face Thickness	Drilling Data			Length Through Hub	
				Plate	Bossed & Weld Neck	Blind					Bolt Circle Diameter	Diameter of Bolt Holes	Number of Bolts	Overall Thickness Weld Neck	Overall Thickness Bossed
mm	inch	A	B	C1	C2	C3	D	E	F	G	H	J	K	L	M
15	1/2"	21.3	80	12	12	12	30	40	22.3	2	55	11	4	30	12
20	3/4"	26.7	90	14	14	14	38	50	27.6	2	65	11	4	32	24
25	1"	33.4	100	14	14	14	42	60	34.5	2	75	11	4	35	24
32	1 1/4"	42.2	120	16	14	14	55	70	43.1	2	90	14	4	35	26
40	1 1/2"	48.3	130	16	14	14	62	80	49.5	3	100	14	4	38	26
50	2"	60.3	140	16	14	14	74	90	61.9	3	110	14	4	38	28
65	2 1/2"	73	160	16	14	14	88	110	74.6	3	130	14	4	38	32
80	3"	88.9	190	18	16	16	102	128	90.6	3	150	18	4	42	34
100	4"	114.3	210	18	16	16	130	148	116.0	3	170	18	4	45	40
125	5"	141.3	240	20	18	18	155	178	143.7	3	200	18	8	48	44
150	6"	168.3	265	20	18	18	187	202	170.6	3	225	18	8	48	44
200	8"	219.1	320	22	20	20	236	258	221.1	3	280	18	8	55	44
250	10"	273.8	375	24	22	22	290	312	276.3	3	335	18	12	60	44
300	12"	323.8	440	24	22	22	342	365	327.1	4	395	22	12	62	44
350	14"	355.6	490	26	22	22	385	415	358.6	4	445	22	12	62	-
400	16"	406.4	540	28	22	22	438	465	409.4	4	495	22	16	65	-
450	18"	457	595	30	22	22	492	520	460.4	4	550	22	16	65	-
500	20"	508	645	30	24	24	538	570	460.0	4	600	22	20	68	-
600	24"	610	755	32	30	30	640	670	511.0	5	705	26	20	70	-

Note:

- Dimensions are in (mm)
- Larger sizes available on request
- Available with or without raised face
- Weld neck bore is equal to pipe

10.09 | Flange Specification (EN 1092-1)

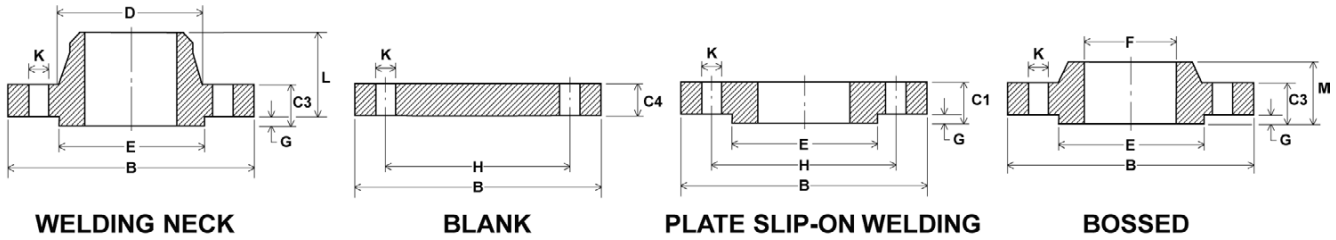

PN 10

Nominal Pipe Size		Outside Diameter of Pipe	Flange Outside Diameter	Thickness of Flange			Hub Diameter Weld Neck	Raised Face Diameter	Slip On Bore	Raised Face Thickness	Drilling Data			Length Through Hub	
				Plate	Bossed & Weld Neck	Blind					Bolt Circle Diameter	Diameter of Bolt Holes	Number of Bolts	Overall Thickness Weld Neck	Overall Thickness Bossed
mm	inch	A	B	C1	C2	C3	D	E	F	G	H	J	K	L	M
15	1/2"	21.3	95	14	16	16	32	45	22.3	2	65	14	4	22	22
20	3/4"	26.7	105	16	18	18	39	58	27.6	2	75	14	4	26	26
25	1"	33.4	115	16	18	18	46	68	34.5	2	85	14	4	28	28
32	1 1/4"	42.2	140	18	18	18	56	78	43.1	2	100	18	4	30	30
40	1 1/2"	48.3	150	18	18	18	64	88	49.5	3	110	18	4	32	32
50	2"	60.3	165	19	18	18	74	102	61.9	3	125	18	4	28	28
65	2 1/2"	73	185	20	18	18	92	122	74.6	3	145	18	4	32	32
80	3"	88.9	200	20	20	20	110	138	90.6	3	160	18	8	34	34
100	4"	114.3	220	22	20	20	130	158	116.0	3	180	18	8	40	40
125	5"	141.3	250	22	22	22	158	188	143.7	3	210	18	8	44	44
150	6"	168.3	285	24	22	22	184	212	170.6	3	240	22	8	44	44
200	8"	219.1	340	24	24	24	234	268	221.1	3	295	22	8	44	44
250	10"	273.8	395	26	26	26	288	320	276.3	3	350	22	12	46	46
300	12"	323.8	445	26	26	26	342	370	327.1	4	400	22	12	46	46
350	14"	355.6	505	30	26	26	390	430	358.6	4	460	22	16	53	53
400	16"	406.4	565	32	26	26	440	482	409.4	4	515	26	16	57	57
450	18"	457	615	36	28	28	488	532	460.4	4	565	26	20	63	63
500	20"	508	670	38	28	28	540	585	460.0	4	620	26	20	67	67
600	24"	610	780	42	30	34	640	685	511.0	5	725	30	20	75	75

Note:

- Dimensions are in (mm)
- Larger sizes available on request
- Available with or without raised face
- Weld neck bore is equal to pipe

10.10 | Flange Specification (EN 1092-1)

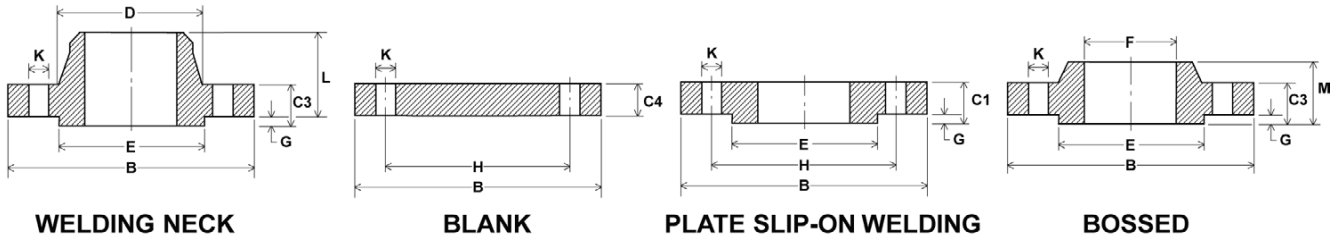

PN 16

Nominal Pipe Size		Outside Diameter of Pipe		55Thickness of Flange			Hub Diameter Weld Neck					Drilling Data			Length Through Hub	
				Plate	Bossed & Weld Neck	Blind						Bolt Circle Diameter	Diameter of Bolt Holes	Number of Bolts	Overall Thickness Weld Neck	Overall Thickness Bossed
mm	inch	A	B	C1	C2	C3	D	E	F	G	H	J	K	L	M	
15	1/2"	21.3	95	14	16	16	32	45	22.3	2	65	14	4	38	22	
20	3/4"	26.7	105	16	18	18	39	58	27.6	2	75	14	4	40	26	
25	1"	33.4	115	16	18	18	46	68	34.5	2	85	14	4	40	28	
32	1 1/4"	42.2	140	18	18	18	56	78	43.1	2	100	18	4	42	30	
40	1 1/2"	48.3	150	18	18	18	64	88	49.5	3	110	18	4	45	32	
50	2"	60.3	165	20	18	18	74	102	61.9	3	125	18	4	45	28	
65	2 1/2"	73	185	20	18	18	92	122	74.6	3	145	18	4 / 8	45	32	
80	3"	88.9	200	20	20	20	110	138	90.6	3	160	18	8	50	34	
100	4"	114.3	220	22	20	20	130	158	116.0	3	180	18	8	52	40	
125	5"	141.3	250	22	22	22	158	188	143.7	3	210	18	8	55	44	
150	6"	168.3	285	24	22	22	184	212	170.6	3	240	22	8	55	44	
200	8"	219.1	340	26	24	24	234	268	221.1	3	295	22	12	62	44	
250	10"	273.8	405	29	26	26	288	320	276.3	3	355	26	12	70	46	
300	12"	323.8	460	32	28	28	342	378	327.1	4	410	26	12	78	46	
350	14"	355.6	520	35	30	30	390	438	358.6	4	470	26	16	82	57	
400	16"	406.4	580	38	32	32	444	490	409.4	4	525	30	16	85	63	
450	18"	457	640	42	34	40	490	550	460.4	4	585	30	20	87	68	
500	20"	508	715	46	36	44	546	610	460.0	4	650	33	20	90	73	
600	24"	610	840	55	40	54	650	725	511.0	5	770	36	20	95	83	

Note:

- Dimensions are in (mm)
- Larger sizes available on request
- Available with or without rasied face
- Weld neck bore is equal to pipe

10.11 | Flange Specification (EN 1092-1)

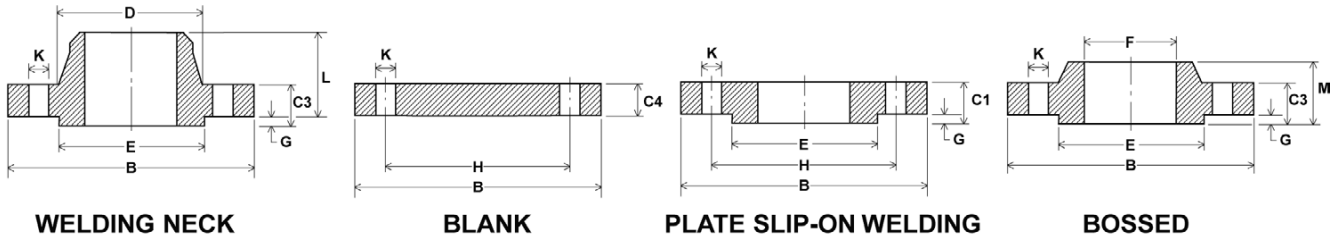

PN 25

Nominal Pipe Size		Outside Diameter of Pipe	Flange Outside Diameter	Thickness of Flange			Hub Diameter Weld Neck	Raised Face Diameter	Slip On Bore	Raised Face Thickness	Drilling Data			Length Through Hub	
				Plate	Bossed & Weld Neck	Blind					Bolt Circle Diameter	Diameter of Bolt Holes	Number of Bolts	Overall Thickness Weld Neck	Overall Thickness Bossed
mm	inch	A	B	C1	C2	C3	D	E	F	G	H	J	K	L	M
15	1/2"	21.3	95	14	16	16	32	45	22.3	2	65	14	4	38	22
20	3/4"	26.7	105	16	18	18	40	58	27.6	2	75	14	4	40	26
25	1"	33.4	115	16	18	18	46	68	34.5	2	85	14	4	40	28
32	1 1/4"	42.2	140	18	18	18	56	78	43.1	2	100	18	4	42	30
40	1 1/2"	48.3	150	18	18	18	64	88	49.5	3	110	18	4	45	32
50	2"	60.3	165	20	20	20	74	102	61.9	3	125	18	4	48	34
65	2 1/2"	73	185	22	22	22	92	122	74.6	3	145	18	8	52	38
80	3"	88.9	200	24	24	24	110	138	90.6	3	160	18	8	58	40
100	4"	114.3	235	26	24	24	134	162	116.0	3	190	22	8	65	44
125	5"	141.3	270	28	26	26	162	188	143.7	3	220	26	8	68	48
150	6"	168.3	300	30	28	28	190	218	170.6	3	250	26	8	75	52
200	8"	219.1	360	32	30	30	244	278	221.1	3	310	26	12	80	52
250	10"	273.8	425	35	32	32	296	335	276.3	3	370	30	12	88	60
300	12"	323.8	485	38	34	34	350	395	327.1	4	430	30	16	92	67
350	14"	355.6	555	42	38	38	398	450	358.6	4	490	33	16	100	72
400	16"	406.4	620	48	40	40	452	505	409.4	4	550	36	16	110	78
450	18"	457	670	54	46	50	500	555	460.4	4	600	36	20	110	84
500	20"	508	730	58	48	51	558	615	460.0	4	660	36	20	125	90
600	24"	610	845	68	48	66	660	720	511.0	5	770	39	20	125	100

Note:

- Dimensions are in (mm)
- Larger sizes available on request
- Available with or without raised face
- Weld neck bore is equal to pipe

10.12 | Flange Specification (EN 1092-1)

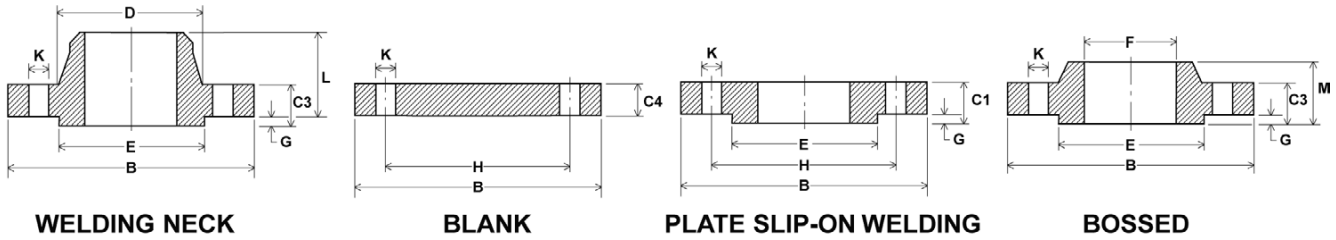

PN 40

Nominal Pipe Size		Outside Diameter of Pipe	Flange Outside Diameter	Thickness of Flange			Hub Diameter Weld Neck	Raised Face Diameter	Slip On Bore	Raised Face Thickness	Drilling Data			Length Through Hub	
				Plate	Bossed & Weld Neck	Blind					Bolt Circle Diameter	Diameter of Bolt Holes	Number of Bolts	Overall Thickness Weld Neck	Overall Thickness Bossed
mm	inch	A	B	C1	C2	C3	D	E	F	G	H	J	K	L	M
15	1/2"	21.3	95	14	16	16	32	45	22.3	2	65	14	4	38	22
20	3/4"	26.7	105	16	18	18	40	58	27.6	2	75	14	4	40	26
25	1"	33.4	115	16	18	18	46	68	34.5	2	85	14	4	40	28
32	1 1/4"	42.2	140	18	18	18	56	78	43.1	2	100	18	4	42	30
40	1 1/2"	48.3	150	18	18	18	64	88	49.5	3	110	18	4	45	32
50	2"	60.3	165	20	20	20	74	102	61.9	3	125	18	4	48	34
65	2 1/2"	73	185	22	22	22	92	122	74.6	3	145	18	8	52	38
80	3"	88.9	200	24	24	24	110	138	90.6	3	160	18	8	58	40
100	4"	114.3	235	26	24	24	134	162	116.0	3	190	22	8	65	44
125	5"	141.3	270	28	26	26	162	188	143.7	3	220	26	8	68	48
150	6"	168.3	300	30	28	28	190	218	170.6	3	250	26	8	75	52
200	8"	219.1	375	36	34	36	244	285	221.1	3	320	30	12	88	52
250	10"	273.8	450	42	38	38	306	345	276.3	3	385	33	12	105	60
300	12"	323.8	515	52	42	42	362	410	327.1	4	450	33	16	115	67
350	14"	355.6	580	58	46	46	408	465	358.6	4	510	36	16	125	72
400	16"	406.4	660	65	50	50	462	535	409.4	4	585	39	16	135	78
450	18"	457	685	66	57	57	500	560	460.4	4	610	39	20	135	84
500	20"	508	755	72	57	57	562	615	460.0	4	670	42	20	140	90
600	24"	610	890	84	72	72	666	735	511.0	5	795	48	20	150	100

Note:

- Dimensions are in (mm)
- Larger sizes available on request
- Available with or without raised face
- Weld neck bore is equal to pipe

10.13 Chemical Compatibility Table

Media	Chemical Formula	Metals											Elastomers						Polymers									
		Aluminum	Brass	Carbon Steel	Ductile Iron / Cast Iron	316/316Ti/321 S5t	17-4PH	Alloy 20	Monel	Hastelloy C ^o	Inconel 625	Titanium	Bronze	304 Stainless Steel	Duplex	Buna N (Nitrile)	EPDM/EPR	Viton	Flexible Graphite	Delrin [®]	PEEK [®]	PVDF	Teflon [®] and Reinforced	Teflon	PCTFE	UHMWPE [®]	Vespe [®]	PFA
Acetaldehyde	C ₂ H ₄ O	B	B	C	C	A	A	A	A	A	A	A	A	A	D	A	D	A	A	A	B	D	A	A	A	A	A	A
Acetamine	HCl	B	B	B	B	B																						
Acetate Solvents	-	A	A	D	B	A	A																					
Acetic Acid (aerated)	C ₂ H ₄ O ₂	C	D	D	C	A	A	A	A	A	A	A	A	A	C	A	D	A	D	A	A							
Acetic Acid (air free)	C ₂ H ₄ O ₂	C	D	D	C	A	A	A	A	A	A	A	A	A	C	A	D	A	D	A	A							
Acetic Acid (crude)	C ₂ H ₄ O ₂	C	D	D	D	A	A	A	A	A	A	A	A	A	C	A	D	A	D	A	A							
Acetic Acid Glacial	C ₂ H ₄ O ₂	C	D	D	D	A	A	A	A	A	A	A	A	A	C	A	D	A	D	A	A							
Acetic Acid (pure)	C ₂ H ₄ O ₂	C	D	D	D	A	A	A	A	A	A	A	A	A	C	A	D	A	D	A	A							
Acetic Acid 10%	C ₂ H ₄ O ₂	C	D	D	D	A	A	A	A	A	A	A	A	A	C	A	D	A	D	A	A							
Acetic Acid 80%	C ₂ H ₄ O ₂	C	D	D	D	A	A	A	A	A	A	A	A	A	C	A	D	A	D	A	A							
Acetic Acid Vapors	-	B	D				C	C	B	C	A																	
Acetic Anhydride	C ₄ H ₆ O ₃	C	D	D	D	B	B	B	B	A	A	A	C	B	D	C	D	A	D	A	D							
Acetone	C ₃ H ₆ O	A	A	A	A	A	A	A	A	A	A	A	A	A	A	A	D	A	D	A	D							
Other Ketones	RC(=O)R'	A	A	A	A	A	A	A	A	A	A	A	A	A	A	A	D	A	D	A	D							
Acetyl Chloride	CH ₃ COCl	C	B	A	C	A	A	A	A	A	A		D	C	D	D	D	D	B	B	D							
Acetylene	C ₂ H ₂	A	C	A	A	A	A	A	A	A	A		B	C	A	A	A	A	A	A	A							
Acid Fumes	-	B	D	D	D	B																						
Acrylonitrile	C ₃ H ₃ N	B	A	A	C	A	A	A	A	A	A		B	A	A	D	D	B	D	A	B							
Air	-	A	A	A	A	A	A	A	A	A	A		A	A	A	A	A	A	A	A	A							
Alcohol, Amyl	C ₅ H ₁₁ OH	B	B	B	B	A	B	B	B	B	A		A	B	A	C	A	B	A	A	A							
Alcohol, Butyl	C ₄ H ₉ OH	A	B	B	C	A	B	A	A	A	B		B	A	B	B	A	B	A	A	A							
Alcohol, Diacetone	CH ₃ C(O)CH ₂ C(O)CH ₃	A	B	B	B	A	B	A	A	A	A		A	B	A	D	A	D	A	A	A							
Alcohol, Ethyl	C ₂ H ₅ O	B	B	B	B	A	B	A	A	A	A		A	B	A	A	A	A	A	B	A							
Alcohol, Fatty	-	B	B	B	B	B	A	B	A	A	B		B	A	B	B	B	A	A	A	A							
Alcohol, Isopropyl	C ₃ H ₈ O	B	B	B	B	B	B	B	B	A	B		B	B	A	C	A	A	A	A	A							
Alcohol, Methyl	CH ₄ O	C	B	B	B	A	B	A	A	A	A		A	B	A	B	A	C	A	B	A							
Alcohol, Propyl	C ₃ H ₈ O	B	B	B	B	A	B	A	A	A	A		A	B	A	A	A	A	A	A	A							
Alumunia	-	A	A																									
Aluminum Acetate	Al(C ₂ H ₃ O ₂) ₃	C	C																									
Aluminum Chloride (dry)	AlCl ₃	C	D	D	D	C	B	B	A	A	C		D	D	B	A	A	A	A	C	A							
Aluminum Chloride Solution	-	B	D	D	D	D	C	B	B	A	B		D	C	B	A	A	A	A	D	A							

Ratings: A - Excellent B - Good C - Poor D - Do not use Blank - No information

Media	Chemical Formula	Metals										Elastomers					Polymers											
		Aluminum	Brass	Carbon Steel	Ductile Iron / Cast Iron	316/316Ti/321 S.S	17-4PH	Alloy 20	Monel	Hastelloy C	Inconel 625	Titanium	Bronze	304 Stainless Steel	Duplex	Buna N (Nitrile)	EPDM/EPR	Viton	Flexible Graphite	Delrin	Peek	PVDF	Teflon and Reinforced Teflon	PCTFE	UHMWPE	Vespe	PFA	KEL-F
Aluminum Fluoride	AlF ₃	C	D	D	D	C	C	B	A	B	C	C	D	D	A	A	A	A	C	C	A	A	A	A	A	A	A	A
Aluminum Hydroxide	Al(OH) ₃	B	D	D	D	A	A	A	B	A	B	D	A	A	A	A	A	A	A	B	B	A	A	A	A	A	A	B
Aluminum Nitrate	Al(NO ₃) ₃	D	D	D	D	B	A	A	C	B	A	D	C		B	B	D	A	A	C		B						B
Aluminum Oxalate	C ₆ AlO ₁₂ .3	B		B	A																							A
Aluminum Potassium Sulfate	AlK ₂ O ₈ S ₂	B	B	C	D	B	C	B	B	C	A	C	C		B	A	B	A	A	C			A	A	A	A	A	A
Aluminum Sulfate (Alum)	Al ₂ O ₁₂ S ₃	C	C	D	D	B	B	B	C	B	A	C	B		A	A	A	A	C			A	A	A	A	A	A	A
Amines	R ₃ -NH ₂	C	B	C	B	A	A	A	B	A	B	C	B		B	C	D	A	A	D								A
Ammonia Alum	AlH ₂₈ NO ₂₀ S ₂	C		C	A	A	B	A	B	A	B	C	B		B	B	D	A	A	C								A
Ammonia, Anh. Liquid	NH ₃	A	D	A	B	A	A	A	A	B	B	D	B		B	B	D	A	A	D								A
Ammonia Aqueous	H ₅ NO	B	C	C	C	A	A	A	B	A	B	D	A		B	D	C	A	A	D								A
Ammonia Gas (hot)	H ₃ N	B	C	B	B	A	A	A	A	A	B	D	C		A	D	A	A	D									A
Ammonia Liquor	-	A	C	A	B	B	A	A	A	B	B	D	C		A	D	A	A	D									A
Ammonia Solutions	-	B	D	B	C	A	A	A	A	A	B	D			D	A	D	A	D									A
Ammonium Acetate	C ₂ H ₃ O ₂ NH ₄	A	D	D	D	B	A	A	B	A	B	D	B		C	A	D	A	D									A
Ammonium Bicarbonate	NH ₄ HCO ₃	B	B	C	C	B	B	B	B	B	B	B			C	A	D	A	D									A
Ammonium Bromide 5%	NH ₄ Br	D				B	B	B	B	B	B	B			B	A	A	A	B									A
Ammonium Carbonate	(NH ₄) ₂ CO ₃	B	D	B	B	B	B	B	B	B	B	B			C	A	B	A	D									A
Ammonium Chloride	NH ₄ Cl	C	C	D	D	C	C	B	B	B	B	D			B	A	A	A	C									A
Ammonium Hydroxide 28%	NH ₄ OH	C	D	C	B	B	A	A	B	B	B	D			B	A	B	A	C									A
Ammonium Hydroxide Conc.	NH ₄ OH	C	D	C	B	B	A	A	C	B	B	D			C	A	B	A	D									A
Ammonium Monosulfate	-	D				B	A	B	B	B	B				D				D									A
Ammonium Nitrate	(NH ₄)NO ₃	B	D	D	B	A	A	A	A	A	A	D			A	A	B	A	C									A
Ammonium Oxalate 5%	C ₂ H ₈ N ₂ O ₄	A		A	D	A	A	A	B	A	B	D			D	A	A	A	D									A
Ammonium Persulfate	H ₈ N ₂ O ₈ S ₂	D	D	C	D	A	A	A	D	B	B	C			D	B	B	A	D									A
Ammonium Phosphate (mono)	(NH ₄) ₃ PO ₄	B	C	D	D	B	A	A	C	A	A	C			C	A	A	A	B									A
Ammonium Phosphate Di-basic	(NH ₄) ₂ HPO ₄	B	C	D	C	B	B	C	A	A	A	D			A	A	A	A	B									A
Ammonium Phosphate Tri-basic	-	B	C	D	C	B	B	C	A	A	C	B			A	A	A	A	B									A
Ammonium Sulfate	(NH ₄) ₂ SO ₄	C	D	C	C	B	B	C	A	B	B	A			A	A	C	A	C									A
Ammonium Sulfide	(NH ₄) ₂ S	B	D	D	D	B	B	B	B	A	B	D			B	A	C	A	C									A
Ammonium Sulfite	(NH ₄) ₂ SO ₃	D	C	C	C	A	B	B	D	A	A	B			B	B	C	D	D									A
Amyl Acetate	CH ₃ COO(CH ₂) ₄ CH ₃	A	A	C	C	B	A	A	A	A	A	A			D	B	C	A	C									A

Ratings: A - Excellent B - Good C - Poor D - Do not use Blank - No information

10.15 Chemical Compatibility Table

Media	Chemical Formula	Metals										Elastomers					Polymers											
		Aluminum	Brass	Carbon Steel	Ductile Iron / Cast Iron	316/316Ti/321 SS	17-4PH	Alloy 20	Monel	Hastelloy C	Inconel 625	Titanium	Bronze	304 Stainless Steel	Duplex	Buna N (Nitrile)	EPDM/EPR	Viton	Flexible Graphite	Delrin	Peek	PVDF	Teflon and Reinforced Teflon	PTFE	UHMWPE	Vespe	PFA	KEL-F
Amyl Chloride	C ₅ H ₁₁ Cl	B	B	A	B	B	B	A	A	A	A	A	A	A	D	D	D	D	D	D	A	A	A	A	A	A	A	A
Aniline	C ₆ H ₇ N	C	D	C	C	A	A	A	B	B	C	C	A	A	D	D	C	C	A	A	B	A	B	A	A	A	A	A
Aniline Dyes	-	C	C	C	C	A	A	A	A	A	A	A	A	A	A	A	A	A	A	A	A	A	A	A	A	A	A	A
Apple Juice	-	B	C	D	D	B	C	A	A	A	A	A	A	A	D	D	D	D	D	D	A	A	A	A	A	A	A	A
Aqua Regia (Strong Acid)	-	D	D	D	D	C	C	B	C	C	C	C	C	C	D	D	D	D	D	D	A	A	A	A	A	A	A	A
Aromatic Solvents	-	A	A	C	B	A	A	A	A	A	A	A	A	A	A	A	A	A	A	A	A	A	A	A	A	A	A	A
Asenic Acid	AsH ₃ O ₄	D	C	D	D	B	A	A	B	B	C	A	A	A	A	A	A	A	A	A	A	A	A	A	A	A	A	A
Asphalt Emulsion	-	C	B	B	B	A	A	A	A	A	A	A	A	A	D	D	A	A	A	A	B	A	A	A	A	A	A	A
Asphalt Liquid	-	C	B	B	B	A	A	A	A	A	A	A	A	A	C	D	A	A	A	A	B	A	A	A	A	A	A	A
Barium Carbonate	CBaO ₃	C	B	B	B	A	A	A	A	A	A	A	A	A	B	A	A	A	A	A	A	A	A	A	A	A	A	A
Barium Chloride	BaCl ₂	D	B	C	C	B	A	A	A	A	A	A	A	A	A	A	A	A	A	A	A	A	A	A	A	A	A	A
Barium Cyanide	Ba(CN) ₂	D	C	C	C	B	A	A	B	C	A	A	A	A	B	A	A	A	A	A	B	A	A	A	A	A	A	A
Barium Hydroxide	BaH ₂ O ₂	D	D	C	C	A	A	A	A	A	B	B	D	B	A	A	A	A	A	A	A	A	A	A	A	A	A	A
Barium Hydroxide	Ba(OH) ₂	D	D	C	C	A	A	A	A	A	B	B	D	B	A	A	A	A	A	A	A	A	A	A	A	A	A	A
Barium Nitrate	Ba(NO ₃) ₂	B	D	A	A	A	B	A	A	A	A	A	A	A	A	A	A	A	A	A	B	A	A	A	A	A	A	A
Barium Sulfate	BaSO ₄	C	B	B	C	B	A	A	A	A	A	A	A	A	C	C	A	A	A	A	B	A	A	A	A	A	A	A
Barium Sulfide	BaS	D	C	C	C	B	A	A	A	A	A	A	A	A	C	C	A	A	A	A	A	A	A	A	A	A	A	A
Beer	-	A	B	C	C	D	A	A	A	A	A	A	A	A	A	A	A	A	A	A	A	A	A	A	A	A	A	A
Beet Sugar Liquors	-	A	B	B	B	A	A	A	A	A	A	A	A	A	A	A	A	A	A	A	A	A	A	A	A	A	A	A
Benzaldehyde	C ₇ H ₆ O	B	B	B	C	A	A	A	A	A	A	A	A	A	C	D	A	A	A	A	A	A	A	A	A	A	A	A
Benzene (Benzol)	C ₆ H ₆	B	A	B	B	A	A	A	A	A	A	A	A	A	B	D	A	A	A	A	A	A	A	A	A	A	A	B
Benzoic Acid	C ₇ H ₆ O ₂	B	C	D	D	B	A	A	A	A	A	A	A	A	C	D	A	A	A	A	B	A	A	A	A	A	A	A
Beryllium Sulfate	BeO ₄ S	B	B	B	B	B	A	A	A	A	A	A	A	A	B	B	B	B	B	B	A	A	A	A	A	A	A	A
Bleaching Powder Wet	-	B	B	C	C	C	C	B	A	A	A	A	A	A	B	D	B	B	B	B	B	A	A	A	A	A	A	A
Blood (meat juices)	-	B	B	D	D	A	A	A	A	A	A	A	A	A	A	A	B	B	B	B	B	A	A	A	A	A	A	A
Borax (Sodium Borate)	Na ₂ B ₄ O ₇ ·10H ₂ O	C	B	C	A	A	A	A	A	A	A	A	A	A	A	A	A	A	A	A	A	A	A	A	A	A	A	A
Bordeaux Mixture	-	C	A	C	C	B	A	A	A	A	A	A	A	A	A	A	A	A	A	A	A	A	A	A	A	A	A	A
Borax Liquors	-	C	C	D	D	C	B	A	A	A	A	A	A	A	A	A	A	A	A	A	A	A	A	A	A	A	A	A
Boric Acid	BH ₃ O ₃	B	B	A	B	A	A	A	A	A	A	A	A	A	A	D	B	D	D	D	B	A	A	A	A	A	A	A
Brake Fluid	-	C	B	C	C	B	A	A	A	A	A	A	A	A	A	B	D	D	D	D	B	A	A	A	A	A	A	A
Brines (saturated)	-	C	B	C	C	B	B	B	B	B	B	B	B	B	A	A	A	A	A	A	A	A	A	A	A	A	A	A

Ratings: A - Excellent B - Good C - Poor D - Do not use Blank - No information

Media	Chemical Formula	Metals												Elastomers					Polymers										
		Aluminum	Brass	Carbon Steel	Ductile Iron / Cast Iron	316/316Ti/321 S5t	17-4PH	Alloy 20	Monel	Hastelloy C ^o	Inconel 625	Titanium	Bronze	304 Stainless Steel	Duplex	Buna N (Nitrile)	EPDM/EPR	Viton	Flexible Graphite	Delrin [®]	Peek [®]	PVDF	Teflon [®] and Reinforced	PCTFE	UHMWPE [®]	Vespe [®]	PFA	KEL-F [®]	
Bromine (dry)	Br	D	C	D	D	D	C	B	B	A	A	B	D	D	D	D	D	D	D	D	D	A	A	A	D		A	A	
Bunker Oils (Fuel)	-	A	B	A	B	A		A	A	A		A	A	A		B	C	A	A	A	A	A	A				A		
Butadiene	C ₄ H ₆	A	B	B	B	A	A	A	A	B		A	A	A		C	C	A	A	A	A	A	A				A		
Butane	C ₄ H ₁₀	A	A	B	C	A	A	A	A	A		A	A	A		B	D	A	A	A	A	A	A		A		A		
Butter	-	A			D	A		A								B	A	A	A	A	A	A							
Buttermilk	-	A	D	D	D	A		A	D	A						A	B	A	A	A	A	A						A	
Butyl Acetate	C ₆ H ₁₂ O ₂	B	B	B	B	A	A	A	A	A		B	B	A		D	D	D	A	A	A	A	A		A		A		
Butylene	C ₄ H ₈	A	A	A	A	A	A	A	A	A		A	A	A		D	D	D	A	A	A	A	A		A		A	C	
Butyric Acid	C ₄ H ₈ O ₂	B	B	D	D	B	A	A	A	A		A	C	C		C	C	C	A	B	A	A	A		A		A		
Calcium Bisulfite	CaH ₂ O ₆ S ₂	C	D	D	D	B	B	A	D	B		A	C	B		A	D	A	A	D	A	A	A				A		
Calcium Carbonate	CaCO ₃	C	D	C	D	B	A	A	A	A		A	C	A		B	B	A	A	A	A	A	A				A		
Calcium Chlorate	Ca(ClO ₃) ₂	B	C	B	C	B	B	A	A	A		B	B	B		B	B	B	B	C	A	A	A						
Calcium Chloride	CaCl ₂	D	C	C	C	B	B	A	A	A		A	B	C		A	A	A	D	A	A	A	A		A		A		
Calcium Hydroxide	Ca(OH) ₂	C	D	C	C	B	A	A	A	A		A	C	B		A	A	A	A	D	A	A	A				A		
Calcium Nitrate	Ca(NO ₃) ₂	C	B	B	C	B	B	A	A	B		B	B	C		B	B	A	B	D	A	A	A		A		A	B	
Calcium Phosphate	Ca ₃ (PO ₄) ₂	D	C		C	C	B	B								B	B	B	B	B									
Calcium Silicate	Ca ₂ SiO ₄	D	C		C	C	B	B								B	B	B	B	B									
Calcium Sulfate	CaO ₄ S	C	B	B	C	C	A	A	A	B		A	B	B		A	B	A	A	D	A	A	A				A	A	
Caliche Liquor	-															B													
Camphor	C ₁₀ H ₁₆ O	C	C	B	C	B	A	A	C							B	B	B	B	A	A	A							
Cane Sugar Liquors	C ₁₂ H ₂₂ O ₁₁	B	B	A	B	A	A	A	A	A						B	B	B	B	A	A	A							
Carbonated Beverages	-	B	B	D	B	B	B	B	C	A						B	B	B	A	A	A	A							
Carbonated Water	-	A	D	B	C	A	B	A	B							A	A	A	A	A	A	A							
Carbon Bisulfide	CS ₂	B	C	B	B	B	A	B	B	B						D	D	A	A	A	A	A							
Carbon Dioxide (dry)	CO ₂	B	B	B	B	A	A	A	A	A						A	C	B	B	A	A	A	A				A	A	
Carbonic Acid	CH ₂ O ₃	A	D	B	D	B	A	A	A	B						B	B	A	A	B	A	A	A				A	A	
Carbon Monoxide	CO	A	A	B	C	A	A	A	A	A						B	B	B	A	A	A	A	A				A	A	
Carbon Tetrachloride (dry)	CCl ₄	C	B	C	C	A	A	A	A	A						D	D	B	B	B	A	A	A				A	B	
Carbon Tetrachloride (wet)	CCl ₄	D	C	D	D	B	A	B	A	A						D	D	B	B	B	A	A	A				A	A	
Casein	-	C	C		C	B		B	C	B						B	B	B	B	A	A	A							
Castor Oil	-	A	A	A	A	A	A	A	A	A						A	B	A	A	A	A	A	A				A	A	

Ratings: A - Excellent B - Good C - Poor D - Do not use Blank - No information

Media	Chemical Formula	Metals										Elastomers					Polymers											
		Aluminum	Brass	Carbon Steel	Ductile Iron / Cast Iron	316/316Ti/321 SS	17-4PH	Alloy 20	Monel	Hastelloy C	Inconel 625	Titanium	Bronze	304 Stainless Steel	Duplex	Buna N (Nitrile)	EPDM/EPR	Viton	Flexible Graphite	Delrin	Peek	PVDF	Teflon and Reinforced Teflon	PTFE	UHMWPE	Vespe	PFA	KEL-F
Caustic Potash	HKO	C	C	B	B	A	A	A	A	A	A	A	A	A	A	A	A	A	A	A	A	A	A	A	A	A	A	A
Caustic Soda	HNao	D	D	B	B	A	A	A	A	A	A	A	A	A	A	A	A	A	A	A	A	A	A	A	A	A	A	A
Cellulose Acetate	-	B	B			B	B																					
China Wood Oil (Tung)	-	A	C	C	C	A	A	A	A	A	A	A	A	A	A	A	A	A	A	A	A	A	A	A	A	A	A	A
Chlorinated Solvents	-	C	C	C	C	C	C	C	C	C	C	C	C	C	C	C	C	C	C	C	C	C	C	C	C	C	C	C
Chlorinated Water		D	D	C	D	C	C	A	C	B	A	A	A	A	A	A	A	A	A	A	A	A	A	A	A	A	A	A
Chlorine Gas (dry)	Cl ₂	C	D	C	B	B	A	A	A	A	A	A	A	A	A	A	A	A	A	A	A	A	A	A	A	A	A	A
Chlorobenzene (dry)	C ₆ H ₅ Cl	B	B	C	A	A	A	A	A	A	A	A	A	A	A	A	A	A	A	A	A	A	A	A	A	A	A	A
Chloroform (dry)	CHCl ₃	C	B	C	C	A	A	A	A	A	A	A	A	A	A	A	A	A	A	A	A	A	A	A	A	A	A	A
Chlorophyll (dry)	-	B	B			B	B																					
Chlorosulfonic Acid (dry)	HSO ₃ Cl	C	C	C	B	C	C	B	A	B	A	A	A	A	A	A	A	A	A	A	A	A	A	A	A	A	A	A
Chrome Alum	CrK ₂ O ₈ S ₂	C	C	B	C	A	A	B																				
Chromic Acid <50%	CrH ₂ O ₄	D	D	D	D	C	B	C	C	C	A	D	B															
Chromic Acid >50%	CrH ₂ O ₄	D	D	D	D	C	C	D	C	B	D	D	C															
Chromium Sulfate	Cr ₂ O ₁₂ S ₃	B	C	D	D	B	B	C	B	B	B	B	B															
Cider	-	B				D	A	A	B	A	A	A	A															
Citric Acid	C ₆ H ₈ O ₇	C	D	D	D	C	A	A	A	A	A	A	D															
Citrus Juices	-	C	B	D	D	B	A	A	A	A	A	A	B															
Coca Cola Syrup	-					A	A	A	A	A	A	A	A															
Coconut Oil	-	B	B	C	C	A	A	A	B	A	A	B	A															
Coffee	-	A	A	C	C	A	A	B	A	A	A	A	A															
Coffee Extracts (hot)	-	A	A	C	C	A	A	A	A	A	A	A	A															
Coke Oven Gas	-	A	C	B	B	A	A	B																				
Cooking Oil	-	B	B	B	B	A	A	A	A	A	A	A	A															
Copper Acetate	C ₄ H ₆ CuO ₄	D	D	C	D	A	A	B	A	A	A	C																
Copper Carbonate	CCuO ₃	D				A	A	A	A	A	A	A																
Copper Cyanide	CCuN	D	D	C	D	A	A	C	A	C	A	A	B															
Copper Nitrate	Cu(NO ₃) ₂	D	D	D	D	B	A	D	B	B	D	A																
Copper Sulfate	CuO ₄ S	D	D	D	D	B	A	A	D	A	A	D																
Corn Oil	-	B	B	B	C	B	A	A	B	A	A	B																
Cotton seed Oil	-	B	B	B	C	B	A	A	B	A	A	B																

Ratings: A - Excellent B - Good C - Poor D - Do not use Blank - No information

Media	Chemical Formula	Metals												Elastomers					Polymers										
		Aluminum	Brass	Carbon Steel	Ductile Iron / Cast Iron	316/316Ti/321 S5t	17-4PH	Alloy 20	Monel	Hastelloy C ^o	Inconel 625	Titanium	Bronze	304 Stainless Steel	Duplex	Buna N (Nitrile)	EPDM/EPR	Viton	Flexible Graphite	Delrin [®]	PEEK [®]	PVDF	Teflon [®] and Reinforced	Teflon	PCTFE	UHMWPE [®]	VespeI [®]	PFA	KEL-F [®]
Cresol	C ₇ H ₈ O	A	C	A	C	B	A	B	B	B	A	A	A	A	D	D	D	A	D	D	D	B	A	A	A	A			
Creosote Oil	-	B	B	B	A	A	A	A	A	A	A	A	A	A	C	C	D	A	D	A	A	A	A	A	A	A			
Cresylic Acid	C ₇ H ₈ O	C	B	C	D	B	A	A	A	A	A	A	A	A	D	D	B	A	D	A	A	C	A	A	A	A			
Crude Oil, sour	-	A	C	C	C	B	A	A	A	A	A	A	A	A	A	A	D	A	A	A	A	A	A	A	A	A			
Crude Oil, sweet	-	A	B	A	B	A	A	A	A	A	A	A	A	A	A	A	D	A	A	A	A	A	A	A	A	A			
Cupric Nitrate	CuN ₂ O ₆	D																											
Cutting Oils, Water Emulsions	-	A	A	B	B	A	A	A	A	A	A	A	A	A	A	A	A	A	A	A	A	A	A	A	A	A			
Cyanide Plating Solution	-	D	D		D	B	B	D	A	A	A	A	A	A	A	B	B	B	D	D	A	A	A	A	A	A			
Cyclohexane	C ₆ H ₁₂	A	A	A	A	A	A	A	A	A	A	A	A	A	A	A	C	D	A	A	A	A	A	A	A	A	A		
Cyclohexanone	C ₈ H ₁₆ O	A	B	B	B	A	A	A	B	B	B	B	B	B	D	B	D	A	A	A	A	C	A	A	A	A	A		
Detergents, Synthetic	-	B	B	A	B	B	A	A	A	A	A	A	A	A	B	B	A	A	A	A	A	A	A	A	A	A	A		
Dextrin	C ₁₈ H ₃₂ O ₁₆	B	A	B	B	B	B	A	B	A	A	A	A	A	B	B	B	A	A	A	A	A	A	A	A	A			
Dichloroethane	C ₂ H ₄ Cl ₂	B	B		C	A	B	B	B	B	B	B	B	B	D	D	B	B	A	B	A	A	A	A	A	A			
Dichloroethyl Ether	C ₄ H ₈ Cl ₂ O	B	B	A	B	B	B	B	A	B	B	B	B	B	D	D	B	B	A	B	A	A	A	A	A	A			
Diesel Oil Fuels	-	A	A	A	A	A	A	A	A	A	A	A	A	A	C	A	D	A	A	A	A	B	A	A	A	A	A		
Diethylamine	C ₄ H ₁₁ N	B	C	C	C	B	A	A	A	A	A	A	A	B	C	D	A	A	B	A	B	A	B	A	B	A			
Diethyl Benzene	-																												
Diethylene Glycol	C ₄ H ₁₀ O ₃	B	B	A	A	A	B	A	B	B	B	B	B	B	D	D	B	B	A	B	A	A	A	A	A	A			
Diethyl Sulfate	(C ₂ H ₅) ₂ SO ₄	A	B	A	B	B	B	B	A	B	B	B	B	B	C	C	B	B	A	A	A	A	A	A	A	A			
Dimethyl Formamide	C ₃ H ₇ NO	B	B	B	B	B	A	A	A	A	A	A	A	A	B	B	D	D	C	A	A	A	A	A	A	A			
Dimethyl Phthalate	C ₁₀ H ₁₀ O ₄	B	A	A	B	B	A	A	A	A	A	A	A	A	B	B	D	D	C	A	A	A	A	A	A	A			
Dioxane	C ₄ H ₈ O ₂	B	A	A	B	B	A	B	A	A	A	A	A	A	B	B	D	D	C	A	A	A	A	A	A	A			
Dipentane (Pinene)	C ₁₀ H ₁₆	A	A		A	A	A	A																					
Disodium Phosphate	HNazO ₄ P	B	B	B	B	B	A	A	B	B	B	B	B	B	B	B	B	B	A	A	A	A	A	A	A	A			
Dowtherm	C ₂₄ H ₂₀ O	A	A	B	B	A	A	A	A	A	A	A	A	A	D	D	A	A	A	A	A	A	A	A	A	A			
Drilling Mud	-	B	B	A	A	A	A	A	A	A	A	A	A	A	B	A	A	A	A	A	A	A	A	A	A	A			
Dry Cleaning Fluids	-	A	C	B	B	A	A	A	A	A	A	A	A	A	B	A	B	A	D	D	A	A	A	A	A	A			
Drying Oil	-	C	C	C	B	B									B	A	A												
Enamel	-	A																											
Epsom Salts	MgO ₄ S	B	A	C	A	B	A	B	B	B	B	B	B	B	B	A	A	A	A	B	B	A	A	A	A	A			
Ethane	C ₂ H ₆	A	B	B	A	A	A	A	A	A	A	A	A	A	A	A	D	A	A	A	B	A	A	A	A	A			

Ratings: A - Excellent B - Good C - Poor D - Do not use Blank - No information

Media	Chemical Formula	Metals											Elastomers					Polymers									
		Aluminum	Brass	Carbon Steel	Ductile Iron / Cast Iron	316/316Ti/321 SS	17-4PH	Alloy 20	Monel	Hastelloy C	Inconel 625	Titanium	Bronze	304 Stainless Steel	Duplex	Buna N (Nitrile)	EPDM/EPR	Viton	Flexible Graphite	Delrin	Peek	PVDF	Teflon and Reinforced Teflon	PCTFE	UHMWPE	Vespele	PFA
Ethers	H ₂ O	B	A	B	B	A	A	A	A	A	A	A	A	A	D	C	C	C	A	C	A	C	A	A	A	A	C
Ethyl Acetate	C ₄ H ₈ O ₂	B	B	B	B	B	A	A	B	B	A	B	A	A	D	C	D	A	A	A	A	B	A	A	A	A	B
Ethyl Acrylate	C ₈ H ₁₀ O ₂	B	B	A	B	A	A	A	A	A	A	A	A	A	D	C	D	A	A	B	A	A	A	A	A	A	A
Ethyl Benzene	C ₈ H ₁₀	A	A	A	B	B	A	A	A	A	A	A	A	A	D	C	D	A	A	A	A	A	A	A	A	A	A
Ethyl Bromide	C ₂ H ₅ Br	B	A	A	B	B	A	A	A	A	A	A	A	A	D	C	D	A	A	A	A	A	A	A	A	A	A
Ethyl Chloride (dry)	C ₂ H ₅ Cl	B	B	B	B	A	A	A	A	A	A	A	A	A	D	C	D	A	A	A	A	A	A	A	A	A	B
Ethyl Chloride (wet)	C ₂ H ₅ Cl	D	C	C	D	B	B	B	B	C	C	C	C	C	D	D	D	A	A	B	A	B	A	A	A	A	B
Ethylene Chloride	C ₂ H ₄ Cl ₂	B	B	C	C	A	A	A	A	A	A	A	A	A	D	D	D	A	A	B	A	B	A	A	A	A	B
Ethylene Dichloride	C ₂ H ₄ Cl ₂	B	B	A	A	A	A	A	A	A	A	A	A	A	D	D	D	A	A	C	A	B	A	A	A	A	B
Ethylene Glycol	C ₂ H ₆ O ₂	A	B	B	B	A	A	A	A	A	A	A	A	A	D	C	D	A	A	A	A	A	A	A	A	A	A
Ethylene Oxide	C ₂ H ₄ O	D	D	B	C	B	B	A	A	B	B	B	B	B	D	D	D	A	A	C	A	A	A	A	A	A	A
Ethyl Ether	C ₄ H ₁₀ O	B	B	A	B	A	A	A	A	B	A	B	B	B	D	D	D	A	A	B	A	B	A	A	A	A	B
Ethyl Silicate	C ₈ H ₂₀ O ₄ Si	B	B	B	B	A	A	A	A	B	A	B	B	B	D	D	D	A	A	A	A	A	A	A	A	A	B
Ethyl Sulfate	C ₄ H ₁₀ O ₄ S	A	C	D	D	B	B	A	A	A	A	A	A	A	D	D	D	A	A	A	A	A	A	A	A	A	A
Fatty Acids	R-COOH	C	C	D	D	B	B	A	A	A	A	A	A	A	D	D	D	A	A	A	A	A	A	A	A	A	A
Ferric Hydroxide	Fe(OH) ₃	C	C	D	D	B	B	A	A	A	A	A	A	A	D	D	D	A	A	A	A	A	A	A	A	A	A
Ferric Nitrate	Fe(NO ₃) ₃	D	D	D	D	B	B	A	A	A	A	A	A	A	D	D	D	A	A	A	A	A	A	A	A	A	A
Ferric Sulfate	Fe ₂ (SO ₄) ₃	D	C	D	D	B	B	A	A	A	A	A	A	A	D	D	D	A	A	A	A	A	A	A	A	A	A
Ferrous Ammonium Citrate	C ₆ H ₅ (+4y)Fe(x)N(y)O ₇	B	B	B	B	A	A	A	A	B	B	B	B	B	D	D	D	A	A	A	A	A	A	A	A	A	A
Ferrous Chloride	Cl ₂ Fe	D	D	D	D	B	B	A	A	A	A	A	A	A	D	D	D	A	A	A	A	A	A	A	A	A	C
Ferrous Sulfate	FeH ₂ O ₄ S	C	C	D	D	B	B	A	A	A	A	A	A	A	D	D	D	A	A	A	A	A	A	A	A	A	A
Ferrous Sulfate (Saturated)	-	C	C	C	C	A	A	A	A	B	B	B	B	B	D	D	D	A	A	A	A	A	A	A	A	A	A
Fertilizer Solutions	-	D	C	A	A	A	A	A	A	B	B	B	B	B	D	D	D	A	A	A	A	A	A	A	A	A	A
Fish Oils	-	B	B	A	A	A	A	A	A	A	A	A	A	A	D	D	D	A	A	A	A	A	A	A	A	A	A
Flue Gases	CO	C	B	A	B	A	A	A	A	A	A	A	A	A	D	D	D	A	A	A	A	A	A	A	A	A	A
Fluoboric Acid	BF ₃ H	C	C	C	C	B	B	A	A	A	A	A	A	A	D	D	D	A	A	A	A	A	A	A	A	A	B
Fluorosilicic Acid	FeH ₂ Si	D	B	D	D	B	B	A	A	A	A	A	A	A	D	D	D	A	A	A	A	A	A	A	A	A	C
Formaldehyde (cold)	CH ₄	B	B	B	B	A	A	A	A	A	A	A	A	A	D	D	D	A	A	A	A	A	A	A	A	A	A
Formaldehyde (hot)	CH ₄	B	B	C	D	C	B	B	B	B	B	B	B	B	D	D	D	A	A	A	A	A	A	A	A	A	A
Formic Acid (cold)	CH ₂ O ₂	B	D	D	D	B	B	A	A	A	A	A	A	A	D	D	D	A	A	A	A	A	A	A	A	A	B
Formic Acid (hot)	CH ₂ O ₂	B	D	D	D	B	B	A	A	A	A	A	A	A	D	D	D	A	A	A	A	A	A	A	A	A	A

Ratings: A - Excellent B - Good C - Poor D - Do not use Blank - No information

Media	Chemical Formula	Metals											Elastomers					Polymers										
		Aluminum	Brass	Carbon Steel	Ductile Iron / Cast Iron	316/316Ti/321 S5t	17-4PH	Alloy 20	Monel	Hastelloy C ^o	Inconel 625	Titanium	Bronze	304 Stainless Steel	Duplex	Buna N (Nitrile)	EPDM/EPR	Viton	Flexible Graphite	Delrin [®]	Peek [®]	PVDF	Teflon [®] and Reinforced	PCTFE	UHMWPE [®]	VespeI [®]	PFA	KEL-F [®]
Freon Gas (dry)	-	B	A	B	B	A	A	A	A	A	A	A	A	A	C	C	C	C	A	A	A	A	A	A	A	A	A	A
Freon 11, MF, 112, BF	CCl3F	D	A	B	C	A	A	A	A	A	A	A	A	A	C	C	C	C	A	D	D	A	A	A	A	A	A	A
Freon 12, 32, 114, 115	CCl2F2	B	A	B	B	A	A	A	A	A	A	A	A	A	B	B	B	B	A	B	A	C	A	A	A	A	A	C
Freon 21, 31	CHCl2F	B	A	B	C	A	A	A	A	A	A	A	A	A	D	D	D	D	A	A	A	A	A	A	A	A	A	A
Freon 22	CHClF2	D	A	B	C	A	A	A	A	A	A	A	A	A	D	D	D	D	A	A	A	A	A	A	A	A	A	A
Freon 113, TF	C2Cl3F3	D	A	B	C	A	A	A	A	A	A	A	A	A	B	D	D	D	A	A	A	B	A	A	A	A	A	A
Freon (wet)	-	D	B	D	D	C	B	B	B	B	B	B	B	B	B	B	B	B	A	B	A	A	A	A	A	A	A	A
Fruit Juices	-	B	D	D	D	A	A	A	A	A	A	A	A	A	A	A	A	A	A	C	A	A	D	A	A	A	A	A
Fuel Oil	-	B	B	A	B	A	A	A	A	A	A	A	A	A	A	A	A	A	A	A	A	A	A	A	A	A	A	A
Fumaric Acid	C4H4O4																											
Furfural	C5H4O2	A	A	A	B	A	A	A	A	A	A	A	A	A	A	A	A	A	A	A	A	D	A	A	A	A	A	D
Galic Acid 5%	C7H6O5	B	C	D	D	B	B	B	B	B	B	B	B	B	B	C	C	C	A	B	A	B	A	A	A	A	A	A
Gas, Manufactured	-	C	B	B	B	B	B	B	B	B	B	B	B	B	A	A	A	A	A	A	A	A	A	A	A	A	A	A
Gas, Natural	-	B	B	B	B	B	B	B	B	B	B	B	B	B	A	A	A	A	A	A	A	A	A	A	A	A	A	A
Gas, Odorizers	-	A	A	B	B	B	B	B	B	B	B	B	B	B	A	A	A	A	A	A	A	A	A	A	A	A	A	A
Gasoline (aviation)	-	A	A	A	B	A	A	A	A	A	A	A	A	A	A	A	A	A	A	A	A	A	A	A	A	A	A	A
Gasoline (leaded)	-	A	A	A	A	A	A	A	A	A	A	A	A	A	A	A	A	A	A	A	A	B	A	A	A	A	A	A
Gasoline (motor)	-	A	A	A	B	A	A	A	A	A	A	A	A	A	A	A	A	A	A	A	A	A	A	A	A	A	A	A
Gasoline (refined)	C12H13N5O6S2	A	B	B	B	B	B	B	B	B	B	B	B	B	A	A	A	A	A	A	A	A	A	A	A	A	A	A
Gasoline (sour)	-	A	B	B	B	B	B	B	B	B	B	B	B	B	A	A	A	A	A	A	A	A	A	A	A	A	A	A
Gasoline (unleaded)	-	A	A	B	B	A	A	A	A	A	A	A	A	A	A	A	A	A	A	A	A	A	A	A	A	A	A	A
Gelatine	-	A	C	D	D	A	A	A	A	A	A	A	A	A	A	A	A	A	A	A	A	B	A	A	A	A	A	A
Glucose	C6H12O6	A	A	B	B	A	A	A	A	A	A	A	A	A	A	A	A	A	A	A	A	A	A	A	A	A	A	A
Glue	-	A	A	A	B	B	A	A	A	A	A	A	A	A	A	A	A	A	A	A	A	A	A	A	A	A	A	A
Glycerine (Glycerol)	C3H8O3	A	B	B	B	B	A	A	A	A	A	A	A	A	A	A	A	A	A	A	A	A	A	A	A	A	A	A
Glycol Amine	-	C	D	A	B	B	A	A	A	A	A	A	A	A	A	D	C	A	C	A	A	A	A	A	A	A	A	A
Glycol	C2H6O2	B	B	B	B	B	A	A	A	A	A	A	A	A	A	B	A	A	C	A	A	A	A	A	A	A	A	A
Graphite	CH4	B	B	C	B	B	A	A	A	A	A	A	A	A	A	B	B	B	A	A	A	A	A	A	A	A	A	A
Grease	-	B	B	A	A	A	A	A	A	A	A	A	A	A	A	A	A	A	A	A	A	A	A	A	A	A	A	A
Helium Gas	He	B	B	B	A	B	A	A	A	A	A	A	A	A	A	B	B	B	A	A	A	A	A	A	A	A	A	A
Heptane	C7H16	A	A	A	A	A	A	A	A	A	A	A	A	A	A	A	A	A	A	A	A	A	A	A	A	A	A	A

Ratings: A - Excellent B - Good C - Poor D - Do not use Blank - No information

Media	Chemical Formula	Metals											Elastomers					Polymers											
		Aluminum	Brass	Carbon Steel	Ductile Iron / Cast Iron	316/316Ti/321 SS	17-4PH	Alloy 20	Monel	Hastelloy C	Inconel 625	Titanium	Bronze	304 Stainless Steel	Duplex	Buna N (Nitrile)	EPDM/EPR	Viton	Flexible Graphite	Delrin	Peek	PVDF	Teflon and Reinforced	Teflon	PCTFE	UHMWPE	Vespele	PFA	KEL-F
Hexane	C ₆ H ₁₄	A	A	A	A	A	A	A	A	A	A	A	A	A	A	A	A	A	A	A	A	A	A	A	A	A	A	A	A
Hexanol, Tertiary		A	A	A	A	A	A	A	A	A	A	A	A	A	A	A	A	A	A	A	A	A	A	A	A	A	A	A	A
Hydraulic Oil Petr. Base	-	A	B	A	A	A	A	A	A	A	A	A	A	A	A	A	A	A	A	A	A	A	A	A	A	A	A	A	A
Hydrazine	H ₄ N ₂	C	D	C	D	B	A	A	B	A	A	C	A	A	C	B	C	A	A	B	D	A	A	A	A	A	D	A	A
Hydrocyanic Acid	HCN	C	D	D	C	A	B	A	A	A	B	D	C	B	B	B	A	A	A	C	D	A	A	A	A	A	A	A	A
Hydrofluoric Acid 20%	HF	D	D	D	D	D	C	B	A	B	D	C	D	D	D	D	A	A	A	D	D	B	B	A	A	C			B
Hydrofluoric Acid 50%	HF	D	D	D	D	D	D	C	B	C	D	D	C	D	D	D	D	B	A	D	D	B	B	A	A	C			B
Hydrofluoric Acid 75%	HF	D	D	D	D	D	D	C	B	C	D	D	C	D	D	D	D	B	A	D	D	B	B	A	A	C			B
Hydrofluoric Acid 100%	HF	D	D	D	D	D	D	D	D	D	D	D	C	D	D	D	D	B	A	D	D	B	B	A	A	C			A
Hydrofluosilicic Acid	H ₂ SiF ₆	D	B	D	D	C	B	B	C	D	D	B	C	D	D	D	B	B	A	B	B	B	A	A	A				B
Hydrogen Gas (cold)	H	A	A	A	A	A	A	A	A	A	A	A	A	A	A	A	A	A	A	A	A	A	A	A	A	A	A	A	B
Hydrogen Gas (hot)	H	C		B		B		A		A							B	B											B
Hydrogen Peroxide Conc.	H ₂ O ₂	C	D	D	D	B	A	A	C	B	A	B	D	B	D	C	B	C	B	C	D	A	B	A	A	A	A	A	B
Hydrogen Peroxide, Dilute	H ₂ O ₂	C	D	D	D	B	A	A	B	A	A	B	D	B	D	C	B	C	B	C	D	A	B	A	A	A	A	A	B
Hydrogen Sulfide (dry)	H ₂ S	C	C	C	C	C	B	B	B	B	A	D	C	C	C	C	C	A	D	A	C	A	B	A	A	A	A	A	B
Hydrogen Sulfide (wet)	H ₂ S	C	C	C	C	C	C	B	C	B	B	D	C	C	C	C	C	B	D	A	C	A	B	A	A	A	A	A	B
Hypo (Sodium Thiosulfate)	Na ₂ S ₂ O ₃	B	C	D	D	B	A	B	B			B	B																A
Illuminating Gas	-	A	A	A	A	A	A	A	A	A	A	A	A	A	A	A	A	A	A	A	A	A	A	A	A	A	A	A	A
Ink-Newsprint	C ₁₁ H ₁₆ O ₃ P+	C	C	D	D	A	A	B	A	B	A	B	C																
Iodoform	CHI ₃	C	C	B	C	A	A	A	C	B	A	B	C																
Iso-Butane	C ₄ H ₁₀	A	A	A	A	A	A	A	A	A	A	A	A	A	A	A	A	A	A	A	A	A	A	A	A	A	A	A	
Iso-Octane	C ₈ H ₁₈	A	A	A	A	A	A	A	A	A	A	A	A	A	A	A	A	A	A	A	A	A	A	A	A	A	A	A	
Isopropyl Acetate	C ₅ H ₁₀ O ₂	B		B	C	B	A	A	A	A	A	B	B																B
Isopropyl Ether	C ₆ H ₁₄ O	A	A	A	A	B	A	A	A	A	A	A	A	A	A	A	A	A	A	A	A	A	A	A	A	A	A	A	A
JP-4 Fuel	-	A	A	A	A	A	A	A	A	A	A	A	A	A	A	A	A	A	A	A	A	A	A	A	A	A	A	A	A
JP-5 Fuel	-	A	A	A	A	A	A	A	A	A	A	A	A	A	A	A	A	A	A	A	A	A	A	A	A	A	A	A	A
JP-6 Fuel	-	A	A	A	A	A	A	A	A	A	A	A	A	A	A	A	A	A	A	A	A	A	A	A	A	A	A	A	A
Kerosene	-	B	A	A	B	A	A	A	A	A	A	A	A	A	A	A	A	A	A	A	A	A	A	A	A	A	A	A	A
Ketchup	-	C		C	C	A	A	A	A	A	A																		
Ketones	CH ₂ O	B	A	A	A	A	A	A	A	A	A	A	A	A	A	A	A	A	A	A	A	A	A	A	A	A	A	A	C
Laquer (and Solvent)	-	A	C	D	C	B	B	A	A	A	A	B	A	B	D	D	D	D	D	D	D	D	D	D	D	D	D	D	A

Ratings: A - Excellent B - Good C - Poor D - Do not use Blank - No information

Media	Chemical Formula	Metals										Elastomers				Polymers												
		Aluminum	Brass	Carbon Steel	Ductile Iron / Cast Iron	316/316Ti/321 SS	17-4PH	Alloy 20	Monel	Hastelloy C ^o	Inconel 625	Titanium	Bronze	304 Stainless Steel	Duplex	Buna N (Nitrile)	EPDM/EPR	Viton	Flexible Graphite	Delrin ^o	Peek ^o	PVDF	Teflon ^o and Reinforced	Teflon	PCTFE	UHMWPE ^o	Vespele ^o	PFA
Lactic Acid Concentrated (cold)	C ₃ H ₆ O ₃	C	D	D	D	D	A	A	A	A	A	A	B	A	B	B	A	A	A	C	A	B	A	A	A	A	A	B
Lactic Acid Concentrated (hot)	C ₃ H ₆ O ₃	C	D	D	D	D	B	B	B	B	A	D	B	B	C	C	B	A	A	C	A	C	A	A	A	A	A	
Lactic Acid Dilute (cold)	C ₃ H ₆ O ₃	B	D	D	D	A	A	A	A	A	A	C	A	A	A	A	A	A	A	A	B	A	B	A	A	A	A	B
Lactic Acid Dilute (hot)	C ₃ H ₆ O ₃	B	D	D	D	A	A	A	A	A	A	C	A	A	A	A	A	A	A	B	A	B	A	A	A	A	A	
Lactose	C ₁₂ H ₂₂ O ₁₁	B	B	C	C	B	B	B	B	B	B	C	B	B	B	B	B	B	B	A	A	A	A	A	A	A	A	
Lard	-	A	B	A	A	A	A	A	A	A	A	A	A	A	A	A	A	A	A	A	A	A	A	A	A	A	A	
Lard Oil	-	B	B	C	C	B	B	B	B	B	B	C	A	A	A	A	A	A	A	A	A	A	A	A	A	A	A	
Lead Acetate	C ₄ H ₆ O ₄ Pb	D	C	C	D	B	B	B	B	B	A	C	B	A	A	A	D	A	A	B	A	A	A	A	A	A	A	A
Lead Sulfate	O ₄ PbS	D	C	C	D	B	B	B	B	B	B	B	C	B	B	B	B	B	B	A	A	A	A	A	A	A	A	A
Lecithin	C ₄₆ H ₈₈ NO ₈ P+	B	C	C	C	B	B	B	B	B	B	A	A	A	A	A	D	D	B	A	A	A	A	A	A	A	A	
Linoleic Acid	C ₁₈ H ₃₂ O ₂	B	C	C	B	B	B	B	B	B	A	C	B	B	B	B	D	B	A	B	A	A	A	A	A	A	A	
Linseed Oil	-	A	A	A	A	A	A	A	A	A	A	A	A	A	A	A	D	A	A	A	A	A	A	A	A	A	A	
Lithium Chloride	CLi	C	B	C	B	B	A	A	A	A	A	B	A	B	A	B	B	A	A	A	A	A	A	A	A	A	A	
Liquid Petroleum Gas (LPG)	C ₃ H ₇ NO ₂	A	A	A	A	B	B	B	B	B	B	A	A	A	A	A	D	A	A	A	A	A	A	A	A	A	A	
Lubricating Oil Petroleum Base	C ₆ H ₆	A	A	A	A	A	A	A	A	A	A	A	A	A	A	A	D	A	A	A	A	A	A	A	A	A	A	
Ludox	O ₂ Si	C	D	A	B	B	A	A	A	A	A	C	C	C	C	B	B	B	B	B	B	B	B	B	B	B	B	
Magnesium Bisulfate	HMG ₄ S+	D	B	B	B	B	A	A	A	A	A	A	A	A	A	B	B	B	B	A	A	A	A	A	A	A	A	
Magnesium Bisulfate	-	C	D	B	B	D	B	B	B	B	B	B	B	B	B	B	B	B	B	A	A	A	A	A	A	A	A	
Magnesium Carbonate	CMgO ₃	A	B	B	B	A	A	A	A	A	A	A	B	B	B	B	B	B	B	A	A	A	A	A	A	A	A	
Magnesium Chloride	Cl ₂ Mg	D	C	C	D	C	D	C	D	C	D	A	B	B	B	A	A	A	A	A	A	A	A	A	A	A	A	A
Magnesium Hydroxide	H ₂ MgO ₂	D	B	B	B	A	A	A	A	A	A	B	B	B	B	A	A	A	A	A	A	A	A	A	A	A	A	A
Magnesium Hydroxide (hot)	H ₂ MgO ₂	D	C	B	B	A	A	A	A	A	A	B	B	B	B	A	A	A	A	A	A	A	A	A	A	A	A	A
Magnesium Nitrate	MgN ₂ O ₆	B	C	B	B	A	A	A	A	A	A	C	C	C	B	B	B	B	B	A	A	A	A	A	A	A	A	
Magnesium Sulfate	MgO ₄ S	B	B	B	B	A	A	A	A	A	A	A	A	A	A	A	A	A	A	A	A	A	A	A	A	A	A	A
Maleic Acid	C ₄ H ₄ O ₄	B	B	C	C	B	B	A	A	A	A	A	B	B	B	B	D	A	A	A	A	A	A	A	A	A	A	A
Maleic Anhydride	C ₄ H ₂ O ₃	B	B	B	B	A	A	A	A	A	A	A	A	A	A	D	D	B	B	D	A	A	A	A	A	A	A	
Malic Acid	C ₄ H ₆ O ₅	B	B	D	D	A	A	A	A	A	A	C	A	A	A	A	D	A	B	A	A	A	A	A	A	A	A	
Malt Beverages	-	B	B			A																						
Manganese Carbonate	-	B	B			B																						
Manganese Sulfate	MnO ₄ S	B	D	B	D	A	B	A	A	A	A	A	A	A	A	B	B	B	A	B	A	A	A	A	A	A	A	B
Mayonnaise	-	D	D	D	D	A	B	A	A	A	A	D	B	B	A	A	A	A	A	A	A	A	A	A	A	A	A	

Ratings: A - Excellent B - Good C - Poor D - Do not use Blank - No information

10.23 Chemical Compatibility Table

Media	Chemical Formula	Metals										Elastomers					Polymers											
		Aluminum	Brass	Carbon Steel	Ductile Iron / Cast Iron	316/316Ti/321 SS	17-4PH	Alloy 20	Monel	Hastelloy C ^o	Inconel 625	Titanium	Bronze	304 Stainless Steel	Duplex	Buna N (Nitrile)	EPDM/EPR	Viton	Flexible Graphite	Delrin ^o	Peek ^o	PVDF	Teflon ^o and Reinforced	Teflon	PCTFE	UHMWPE ^o	Vespele ^o	PFA
Meat Juices	-	B	D			A	A								B	B	A	A	A	A	A	A	A	A	A	A	A	A
Melamine Resins	C ₃ H ₆ N ₆		D		D	C	C	A							C	B	A	A	C	A	A	A	A	A	A			A
Methanol	CH ₄ O	A	A	A	A	A	A	A		B	A				A	B	A	B	A	A	A	A	A	A	A	A		
Mercuric Chloride	Cl ₂ Hg	D	D	D	D	D	C	D	B	A	D	D			A	A	A	C	B	A	A	A	A	A	A	A	A	B
Mercuric Cyanide	C ₂ HgN ₂	D	D	D	D	C	A	D	A	A	D	C			A	D	A	A	A	A	A	A	A	A	A	A	A	D
Mercurous Nitrate	HgNO ₃	D	D	D	D	A	A	D	A	A	D	A			B	B	A	B	A	A	A	A	A	A	A	A	A	A
Mercury	Hg	C	D	A	A	A	A	A	A	A	B	A			A	A	A	C	A	A	A	A	A	A	A	A	A	A
Methane	CH ₄	A	A	A	A	A	A	A	A	A	A	A			A	A	A	B	A	A	A	A	A	A	A	A	A	A
Methyl Acetate	C ₃ H ₆ O ₂	A	A	A	A	A	A	A	A	A	A	A			A	D	A	A	B	A	A	A	A	A	A	A	A	A
Methyl Acetone	C ₄ H ₈ O	A	A	A	A	A	A	A	A	A	A	A			D	B	D	A	B	A	A	A	A	A	A	A	A	A
Methyl Amine	CH ₅ N	B	C	B	B	A	A	C	B		D	A			D	B	D	D	A	A	A	A	A	A	A	A	A	A
Methyl Bromide 100%	CH ₃ Br	C	C	C	D	B	B	B	B		D	B			B	D	A	A	D	B	A	A	A	A	A	A	A	A
Methyl Cellosolve	C ₃ H ₈ O ₂	B	A	B	B	A	A	A	A		A	B			C	B	D	A	D	A	A	A	A	A	A	A	A	A
Methyl Cellulose	-																											
Methyl Chloride	CH ₃ Cl	D	C	A	B	A	A	A	A	A	A	B	A		D	D	B	A	C	C	A	A	A	A	A	A	A	B
Methyl Ethyl Ketone	C ₄ H ₈ O	B	A	A	A	A	A	A	A	A	A	A			D	B	D	A	B	B	A	A	A	A	A	A	A	B
Methylene Chloride	CH ₂ Cl ₂	C	B	B	B	A	A	A	A	A	B	B	A		D	D	C	A	B	A	C	A	A	A	A	A	A	A
Methyl Formate	C ₂ H ₄ O ₂	B		C	B	A	A	A	A	A	A	A			D	B	D	C	A	B	A	A	A	A	A	A	A	A
Methyl Isobutyle Ketone	C ₆ H ₁₂ O	B		C	B	A	A	A	A	A	A	A			D	C	D	A	C	B	D	A	A	A	A	A	A	A
Milk & Milk Products	-	C	C	C	D	A	A	A	A	A	A	A			A	A	A	A	A	A	A	A	A	A	A	A	A	A
Mineral Oils	-	A	A	A	B	A	A	A	A	A	A	A			A	D	A	A	A	A	A	A	A	A	A	A	A	A
Mineral Spirits	-	A	B	B	B	A	B	B	B	B	B	B			A	D	A	A	A	A	A	A	A	A	A	A	A	A
Mixed Acids (cold)	-	D	D	C	C	B	B	C							D	D	B	B	D	D								A
Molasses, crude	-	B	B	A	A	A	A	A	A	A	A	A			A	B	A	A	A	A	A	C	A	A	A	A	A	A
Molasses, Edible	-	A	B	A	C	A	A	A	A	A	A	A			A	B	A	A	A	A	A	B	A	A	A	A	A	A
Molybdic Acid	H ₂ MoO ₄																											
Monochloro Benzene (dry)	C ₆ H ₅ Cl	B	B	B	A	A	A	A	A	A	A	B			D	D	B	A	C	B	A	A	A	A	A	A	A	A
Morphine	C ₁₇ H ₁₉ NO ₃	B	B	B	B	A									D	B	D	D	A	C	B	A	A	A	A	A	A	A
Mustard	C ₄ H ₈ Cl ₂ S	B	A	B	B	A									A	A	A	A	A	C	A	A	A	A	A	A	A	A
Naptha	-	A	A	A	B	A	A	A	A	A	A	A			B	D	A	A	A	B	A	A	A	A	A	A	A	A
Napthalene	C ₁₀ H ₈	A	B	A	B	A	A	A	A	A	A	A			D	D	A	A	A	B	A	A	A	A	A	A	A	A

Ratings: A - Excellent B - Good C - Poor D - Do not use Blank - No information

Media	Chemical Formula	Metals										Elastomers					Polymers											
		Aluminum	Brass	Carbon Steel	Ductile Iron / Cast Iron	316/316Ti/321 SSt	17-4PH	Alloy 20	Monel	Hastelloy C [®]	Inconel 625	Titanium	Bronze	304 Stainless Steel	Duplex	Buna N (Nitrile)	EPDM/EPR	Viton	Flexible Graphite	Delrin [®]	Peek [®]	PVDF	Teflon [®] and Reinforced	PCTFE	UHMWPE [®]	VespeI [®]	PFA	KEL-F [®]
Natural Gas, Sour	-	B	A	A	B	A	A	A	B	A	A	A	A	A	A	A	D	A	A	B	A	A	A	A	A	A	A	
Nickel Ammonium Sulfate	H ₁₈ N ₂ NI ₀ S ₂	D	D	D	D	A	A	C																				
Nickel Chloride	Cl ₂ NI	D	D	D	D	B	B	A	C	A	A	D	D															A
Nickel Nitrate	N ₂ NI ₀ 6	D	D	D	D	B	A	A	C	B	B	C	B															A
Nickel Sulfate	NI ₀ 4S	D	D	D	D	B	B	A	B	C	B	C	B															A
Nicotinic Acid	C ₆ H ₅ NO ₂	A	A	C	C	A	A	A	B																			A
Nitric Acid 10%	HNO ₃	C	D	D	D	B	A	A	D	B	A	A	A															B
Nitric Acid 30%	HNO ₃	D	D	D	D	B	B	A	D	A	A	D	A															A
Nitric Acid 80%	HNO ₃	D	D	D	D	B	C	A	D	B	B	D	A															A
Nitric Acid 100%	HNO ₃	B	D	D	D	B	C	A	D	B	B	D	A															A
Nitric Acid Anhydrous	-	B	D	D	C	B	D	A	D																			A
Nitrobenzene	C ₆ H ₅ NO ₂	B	D	A	A	B	A	A	B	B	A	B	B															A
Nitrogen	N ₂	A	A	A	A	A	A	A	A	A	A	A	A															A
Nitrous Acid 10%	HNO ₂	D	D	D	D	B	B	D	C																			B
Nitrous Gases	-	B	D	B	C	A	A	A	D																			A
Nitrous Oxide	N ₂ O	B	B	B	C	B	B	D	B																			A
Oils&Fats	-	B																										A
Oils&Animal	-	A	A	A	A	A	A	A	B	A																		A
Oils, Petroleum (refined)	C ₆ H ₆	A	B	A	B	A	A	A	A	A	A	A	A															A
Oils, Petroleum (sour)	C ₆ H ₆	A	C	B	C	A	A	A	A	A	A	A	A															A
Oils, Water Mixture	-	A	A	B	B	A	A	A	A																			A
Olaic Acid	-	B				B	B	A	A																			A
Oleic Acid	C ₁₈ H ₃₄ O ₂	B	D	C	C	B	A	A	B	B	B	C	A															B
Oleum	H ₂ O ₄ S	C	C	B	D	B	B	C	B																			A
Oleum Spirits	-	D	D		D	B																						A
Olive Oil	-	A	B	B	A	A	A	A	A	A	A	A	A															A
Oxalic Acid	C ₂ H ₂ O ₄	C	C	C	D	B	B	B	B	B	A	C	B															A
Oxygen	O ₂	A	A	A	A	A	A	A	A	A	A	A	A															A
Ozone (dry)	O ₃	A	A	A	A	A	A	A	A	A	A	A	A															A
Ozone (wet)	O ₃	B	B	B	C	A																						A
Paints & Solvents	-	A	A	A	A	A	A	A	A	A	A	A	A															A

Ratings: A - Excellent B - Good C - Poor D - Do not use Blank - No information

10.25 Chemical Compatibility Table

Media	Chemical Formula	Metals										Elastomers					Polymers										
		Aluminum	Brass	Carbon Steel	Ductile Iron / Cast Iron	316/316Ti/321 SS	17-4PH	Alloy 20	Monel	Hastelloy C	Inconel 625	Titanium	Bronze	304 Stainless Steel	Duplex	Buna N (Nitrile)	EPDM/EPR	Viton	Flexible Graphite	Delrin	Peek	PVDF	Teflon and Reinforced Teflon	PCTFE	UHMWPE	Vespel	PFA
Palmitic Acid	C ₁₆ H ₃₂ O ₂	B	C	C	C	B	A	A	A	A	A	A	A	A	B	B	A	A	A	A	A	B	A	A	A	A	
Palm Oil	-	A	B	C	C	B	A	A	A	A	A	A	A	A	B	D	A	A	A	D	A	A	A	A	A		
Paper Pulp	-	C	B	B	B	A	A	B																			
Paraffin	C _n H _{2n+2}	A	A	B	B	A	A	A	A	A	A	A	A	A	A	D	A	A	A	A	A	A	A	A	A	A	A
Paraformaldehyde	CH ₂ O	B	B	B	B	B	B	B	B	B	B	B	B	B	B	C	C										
Paraldehyde	C ₆ H ₁₂ O ₃																										
Pentane	C ₅ H ₁₂	A	A	B	B	A	A	A	A	A	A	A	A	A	B	D	A	A	A	B	A	A	A	A	A	A	A
Perchloroethylene (dry)	C ₂ Cl ₄	B	C	B	B	A	A	A	A	A	A	A	A	A	B	D	A	A	A	B	A	A	A	A	A	A	A
Petrolatum (Vaseline Petr. Jelly)	-	B	B	C	C	B	A	A	A	A	A	A	A	A	A	A	A	A	A	B	A	A	A	A	A	A	A
Phenol	C ₆ H ₆ O	A	D	C	D	A	A	A	A	A	A	A	A	A	B	D	B	A	C	D	B	A	A	A	A	A	B
Phosphate Ester 10%	-	C	D	A	C	A	A	A	A	A	A	A	A	A	C	D	A										
Phosphate Acid 10%	-	C	D	D	D	C	B	B	D																		
Phosphoric Acid 50% (cold)	H ₃ O ₄ P	D	D	D	D	C	B	B	D	B	D	B	D	D	D	D	B	A	A	D	A	B	A	A	A	A	A
Phosphoric Acid 50% (hot)	H ₃ O ₄ P	D	D	D	D	C	B	D	B	C	D	D	D	D	D	D	B	A	A	D	A	B	A	A	A	A	A
Phosphoric Acid 85% (cold)	H ₃ O ₄ P	D	D	D	D	C	B	D	B	B	D	B	D	D	D	D	B	A	A	D	A	B	A	A	A	A	A
Phosphoric Acid 85% (hot)	H ₃ O ₄ P	D	D	D	D	C	B	D	B	C	D	D	D	D	D	D	B	A	A	D	B	B	A	A	A	A	A
Phosphoric Anhydride	P ₂ O ₅	C																									
Phosphorus Trichloride	PCl ₃	C																									
Phthalic Acid	C ₈ H ₆ O ₄	C	B	D	C	B	A	A	A	A	A	A	A	A	B	D	B	A	C	D	B	A	B	A	A	A	A
Phthalic Anhydride	C ₈ H ₄ O ₃	B	B	D	C	B	A	A	A	A	A	A	A	A	B	D	B	A	C	D	B	A	A	A	A	A	A
Picric Acid	C ₆ H ₃ N ₃ O ₇	C	D	D	D	B	B	D	B	A	C	B	B	B	B	D	B	A	A	C	A	B	A	A	A	A	A
Pineapple Juice	-	A	C	C	C	A	A	A	A	A	A	A	A	A	A	A	A	A	A	A	A	A	A	A	A	A	A
Pine Oil	-	B	B	B	B	A	A	A	A	A	A	A	A	A	C	A	D	A	D	A	D	A	A	A	A	A	
Pitch (Bitumen)	C ₆ H ₆																										
Polysulfide	-	C	D																								
Polyvinyl Acetate	C ₆ H ₁₂ O ₂	B	B	C	B	B	B	B	B	A	B	B	B	B	A												
Polyvinyl Chloride	C ₂ H ₃ Cl	B	D																								
Potassium Bicarbonate	CHK ₃ O ₃	C																									
Potassium Bichromate	Cr ₂ K ₂ O ₇	B	B	B	A	A	A	A	A	A	A	A	A	A	B	B	A	A	A	B	A	B	A	A	A	A	A
Potassium Bisulfate	HKO ₄ S	B																									
Potassium Bisulfite	HKO ₄ S	C	C	D	D	B	B	D																			

Ratings: A - Excellent B - Good C - Poor D - Do not use Blank - No information

Media	Chemical Formula	Metals										Elastomers					Polymers													
		Aluminum	Brass	Carbon Steel	Ductile Iron / Cast Iron	316/316Ti/321 SSt	17-4PH	Alloy 20	Monel	Hastelloy C ^o	Inconel 625	Titanium	Bronze	304 Stainless Steel	Duplex	Buna N (Nitrile)	EPDM/EPR	Viton	Flexible Graphite	Delrin [®]	Peek [®]	PVDF	Teflon [®] and Reinforced	Teflon	PCTFE	UHMWPE [®]	Vespel [®]	PFA	KEL-F [®]	
Potassium Bromide	BrK	C	C	C	D	B	B	B	B	B	B	B	B	B	B	B	B	B	B	B	B	B	A	A	A	A	A	A	A	
Potassium Carbonate	K ₂ O ₃	C	B	B	B	A	A	A	A	A	A	A	A	A	A	A	A	A	A	A	A	A	A	A	A	A	A	A	A	
Potassium Chlorate	KClO ₃	B	B	B	B	A	A	A	A	A	A	A	A	A	A	A	A	A	A	A	A	A	A	A	A	A	A	A	A	
Potassium Chloride	KCl	D	C	C	B	B	B	B	B	B	B	B	B	B	B	B	B	B	B	B	B	B	B	B	B	B	B	B	B	
Potassium Chromate	K ₂ O ₄	B	B	B	B	B	B	B	B	B	B	B	B	B	B	B	B	B	B	B	B	B	B	B	B	B	B	B	B	
Potassium Cyanide	KCN	D	D	B	B	B	B	B	B	B	B	B	B	B	B	B	B	B	B	B	B	B	B	B	B	B	B	B	B	
Potassium Dichromate	Cr ₂ K ₂ O ₇	B	D	C	C	B	B	B	B	B	B	B	B	B	B	B	B	B	B	B	B	B	B	B	B	B	B	B	B	
Potassium Ferricyanide	C ₆ FeK ₃ N ₆	C	D	C	C	A	A	A	A	A	A	A	A	A	A	A	A	A	A	A	A	A	A	A	A	A	A	A	A	
Potassium Ferrocyanide	C ₆ FeK ₄ N ₆ +4	C	C	C	C	B	B	B	B	B	B	B	B	B	B	B	B	B	B	B	B	B	B	B	B	B	B	B	B	
Potassium Hydroxide Dilute (cold)	HKO	D	D	B	D	B	B	B	B	B	B	B	B	B	B	B	B	B	B	B	B	B	B	B	B	B	B	B	B	
Potassium Hydroxide to 70% (cold)	HKO	D	D	C	D	B	B	B	B	B	B	B	B	B	B	B	B	B	B	B	B	B	B	B	B	B	B	B	B	
Potassium Hydroxide Dilute (hot)	HKO	D	D	B	D	B	B	B	B	B	B	B	B	B	B	B	B	B	B	B	B	B	B	B	B	B	B	B	B	
Potassium Hydroxide to 70% (hot)	HKO	D	D	C	D	B	B	B	B	B	B	B	B	B	B	B	B	B	B	B	B	B	B	B	B	B	B	B	B	
Potassium Iodide	IK	B	C	B	B	B	B	B	B	B	B	B	B	B	B	B	B	B	B	B	B	B	B	B	B	B	B	B	B	
Potassium Nitrate	KNO ₃	B	B	B	B	B	B	B	B	B	B	B	B	B	B	B	B	B	B	B	B	B	B	B	B	B	B	B	B	
Potassium Oxalate	C ₂ K ₂ O ₄	B																												
Potassium Permanganate	KMnO ₄	B	B	B	B	B	B	B	B	B	B	B	B	B	B	B	B	B	B	B	B	B	B	B	B	B	B	B	B	
Potassium Phosphate (mono)	KH ₂ PO ₄	D	C		C	B	A	B	B	B	B	B	B	B	B	B	B	B	B	B	B	B	B	B	B	B	B	B	B	
Potassium Phosphate Di-basic	K ₂ HPO ₄	B	B	A	A	A	A	A	A	A	A	A	A	A	A	A	A	A	A	A	A	A	A	A	A	A	A	A	A	A
Potassium Phosphate Tri-basic	K ₃ PO ₄	D																												
Potassium Sulfate	K ₂ O ₄ S	B	C	B	B	B	B	B	B	B	B	B	B	B	B	B	B	B	B	B	B	B	B	B	B	B	B	B	B	
Potassium Sulfide	Hk ₂ S+	C	D	D	C	A	B	B	D	B	A	D	B	A	A	A	A	A	A	A	A	A	A	A	A	A	A	A	A	
Potassium Sulfite	K ₂ O ₃ S	B	B	D	C	A	B	A	C	B	A	C	B	A	A	A	A	A	A	A	A	A	A	A	A	A	A	A	A	
Producer Gas	-	B	B	B	B	B	B	B	B	B	B	B	B	B	B	B	B	B	B	B	B	B	B	B	B	B	B	B	B	
Propane Gas	C ₃ H ₈	A	A	A	A	A	A	A	A	A	A	A	A	A	A	A	A	A	A	A	A	A	A	A	A	A	A	A	A	
Propyl Bromide	C ₃ H ₇ Br	B	B	B	B	B	B	B	B	B	B	B	B	B	B	B	B	B	B	B	B	B	B	B	B	B	B	B	B	
Propylene Glycol	C ₃ H ₈ O ₂	C	B	B	B	B	B	B	B	B	B	B	B	B	B	B	B	B	B	B	B	B	B	B	B	B	B	B	B	
Pyridine	C ₅ H ₅ N	B	B	B	B	B	B	B	B	B	B	B	B	B	B	B	B	B	B	B	B	B	B	B	B	B	B	B	B	
Pyrogallic Acid	-	B	B	B	B	B	B	B	B	B	B	B	B	B	B	B	B	B	B	B	B	B	B	B	B	B	B	B	B	
Quench Oil	-	A	B	B	B	A	A	A	A	A	A	A	A	A	A	A	A	A	A	A	A	A	A	A	A	A	A	A	A	
Quinine Sulfate (dry)	C ₄₀ H ₅₀ N ₄ O ₈ S																													

Ratings: A - Excellent B - Good C - Poor D - Do not use Blank - No information

Media	Chemical Formula	Metals											Elastomers					Polymers										
		Aluminum	Brass	Carbon Steel	Ductile Iron / Cast Iron	316/316Ti/321 SS	17-4PH	Alloy 20	Monel	Hastelloy C	Inconel 625	Titanium	Bronze	304 Stainless Steel	Duplex	Buna N (Nitrile)	EPDM/EPR	Viton	Flexible Graphite	Delrin	Peek	PVDF	Teflon and Reinforced Teflon	PCTFE	UHMWPE	Vespele	PFA	KEL-F
Resins & Rosins	-	A	A	A	A	A	A	A	A	A	A	A	A	A	A	B	A	A	A	A	A	A	A	A	A	A	A	A
Resorcinol	C ₆ H ₆ O ₂	A	B	C	C	A	A	A	A	A	A	A	A	A	A	D	B	B	A	B	A	A	A	A	A	A	A	A
Road Tar	C ₂ H ₄ O ₃	A	A	A	A	A	A	A	A	A	A	A	A	A	A	B	A	A	A	A	A	A	A	A	A	A	A	A
Roof Pitch	-	A	A	B	B	A	A	A	A	A	A	A	A	A	A	C	A	A	A	A	A	A	A	A	A	A	A	A
Rosin Emulsion	C ₁₅ H ₂₀ O ₆	A	A	A	A	A	A	A	A	A	A	A	A	A	A	D	A	A	A	A	A	A	A	A	A	A	A	A
RP-1 Fuel	-	B	B	C	C	B	A	A	A	A	A	A	A	A	A	A	B	A	A	A	A	A	A	A	A	A	A	A
Rubber Latex Emulsions	-	C	C	D	D	A	B	C	A	A	A	A	A	A	A	A	B	A	A	A	A	A	A	A	A	A	A	B
Rubber solvents	-	B	B	C	C	B	A	A	A	A	A	A	A	A	A	A	A	A	A	A	A	A	A	A	A	A	A	A
Salad Oil	-	B	B	D	D	B	B	B	B	A	A	A	A	A	A	A	A	A	A	A	A	A	A	A	A	A	A	A
Salicylic Acid	C ₇ H ₆ O ₃																											
Salt (NaCl)	NaCl+H ₂ O	B	D	C	D	B	B	B	A	A	A	A	A	A	A	A	A	A	A	A	A	A	A	A	A	A	A	A
Salt Brine	NaCl	C	C	C	D	B	A	B	A	A	A	A	A	A	A	B	A	B	A	B	A	A	A	A	A	A	A	A
Sauerkraut Brine	-	A	B	A	A	B	A	A	A	A	A	A	A	A	A	A	A	A	A	A	A	A	A	A	A	A	A	A
Sea Water	-	B	B			B	B	B	A	A	A	A	A	A	A	B	A	A	A	A	A	A	A	A	A	A	A	A
Sewage	-	D	D			C	C	A	B	A	A	A	A	A	A	D	B	B	A	D	A	A	A	A	A	A	A	A
Shellac	-	D	D	D	D	B	B	B	A	A	A	A	A	A	A	B	B	B	A	D	A	A	A	A	A	A	A	A
Silicone Fluids	Si	D	D	D	D	A	B	A	D	A	A	A	A	A	A	B	A	A	A	A	A	A	A	A	A	A	A	A
Silver Bromide	AgBr	B				A	A	A	A	A	A	A	A	A	A	A	A	A	A	A	A	A	A	A	A	A	A	A
Silver Cyanide	CAGN	C	B	B	B	A	A	A	A	A	A	A	A	A	A	A	A	A	A	A	A	A	A	A	A	A	A	A
Silver Nitrate	CAGN	B	B	C	C	B	A	B	A	B	A	B	A	B	A	B	A	A	A	A	A	A	A	A	A	A	A	A
Silver Plating sol.	-	D	B	B	C	A	A	A	A	A	A	A	A	A	A	A	A	A	A	A	A	A	A	A	A	A	A	A
Soap Solutions (Stearates)	C ₂₁ H ₄₂ O ₄	B				B	B	A	A	A	A	A	A	A	A	B	A	A	A	A	A	A	A	A	A	A	A	A
Sodium Acetate	C ₂ H ₄ O ₂	C	B	C	C	B	A	A	A	A	A	A	A	A	A	A	A	A	A	A	A	A	A	A	A	A	A	A
Sodium Aluminate	AlNaO ₂	B				A	A	A	A	A	A	A	A	A	A	D	B	A	A	A	A	A	A	A	A	A	A	A
Sodium Benzoate	C ₇ H ₆ O ₂	D	D	D	D	A	A	A	B	B	C	A	A	A	A	A	A	A	A	A	A	A	A	A	A	A	A	A
Sodium Bicarbonate	CHNaO ₃	C	B	D	D	A	B	C	B	A	A	A	A	A	A	A	A	A	A	A	A	A	A	A	A	A	A	A
Sodium Bichromate	Cr ₂ Na ₂ O ₇	C	B	C	C	B	A	A	A	A	A	A	A	A	A	A	A	A	A	A	A	A	A	A	A	A	A	A
Sodium Bisulfate 10%	H ₂ NaO ₄ S	D	B	C	D	B	B	B	B	A	B	C	A	A	A	A	A	A	A	A	A	A	A	A	A	A	A	B
Sodium Bisulfite 10%	HNaO ₃ S	D	B	D	D	A	A	A	A	A	A	A	A	A	A	A	A	A	A	A	A	A	A	A	A	A	A	A
Sodium Borate	C ₁₅ H ₂₀ O ₂	B	B	C	C	B	B	B	B	A	A	A	A	A	A	A	A	A	A	A	A	A	A	A	A	A	A	A
Sodium Bromide 10%	BrNa	B	B	C	D	B	B	B	B	A	A	A	A	A	A	A	A	A	A	A	A	A	A	A	A	A	A	A

Ratings: A - Excellent B - Good C - Poor D - Do not use Blank - No information

Media	Chemical Formula	Metals												Elastomers						Polymers							
		Aluminum	Brass	Carbon Steel	Ductile Iron / Cast Iron	316/316Ti/321 SS	17-4PH	Alloy 20	Monel	Hastelloy C	Inconel 625	Titanium	Bronze	304 Stainless Steel	Duplex	Buna N (Nitrile)	EPDM/EPR	Viton	Flexible Graphite	Delrin	Peek	PVDF	Teflon and Reinforced Teflon	PCTFE	UHMWPE	Vespe	PFA
Sodium Carbonate (Soda Ash)	Na ₂ CO ₃	D	B	B	B	B	A	A	B	A	A	B	A	A	A	A	A	A	A	A	A	A	A	A	A	A	A
Sodium Chlorate	ClNaO ₃	C	B	B	C	B	A	B	C	B	A	B	A	A	A	A	A	A	A	A	A	A	A	A	A	A	A
Sodium Chloride	ClNa	B	C	B	C	B	B	B	B	A	A	B	B	A	A	A	A	A	A	B	A	A	A	A	A	A	A
Sodium Chromate	CrNa ₂ O ₄	B	C	B	B	A	A	A	A	B	B	B	B	A	A	A	A	A	B	D	A	A	A	A	A	A	A
Sodium Citrate	C ₆ H ₅ Na ₃ O ₇	D				A	B	A	A																		
Sodium Cyanide	CNNa	D	D	B	B	A	A	B	A	A	B	A	A	A	A	A	A	A	A	A	A	A	A	A	A	A	A
Sodium Ferricyanide	CaFeNa ₃	B			C	B	B	A	B	B		C	B														
Sodium Fluoride	FNa	B	C	D	D	B	B	A	B	A	A	A	B	D													
Sodium Hydroxide 20% (cold)	NaOH	D	C	A	A	A	A	A	A	A	A	A	A	B													A
Sodium Hydroxide 20% (hot)	NaOH	D	C	B	B	A	A	B	B	A	A	A	A	B													A
Sodium Hydroxide 50% (cold)	NaOH	D	D	A	B	A	A	A	B	A	A	A	A	D													B
Sodium Hydroxide 50% (hot)	NaOH	D	D	B	B	A	A	B	B	A	A	A	A	D													B
Sodium Hydroxide 70% (cold)	NaOH	D	D	C	B	A	A	B	B	A	A	A	A	D													A
Sodium Hydroxide 70% (hot)	NaOH	D	D	C	B	A	A	B	B	A	A	A	A	D													A
Sodium Hypochlorite (Bleach)	ClNaO	D	D	D	D	D	D	D	D	A	C	D	D	D													A
Sodium Hyposulfite	Na ₂ S ₂ O ₄	B				B	B	B	B	B																	A
Sodium Lactate	C ₃ H ₅ NaO ₃	D				A	A	B	A	B																	
Sodium Metaphosphate	Na ₆ O ₁₈ P ₆	C	D	C	B	B	A	A	B	A	B	A	A	B													A
Sodium Metasilicate (cold)	Na ₂ O ₃ Si	D	B	B	C	A	A	A	A	A	A	A	A	A													A
Sodium Metasilicate (hot)	Na ₂ O ₃ Si	D	B	C	D	A	A	A	A	A																	A
Sodium Nitrate	NNaO ₃	B	B	B	B	A	A	B	B	A	A	B	B	A													A
Sodium Nitrite	NNaO ₂	A	B	B	B	A	A	A	B	B																	A
Sodium Perborate	BNaO ₃	C	D	B	C	C	A	A	A	A	A	B	B	A													A
Sodium Peroxide	Na ₂ O ₂	C	C	C	D	B	A	A	A	A	B	D	A	A													A
Sodium Phosphate (mono)	NaH ₂ PO ₄	D	C	B	D	B	A	A	B	A	A	C	B	A													A
Sodium Phosphate Di-basic	Na ₂ HPO ₄	D	C	C	C	B	A	B	B	A	A	C	A	A													A
Sodium Phosphate Tri-basic	Na ₃ PO ₄	D	C	C	C	B	A	B	B	A	A	C	A	A													A
Sodium Polyphosphate	Na ₆ O ₁₈ P ₆	D	D			D	B	B	B	A	A	C	B	A													A
Sodium Salicylate	C ₇ H ₅ NaO ₃					A	A	A																			A
Sodium Silicate	Na ₂ O ₃ Si	B	C	B	B	A	A	A	A	A	A	A	A	A													A
Sodium Silicate (hot)	Na ₂ O ₃ Si	C	D	C	C	B	B	B	B	B	B	D	A	A													A

Ratings: A - Excellent B - Good C - Poor D - Do not use Blank - No information

10.29 Chemical Compatibility Table

Media	Chemical Formula	Metals												Elastomers					Polymers									
		Aluminum	Brass	Carbon Steel	Ductile Iron / Cast Iron	316/316Ti/321 SS	17-4PH	Alloy 20	Monel	Hastelloy C	Inconel 625	Titanium	Bronze	304 Stainless Steel	Duplex	Buna N (Nitrile)	EPDM/EPR	Viton	Flexible Graphite	Delrin	Peek	PVDF	Teflon and Reinforced Teflon	PCTFE	UHMWPE	Vespe	PFA	KEL-F
Sodium Sulfate	Na ₂ O ₄ S	A	B	B	B	A	A	A	A	A	A	A	A	A	A	A	A	A	A	A	A	A	A	A	A	A	A	A
Sodium Sulfide	HNaS	D	D	C	B	A	A	A	A	B	B	B	B	B	B	B	B	B	B	B	B	B	A	A	A	A	B	B
Sodium Sulfite	NaO ₃ S	C	C	B	A	A	A	A	C	A	A	A	A	A	A	A	A	A	A	A	A	A	A	A	A	A	A	A
Sodium Tetraborate	C ₁₅ H ₂₂ O ₂	C	D	A	A	A	A	A	B	B	B	B	B	B	B	B	B	B	B	B	B	B	B	B	B	B	B	B
Sodium Thiosulfate	Na ₂ S ₂ O ₃	A	D	C	C	B	A	A	B	B	B	B	B	B	B	B	B	B	B	B	B	B	B	B	B	B	B	B
Soybean Oil	-	B	B	C	C	A	A	A	A	A	A	A	A	A	A	A	A	A	A	A	A	A	A	A	A	A	A	A
Starch	C ₂₇ H ₄₈ O ₂₀	B	B	B	B	A	A	A	A	A	A	A	A	A	A	A	A	A	A	A	A	A	A	A	A	A	A	A
Steam (212°F)	-	B	B	A	A	A	A	A	A	A	A	A	A	A	A	A	A	A	A	A	A	A	A	A	A	A	A	A
Stearic Acid	C ₁₈ H ₃₆ O ₂	B	C	C	C	B	A	A	A	A	A	A	A	A	A	A	A	A	A	A	A	A	A	A	A	A	A	A
Styrene	C ₈ H ₈	A	A	B	B	A	A	A	A	A	A	A	A	A	A	A	A	A	A	A	A	A	A	A	A	A	A	A
Sugar Liquids	-	A	A	B	B	C	A	A	A	A	A	A	A	A	A	A	A	A	A	A	A	A	A	A	A	A	A	A
Sugar, Syrups & Jam	-	B	B	B	C	A	A	A	A	A	A	A	A	A	A	A	A	A	A	A	A	A	A	A	A	A	A	A
Sulfate Black Liquor	H ₂ O ₄ S	D	C	C	C	B	A	B	B	B	B	B	B	B	B	B	B	B	B	B	B	B	B	B	B	B	B	B
Sulfate Green Liquor	H ₂ O ₄ S	D	C	C	C	B	A	B	B	B	B	B	B	B	B	B	B	B	B	B	B	B	B	B	B	B	B	B
Sulfate White Liquor	H ₂ O ₄ S	D	C	C	C	B	B	B	B	B	B	B	B	B	B	B	B	B	B	B	B	B	B	B	B	B	B	B
Sulfur	S	C	C	C	C	B	A	A	B	A	A	A	A	A	A	A	A	A	A	A	A	A	A	A	A	A	A	A
Sulfur Chloride	SCl	D	D	D	D	D	C	D	B	D	C	D	D	D	D	D	D	D	D	D	D	D	D	D	D	D	D	D
Sulfur Dioxide (dry)	SO ₂	B	B	B	B	A	A	B	B	A	A	B	C	A	A	B	A	A	A	A	A	A	A	A	A	A	A	A
Sulfur Dioxide (wet)	SO ₂	B	D	A	A	B	C	B	A	A	A	D	D	D	D	B	B	A	A	A	A	A	A	A	A	A	A	A
Sulfur Hexafluoride	SF ₆	A	B	A	A	A	A	A	C	A	A	A	A	A	A	A	A	A	A	A	A	A	A	A	A	A	A	A
Sulfur, Molten	-	A	D	C	B	B	A	A	C	B	A	A	A	A	A	A	A	A	A	A	A	A	A	A	A	A	A	A
Sulfur Trioxide	SO ₃	A	D	B	B	B	A	A	A	A	A	A	A	A	A	A	A	A	A	A	A	A	A	A	A	A	A	A
Sulfur Trioxide (dry)	SO ₃	A	C	B	B	B	B	B	B	B	B	B	B	B	B	B	B	B	B	B	B	B	B	B	B	B	B	B
Sulfuric Acid 0 to 77%	H ₂ SO ₄	D	D	D	D	C	C	B	C	A	C	D	D	D	D	D	D	D	D	D	D	D	D	D	D	D	D	D
Sulfuric Acid 100%	H ₂ SO ₄	D	D	C	C	C	C	B	C	B	C	D	D	D	D	D	D	D	D	D	D	D	D	D	D	D	D	D
Sulfurous Acid	H ₂ O ₃ S	C	D	D	D	B	B	B	B	B	B	A	D	B	C	C	A	A	A	A	A	A	A	A	A	A	A	A
Tall Oil	-	C	B	B	B	A	A	A	A	A	A	A	B	A	B	D	A	A	A	A	A	A	A	A	A	A	A	A
Tannic Acid (Tannin)	C ₂₇ H ₂₄ O ₁₈	C	B	C	C	B	B	B	B	B	B	B	B	B	B	B	B	B	B	B	B	B	B	B	B	B	B	B
Tanning Liquors	C ₂₇ H ₂₄ O ₁₈	A	A	A	A	A	A	A	A	A	A	A	A	A	A	A	A	A	A	A	A	A	A	A	A	A	A	A
Tar & Tar Oils	C ₂ H ₄ O ₃	B	A	A	A	A	A	A	A	A	A	A	A	A	A	A	A	A	A	A	A	A	A	A	A	A	A	A
Tartaric Acid	C ₄ H ₆ O ₆	B	D	D	D	A	A	A	A	A	A	B	C	A	A	B	A	A	A	A	A	A	A	A	A	A	A	A

Ratings: A - Excellent B - Good C - Poor D - Do not use Blank - No information

10.31 Basic Rubber Compounds

ELASTOMER RUBBER COMPOUNDS TYPES AND REFERENCES					
General Description	Chemical Description	Abbreviation (ASTM 1418)	ISO/DIN 1629	Other Trade names & Abbreviations	ASTM D2000 Designations
Nitrile	Acrylonitrile-butadiene rubber	NBR	NBR	Buna-N	BF, BG, BK, CH
Hydrogenated Nitrile	Hydrogenated Acrylonitrile-butadiene rubber	HNBR	(HNBR)	HNBR	DH
Ethylene-Propylene	Ethylene propylene diene rubber	EPDM	EPDM	EP, EPT, EPR	BA, CA, DA
Fluorocarbon (Viton®)	Fluorocarbon Rubber	FKM	FPM	Viton®, Fluorel®	HK
Chloroprene	Chloroprene rubber	CR	CR	Neoprene	BC, BE
Silicone	Silicone rubber	VMQ	VMQ	PVMQ	FC, FE, GE
Fluorosilicone	Fluorosilicone rubber	FVMQ	FVMQ	FVMQ	FK
Polyacrylate	Polyacrylate rubber	ACM	ACM	ACM	EH
Ethylene Acrylic	Ethylene Acrylic rubber	AEM	AEM	Vamac®	EE, EF, EG, EA
Styrene-butadiene	Styrene-butadiene rubber	SBR	SBR	SBR	AA, BA
Polyurethane	Polyester urethane / Polyether urethane	AU / EU	AU / EU	AU / EU	BG
Natural rubber	Natural rubber	NR	NR	NR	AA

Basic Property	NBR	HNBR	EPDM	FKM	CR	ACM	AEM	SBR	AU/EU	VMQ	FVMQ	NR
Economy of Material	A	D	B	C	B	C	D	A	C	C	D	A
Compression Set Resistance	A	A	A	A	B	D	B	B	C	B	B	A
Resilienc (Rebound)	B	B	B	B	B	C	B	B	B	B	B	A
Tear Strength	B	A	B	B	B	C	B	C	B	D	C	A
Heat Aging Resistance	C	B	B	A	C	A	A	C	A	A	A	C
Ozone Resistance	D	B	B	A	B	B	A	D	A	A	A	D
Resistance to Oil & Grease	B	B	D	A	B	A	C	D	B	C	A	D
Fuel Resistance	D	C	D	B	D	A	D	D	C	D	B	D
Water Swell Resistance	B	B	A	B	C	D	B	A	D	A	A	A
Gas Impermeability	B	B	C	B	B	C	B	C	B	D	D	C
Abrasion Resistance	B	B	B	C	B	B	B	A	A	D	D	A
High Temperature - Standard	100°C	148°C	148°C	198°C	121°C	148°C	148°C	100°C	80°C	232°C	205°C	105°C
Low Temperature - Standard	-30°C	-30°C	-51°C	-15°C	-40°C	-51°C	-40°C	-45°C	-51°C	-60°C	-60°C	-51°C

Ratings: A - Excellent B - Good C - Poor D - Do not use

10.32 | Hose Orientation

ORIENTATION OF FITTINGS

Proper positioning of elbow end fittings on a hose is governed by the offset angle, or the amount of angular offset between connecting parts in the installation. If this angle of orientation is not correct in the construction of a hose assembly the performance and life of the assembly will be greatly reduced.

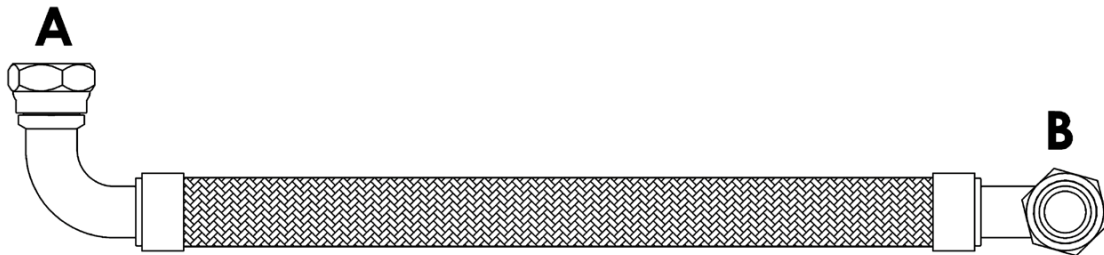

HOW TO MEASURE

Orientation is determined by the number of degrees measured in a clockwise direction. To measure the orientation angle look along the hose with the furthest fitting (**A**) away from the viewer and the nearest fitting (**B**) closest to the viewer.

Fitting (**A**) must be set at 0 Degrees.

If no angle is given elbows are positioned at 0 Degrees.

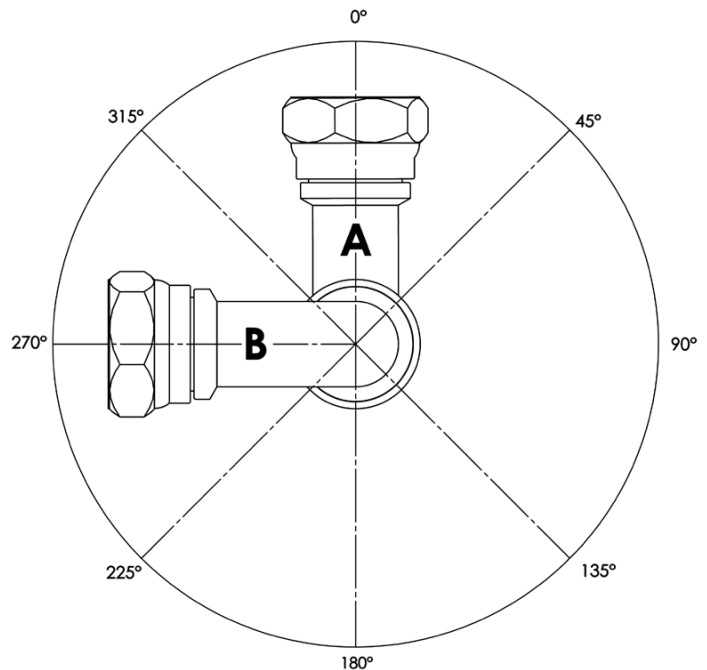

10.33 Pressure Conversions

psi	kPa	Bar	kg/cm ²	mm Hg.	cm Hg.	METRES H ₂ O	Millibar (mb)
200	1379	13.8	14	10372.8	1037.6	140.8	13789.4
400	2758	27.6	28	20745.6	2075.2	281.6	27578.8
600	4137	41.4	42	31118.4	3112.8	422.4	41368.2
800	5516	55.2	56	41491.2	4150.4	563.2	55157.6
1000	6895	69	70	51864	5188	704	68947
1200	8274	82.8	84	62236.8	6225.6	844.8	82736.4
1400	9653	96.6	98	72609.6	7263.2	985.6	96525.8
1600	11032	110.4	112	82982.4	8300.8	1126.4	110315.2
1800	12411	124.2	126	93355.2	9338.4	1267.2	124104.6
2000	13790	138	140	103728	10376	1408	137894
2200	15169	151.8	154	114100.8	11413.6	1548.8	151683.4
2400	16548	165.6	168	124473.6	12451.2	1689.6	165472.8
2600	17927	179.4	182	134846.4	13488.8	1830.4	179262.2
2800	19306	193.2	196	145219.2	14526.4	1971.2	193051.6
3000	20685	207	210	155592	15564	2112	206841
3200	22064	220.8	224	165964.8	16601.6	2252.8	220630.4
3400	23443	234.6	238	176337.6	17639.2	2393.6	234419.8
3600	24822	248.4	252	186710.4	18676.8	2534.4	248209.2
3800	26201	262.2	266	197083.2	19714.4	2675.2	261998.6
4000	27580	276	280	207456	20752	2816	275788
4200	28959	289.8	294	217828.8	21789.6	2956.8	289577.4
4400	30338	303.6	308	228201.6	22827.2	3097.6	303366.8
4600	31717	317.4	322	238574.4	23864.8	3238.4	317156.2
4800	33096	331.2	336	248947.2	24902.4	3379.2	330945.6
5000	34475	345	350	259320	25940	3520	344735
5200	35854	358.8	364	269692.8	26977.6	3660.8	358524.4
5400	37233	372.6	378	280065.6	28015.2	3801.6	372313.8
5600	38612	386.4	392	290438.4	29052.8	3942.4	386103.2
5800	39991	400.2	406	300811.2	30090.4	4083.2	399892.6
6000	41370	414	420	311184	31128	4224	413682
6200	42749	427.8	434	321556.8	32165.6	4364.8	427471.4
6400	44128	441.6	448	331929.6	33203.2	4505.6	441260.8
6600	45507	455.4	462	342302.4	34240.8	4646.4	455050.2
6800	46886	469.2	476	352675.2	35278.4	4787.2	468839.6
7000	48265	483	490	363048	36316	4928	482629
7200	49644	496.8	504	373420.8	37353.6	5068.8	496418.4
7400	51023	510.6	518	383793.6	38391.2	5209.6	510207.8
7600	52402	524.4	532	394166.4	39428.8	5350.4	523997.2
7800	53781	538.2	546	404539.2	40466.4	5491.2	537786.6
8000	55160	552	560	414912	41504	5632	551576
8200	56539	565.8	574	425284.8	42541.6	5772.8	565365.4
8400	57918	579.6	588	435657.6	43579.2	5913.6	579154.8
8600	59297	593.4	602	446030.4	44616.8	6054.4	592944.2
8800	60676	607.2	616	456403.2	45654.4	6195.2	606733.6
9000	62055	621	630	466776	46692	6336	620523
9200	63434	634.8	644	477148.8	47729.6	6476.8	634312.4
9400	64813	648.6	658	487521.6	48767.2	6617.6	648101.8
9600	66192	662.4	672	497894.4	49804.8	6758.4	661891.2
9800	67571	676.2	686	508267.2	50842.4	6899.2	675680.6
10000	68950	690	700	518640	51880	7040	689470
10200	70329	703.8	714	529012.8	52917.6	7180.8	703259.4



TECHNICAL DATA

10.34 | Nominal Dimensions of Tube (ASTM A269)

Nominal Tube Size	Outside Diameter	Wall Thickness	Weight
inches	mm	mm	Kg/m
3/16"	4.76	0.50	0.05
		0.70	0.07
		0.90	0.09
1/4"	6.35	0.50	0.07
		0.70	0.10
		0.90	0.12
		1.20	0.15
		1.60	0.19
5/16"	7.94	0.50	0.09
		0.70	0.13
		0.90	0.16
		1.20	0.20
		1.60	0.25
3/8"	9.52	0.50	0.11
		0.70	0.15
		0.90	0.19
		1.20	0.25
1/2"	12.70	0.50	0.15
		0.70	0.21
		0.90	0.26
		1.20	0.34
5/8"	15.88	0.50	0.19
		0.70	0.27
		0.90	0.34
		1.20	0.43
		1.60	0.56
3/4"	19.05	0.50	0.23
		0.70	0.32
		0.90	0.41
		1.20	0.53
		1.90	0.69
		2.00	0.84
		3.25	1.27
7/8"	22.22	0.90	0.48
		1.20	0.62
		1.60	0.81
1"	25.40	0.50	0.31
		0.70	0.43
		0.90	0.55
		1.20	0.72
		1.60	0.94
		2.00	1.15
		2.60	1.49
		3.20	1.78
1 1/8"	28.58	1.20	0.82
		1.60	1.08

Nominal Tube Size	Outside Diameter	Wall Thickness	Weight
inches	mm	mm	Kg/m
1 1/4"	31.75	0.90	0.69
		1.20	0.90
		1.60	1.19
		2.00	1.47
		2.60	1.89
1 3/8"	34.92	0.90	0.77
		1.20	1.01
1 1/2"	38.10	0.90	0.83
		1.20	1.09
		1.60	1.44
		2.00	1.78
		2.60	2.28
1 3/4"	44.45	0.90	0.98
		1.20	1.28
		1.60	1.69
		2.00	2.09
2"	50.80	0.90	1.12
		1.20	1.47
		1.60	1.94
		2.00	2.41
		2.60	3.09
2 1/2"	63.50	1.20	1.84
		1.60	2.44
		2.00	3.03
		2.60	3.90
3"	76.20	0.90	0.69
		1.20	0.90
		1.60	1.19
		2.00	1.47
		2.60	1.89
3 1/2"	88.90	1.20	1.84
		1.60	2.44
		2.00	3.03
		2.60	3.90
4"	101.60	1.20	1.84
		1.60	2.44
		2.00	3.03
		2.60	3.90
5"	127.0	1.60	3.44
		2.00	4.29
		2.60	5.53
		3.20	6.76
6"	152.4	1.60	3.44
		2.00	4.29
		2.60	5.53
		3.20	6.76



TECHNICAL DATA

10.35 | Nominal Dimensions of Pipe (ASTM A312M)

Nominal Pipe Size		Outside Diameter (mm)	Wall Thickness (mm)																
			Stainless Steel				Carbon Steel												
DN	NPS		Sch 5S	Sch 10S	Sch 40S	Sch 80S	Sch 10	Sch 20	Sch 30	Sch 40	STD	Sch 60	Sch 80	XS	Sch 100	Sch 120	Sch 140	Sch 160	XXS
6	1/8"	10.3	-	1.24	1.73	2.41	1.24	-	1.45	1.73	1.73	-	2.41	2.41	-	-	-	-	-
8	1/4"	13.7	-	1.65	2.24	3.02	1.65	-	1.85	2.24	2.24	-	3.02	3.02	-	-	-	-	-
10	3/8"	17.1	-	1.65	2.31	3.20	1.65	-	1.85	2.31	2.31	-	3.20	3.20	-	-	-	-	-
15	1/2"	21.3	1.65	2.11	2.77	3.73	2.11	-	2.41	2.77	2.77	-	3.73	3.73	-	-	-	4.78	7.47
20	3/4"	26.7	1.65	2.11	2.87	3.91	2.11	-	2.41	2.87	2.87	-	3.91	3.91	-	-	-	5.56	7.82
25	1"	33.4	1.65	2.77	3.38	4.55	2.77	-	2.90	3.38	3.38	-	4.55	4.55	-	-	-	6.35	9.09
32	1 1/4"	42.2	1.65	2.77	3.56	4.85	2.77	-	2.97	3.56	3.56	-	4.85	4.85	-	-	-	6.35	9.70
40	1 1/2"	48.3	1.65	2.77	3.68	5.08	2.77	-	3.18	3.68	3.65	-	5.08	5.08	-	-	-	7.14	10.15
50	2"	60.3	1.65	2.77	3.91	5.54	2.77	-	3.18	3.91	3.91	-	5.54	5.54	-	-	-	8.74	11.07
65	2 1/2"	73.0	2.11	3.05	5.16	7.01	3.05	-	4.78	5.16	5.16	-	7.01	7.01	-	-	-	9.53	14.02
80	3"	88.9	2.11	3.05	5.49	7.62	3.05	-	4.78	5.49	5.49	-	7.62	7.62	-	-	-	11.13	15.24
90	3 1/2"	101.6	2.11	3.05	5.74	8.08	3.05	-	4.78	5.74	5.74	-	8.08	8.08	-	-	-	-	-
100	4"	114.3	2.11	3.05	6.02	8.56	3.05	-	4.78	6.02	6.02	-	8.56	8.56	-	11.13	-	13.49	17.12
125	5"	141.3	2.77	3.40	6.55	9.53	3.40	-	-	6.55	6.55	-	9.53	9.53	-	12.70	-	15.88	19.05
150	6"	168.3	2.77	3.40	7.11	10.97	3.40	-	-	7.11	7.11	-	10.97	10.97	-	14.27	-	18.26	21.95
200	8"	219.1	2.77	3.76	8.18	12.70	3.76	6.35	7.04	8.18	8.18	10.31	12.70	12.70	15.09	18.26	20.62	23.01	22.23
250	10"	273.1	3.40	4.19	9.27	12.70	4.19	6.35	7.80	9.27	9.27	12.70	15.09	12.70	18.26	21.44	25.40	28.58	25.40
300	12"	323.9	3.96	4.57	9.53	12.70	4.57	6.35	8.38	10.31	9.53	14.27	17.48	12.70	21.44	25.40	28.58	33.32	25.40
350	14"	355.9	3.96	4.78	9.53	12.70	6.35	7.92	9.53	11.13	9.53	15.09	19.05	12.70	23.83	27.79	31.75	35.71	-
400	16"	406.4	4.19	4.78	9.53	12.70	6.35	7.92	9.53	12.70	9.53	16.66	21.44	12.70	26.19	30.96	36.53	40.49	-
450	18"	457	4.19	4.78	9.53	12.70	6.35	7.92	11.13	14.27	9.53	19.05	23.83	12.70	29.36	34.93	39.67	45.24	-
500	20"	508	4.78	5.54	9.53	12.70	6.35	9.53	12.70	15.09	9.53	20.62	26.19	12.70	32.54	38.10	44.45	50.01	-
550	22"	559	4.78	5.54	-	-	6.35	9.53	12.70	-	9.53	22.23	28.58	12.70	34.93	41.28	47.63	53.98	-
600	24"	610	5.54	6.35	9.53	12.70	6.35	9.53	14.27	17.48	9.53	24.61	30.96	12.70	38.89	46.02	52.37	59.54	-
650	26"	660	-	-	-	-	7.92	12.70	-	-	9.53	-	-	12.70	-	-	-	-	-
700	28"	711	-	-	-	-	7.92	12.70	15.88	-	9.53	-	-	12.70	-	-	-	-	-
750	30"	762	6.35	7.92	-	-	7.92	12.70	15.88	-	9.53	-	-	12.70	-	-	-	-	-

1 2 3 4 5 6 7 8 9

TECHNICAL DATA

10.36 Pipe Expansion Table

Coefficient	13	17.3	16	90	52	16.5
Material	Steel	Stainless Steel 304	Stainless Steel 316	ABS Thermoplastic	PVC Thermoplastic	Copper
Temp °C	mm/m	mm/m	mm/m	mm/m	mm/m	mm/m
-140	-2.12	-2.82	-2.61	-14.67	-8.48	-2.69
-120	-1.86	-2.47	-2.29	-12.87	-7.44	-2.36
-100	-1.60	-2.13	-1.97	-11.07	-6.40	-2.03
-80	-1.34	-1.78	-1.65	-9.27	-5.36	-1.70
-60	-1.08	-1.44	-1.33	-7.47	-4.32	-1.37
-50	-0.95	-1.26	-1.17	-6.57	-3.80	-1.20
-40	-0.82	-1.09	-1.01	-5.67	-3.28	-1.04
-30	-0.69	-0.92	-0.85	-4.77	-2.76	-0.87
-20	-0.56	-0.74	-0.69	-3.87	-2.24	-0.71
-15	-0.49	-0.66	-0.61	-3.42	-1.98	-0.63
-10	-0.43	-0.57	-0.53	-2.97	-1.72	-0.54
-5	-0.36	-0.48	-0.45	-2.52	-1.46	-0.46
0	-0.30	-0.40	-0.37	-2.07	-1.20	-0.38
5	-0.23	-0.31	-0.29	-1.62	-0.29	-0.30
10	-0.17	-0.22	-0.21	-1.17	-0.21	-0.21
20	-0.04	-0.05	-0.05	-0.27	-0.05	-0.05
23	0.00	0.00	0.00	0.00	0.00	0.00
30	0.09	0.12	0.11	0.63	0.36	0.12
40	0.22	0.29	0.27	1.53	0.88	0.28
50	0.35	0.47	0.43	2.43	1.40	0.45
60	0.48	0.64	0.59	3.33	1.92	0.61
70	0.61	0.81	0.75	4.23	2.44	0.78
75	0.68	0.90	0.83		2.70	0.86
80	0.74	0.99	0.91		2.96	0.94
90	0.87	1.16	1.07		3.48	1.11
100	1.00	1.33	1.23		4.00	1.27
110	1.13	1.51	1.39		4.52	1.44
120	1.26	1.68	1.55		5.04	1.60
130	1.39	1.85	1.71		5.56	1.77
140	1.52	2.02	1.87			1.93
150	1.65	2.20	2.03			2.10
160	1.78	2.37	2.19			2.26
170	1.91	2.54	2.35			2.43
180	2.04	2.72	2.51			2.59
190	2.17	2.89	2.67			2.76
200	2.30	3.06	2.83			2.92
220	2.56	3.41	3.15			3.25
240	2.82	3.75	3.47			
250	2.95	3.93	3.63			
260	3.08	4.10	3.79			
280	3.34	4.45	4.11			
290	3.47	4.62	4.27			
300	3.60	4.79	4.43			
320	3.86	5.14	4.75			
340	4.12	5.48	5.07			
360	4.38	5.83	5.39			
380	4.64	6.18	5.71			
400	4.90	6.52	6.03			
420	5.16	6.87	6.35			
440	5.42	7.21	6.67			
460	5.68	7.56	6.99			
480	5.94	7.91	7.31			
500	6.20	8.25	7.63			
520	6.46	8.60	7.95			
540	6.72	8.94	8.27			
560	6.98	9.29	8.59			
580	7.24	9.64	8.91			
600	7.50	9.98	9.23			
620	7.76	10.33	9.55			
640	8.02	10.67	9.87			
660	8.28	11.02	10.19			
680	8.54	11.37	10.51			
700	8.80	11.71	10.83			
720	9.06	12.06	11.15			
740	9.32	12.40	11.47			
760	9.58	12.75	11.79			

10.37 Stub End Type B Dimensions (ASTM A403)

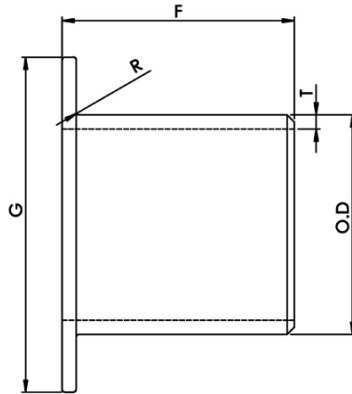

Nominal Pipe Size		Outside Diameter (O.D) (mm)	Wall Thickness (T) (mm)			Dimensions		
DN	NPS		10S	40S	80S	G	F	R
15	1/2"	21.7	2.11	2.77	3.73	35	51	0.8
20	3/4"	27.2	2.11	2.87	3.91	43	51	0.8
25	1"	34.0	2.77	3.38	4.55	51	51	0.8
32	1 1/4"	42.7	2.77	3.56	4.85	64	51	0.8
40	1 1/2"	48.6	2.77	3.68	5.08	73	51	0.8
50	2"	60.5	2.77	3.91	5.54	92	64	0.8
65	2 1/2"	76.3	3.05	5.16	7.01	105	64	0.8
80	3"	89.1	3.05	5.49	7.62	127	64	0.8
90	3 1/2"	101.6	3.05	5.74	8.08	140	76	0.8
100	4"	114.3	3.05	6.02	8.56	157	76	1.6
125	5"	139.8	3.40	6.55	9.53	186	76	1.6
150	6"	165.2	3.40	7.11	10.97	216	89	1.6
200	8"	216.3	3.76	8.18	12.70	270	102	1.6
250	10"	267.4	4.19	9.27	12.70	324	127	1.6
300	12"	318.5	4.57	9.53	12.70	381	152	1.6

10.38 90° & 45° Elbows Dimensions (ASTM A403)

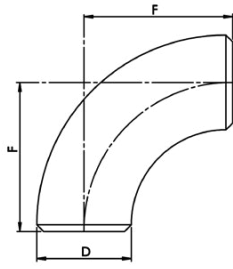

90° ELBOW

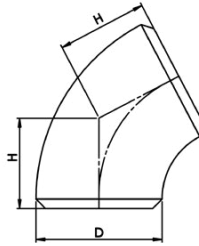

45° ELBOW

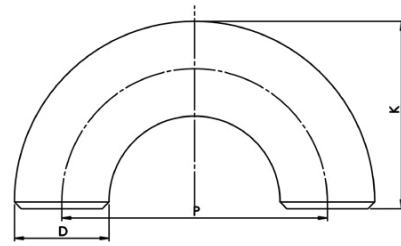

180° ELBOW

Nominal Pipe Size		Outside Diameter (mm)	Center To End		Center To Center		End To End		
			90° Elbow (F)		45° Elbow (H)	180° Elbow (P)		180° Elbow (K)	
DN	NPS		Long	Short	Long	Long	Short	Long	Short
15	1/2"	21.7	38.1	-	15.8	76.2	-	49.0	-
20	3/4"	27.2	38.1	-	15.8	76.2	-	51.7	-
25	1"	34.0	38.1	25.4	15.8	76.2	50.8	55.1	42.4
32	1 1/4"	42.7	47.6	31.8	19.7	95.2	63.6	69.0	53.2
40	1 1/2"	48.6	57.2	38.1	23.7	114.4	76.2	81.5	62.4
50	2"	60.5	76.2	50.8	31.6	152.4	101.6	106.5	81.1
65	2 1/2"	76.3	95.3	63.5	39.5	190.6	127.0	133.5	101.7
80	3"	89.1	114.3	76.2	47.3	228.6	152.4	158.9	120.8
90	3 1/2"	101.6	133.4	88.9	55.3	266.8	177.8	184.2	139.7
100	4"	114.3	152.4	101.6	63.1	304.8	203.2	209.6	158.8
125	5"	139.8	190.5	127.0	78.9	381.0	254.0	260.4	196.9
150	6"	165.2	228.6	152.4	94.7	457.2	304.8	311.2	235.0
200	8"	216.3	304.8	203.2	126.3	609.6	406.4	413.0	311.4
250	10"	267.4	381.0	254.0	157.8	762.0	508.0	514.7	387.7
300	12"	318.5	457.2	304.8	189.4	914.4	609.6	616.5	464.1
350	14"	355.6	533.4	355.6	220.9	1066.8	711.2	711.2	533.4
400	16"	406.4	609.6	406.4	252.5	1219.2	812.8	812.8	609.6
450	18"	457.2	685.8	457.2	284.1	-	-	-	-
500	20"	508.0	762.0	508.0	315.6	-	-	-	-
550	22"	558.8	838.2	558.8	347.2	-	-	-	-
600	24"	609.6	914.4	609.6	378.7	-	-	-	-
650	26"	660.4	990.6	660.4	410.3	-	-	-	-
700	28"	711.2	1066.8	711.2	441.9	-	-	-	-
750	30"	762.0	1143.0	762.0	473.4	-	-	-	-

10.39 Concentric / Eccentric Reducers (ASTM A403)

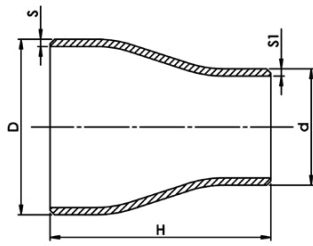

Concentric Reducer

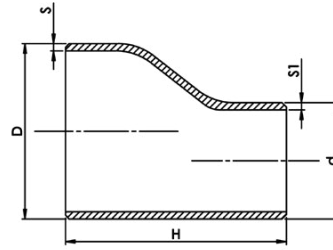

Eccentric Reducer

NPS	D	d	H	Wall Thickness				Weights (kg)	
				SCH STD		SCH XS		SCH STD	SCH XS
				S	S1	S	S1		
3/4" x 1/2"	26.7	21.3	38	2.87	2.77	3.91	3.73	0.10	0.15
1" x 3/4"	33.4	26.7	51	3.38	2.87	4.55	3.91	0.14	0.17
1 x 1/2"		21.3		3.38	2.77	4.55	3.73	0.14	0.16
1 1/4" x 1"	42.2	33.4	51	3.56	3.38	4.85	4.55	0.20	0.24
1 1/4" x 3/4"		26.7		3.56	2.87	4.85	3.91	0.20	0.23
1 1/4" x 1/2"		21.3		3.56	2.77	4.85	3.73	0.19	0.22
1 1/2" x 1 1/4"	48.3	42.2	64	3.68	3.56	5.08	4.85	0.26	0.33
1 1/2" x 1"		33.4		3.68	3.38	5.08	4.55	0.24	0.31
1 1/2" x 3/4"		26.7		3.68	2.87	5.08	3.91	0.22	0.27
1 1/2" x 1/2"		21.3		3.68	2.77	5.08	3.73	0.20	0.26
2" x 1 1/2"	60.3	48.3	76	3.91	3.68	5.54	5.08	0.41	0.54
2" x 1 1/4"		42.4		3.91	3.56	5.54	4.85	0.39	0.53
2" x 1"		33.4		3.91	3.38	5.54	4.55	0.37	0.48
2" x 3/4"		26.7		3.91	2.87	5.54	3.91	0.33	0.46
2" x 1/2"		21.3		3.91	2.77	5.54	3.73	0.31	0.42
2 1/2" x 2"	73	60.3	89	5.16	3.91	7.01	5.54	0.73	0.94
2 1/2" x 1 1/2"		48.3		5.16	3.68	7.01	5.08	0.68	0.86
2 1/2" x 1 1/4"		42.2		5.16	3.56	7.01	4.85	0.67	0.79
2 1/2" x 1"		33.4		5.16	3.38	7.01	4.55	0.59	0.79
3" x 2 1/2"	88.9	73	89	5.49	5.16	7.62	7.01	0.98	1.29
3" x 2"		60.3		5.49	3.91	7.62	5.54	0.91	1.18
3" x 1 1/2"		48.3		5.49	3.68	7.62	5.08	0.86	1.04
3" x 1 1/4"		42.2		5.49	3.56	7.62	4.85	0.77	1.04
3" x 1"		33.4		5.49	3.38	7.62	4.55	0.73	1.04
3 1/2" x 3"	101.6	88.9	102	5.74	5.49	8.08	7.62	1.38	1.85
3 1/2" x 2 1/2"		73		5.74	5.16	8.08	7.01	1.34	1.75
3 1/2" x 2"		60.3		5.74	3.91	8.08	5.54	1.23	1.61
3 1/2" x 1 1/2"		48.3		5.74	3.68	8.08	5.08	1.14	1.43
3 1/2" x 1 1/4"		42.2		5.74	3.56	8.08	4.85	1.14	1.43
4" x 3 1/2"	114.3	101.6	102	6.02	5.74	8.56	8.08	1.64	2.21
4" x 3"		88.9		6.02	5.49	8.56	7.62	1.59	2.13
4" x 2 1/2"		73		6.02	5.16	8.56	7.01	1.52	2.01
4" x 2"		60.3		6.02	3.91	8.56	5.54	1.44	1.78
4" x 1 1/2"		48.3		6.02	3.68	8.56	5.08	1.24	1.73
4" x 1 1/4"		42.2		6.02	3.56	8.56	4.85	1.20	1.71
4" x 1"		33.4		6.02	3.38	8.56	4.55	1.12	1.70
5" x 4"	141.3	114.3	127	6.55	6.02	9.52	8.56	2.72	3.78
5" x 3 1/2"		101.6		6.55	5.74	9.52	8.08	2.65	3.65

10.40 | Rolled Groove Couplings Dimensions - Fig 10

Specifications

Grooved piping system is reliable and faster to install than welding, threading or flanging. This results in the lowest possible installed cost. It can be adapted to suit standard pipe with cut grooves or standard and light wall pipe with rolled grooves.

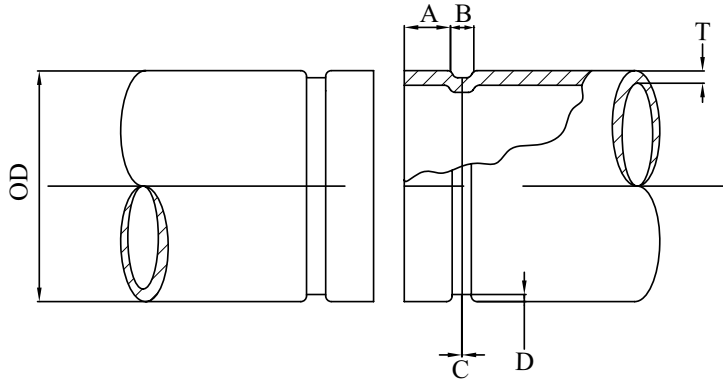

Standard Roll Groove Specifications												
Nominal Pipe Size	Pipe Outside Diameter (mm) 'OD'			Gasket seat $\pm 0.30 \pm .770$ (mm) 'A'	Groove width $\pm 0.30 \pm .770$ (mm) 'B'	Groove Diameter 'C'		Groove Depth	STD C/S Min allow wall thickness (mm) 'T'	Sch 10s S/S Min allow wall thickness (mm) 'T'	Sch 40s S/S Min allow wall thickness (mm) 'T'	Max Flare Diameter (mm)
	Actual	Tolerance (+)	Tolerance (-)			mm	mm					
1"	33.70	+0.381	-0.381	15.875	7.137	30.226	-0.381	1.600	3.38	2.77	3.38	34.5
1 1/4"	42.40	+0.381	-0.381	15.875	7.137	38.989	-0.381	1.600	3.56	2.77	3.56	43.3
1 1/2"	48.30	+0.381	-0.381	15.875	7.137	45.085	-0.381	1.600	3.65	2.77	3.68	49.4
2"	60.30	+0.610	-0.610	15.875	8.738	57.150	-0.381	1.600	3.91	2.77	3.91	62.2
*2 1/2"	73.00	+0.737	-0.737	15.875	8.738	69.088	-0.457	1.981	5.16	3.05	5.16	75.2
2 1/2"	76.10	+0.737	-0.737	15.875	8.738	69.088	-0.457	1.981	5.16	3.05	5.16	75.2
3"	88.90	+0.889	-0.737	15.875	8.738	84.938	-0.457	1.981	5.49	3.05	5.49	90.3
4"	114.30	+1.143	-0.737	15.875	8.738	110.084	-0.508	2.108	6.02	3.05	6.02	116.2
5"	141.30	+1.422	-0.737	15.875	8.738	137.033	-0.559	2.134	6.55	3.40	6.55	143.5
6"	165.10	+1.600	-0.737	15.875	8.738	163.957	-0.559	2.159	7.11	3.40	7.11	170.7
*6"	168.30	+1.600	-0.737	15.875	8.738	163.957	-0.559	2.159	7.11	3.40	7.11	170.7
8"	219.10	+1.600	-0.737	19.050	11.913	214.401	-0.635	2.337	8.18	3.76	8.18	221.5
10"	273.00	+1.600	-0.737	19.050	11.913	268.28	-0.687	2.387	9.27	4.19	9.27	277.4
12"	323.90	+1.600	-0.737	19.050	11.913	318.29	-0.758	2.697	10.31	4.57	9.53	328.2

* USA pipe size

Specifications		
PRODUCT	WORKING PRESSURE	MAX WORKING TEMP
RIGID COUPLING	300 PSI / 2068 kPa	100°C
90° ELBOW		
45° ELBOW		
EQUAL TEE		
REDUCING TEE		
CONCENTRIC REDUCER		
CAP		
MECHANICAL TEE	1600 kPa	

*Refer to Fittings, Flanges & Couplings Section for part numbers - Page 226 - 227

10.41 | Triclover Ferrule Dimensions

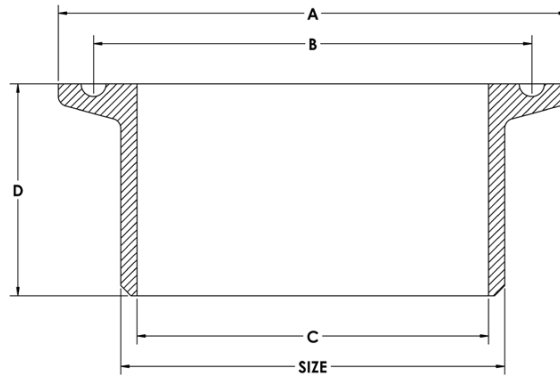

Size		A	B	C	D
DN	(mm)				
1/2"	12.7	25.1	20.0	9.5	21
3/4"	19.1	25.1	20.0	15.9	21
1"	25.4	50.5	43.5	22.2	21
1 1/4"	31.8	50.5	43.5	28.6	21
1 1/2"	38.1	50.5	43.5	34.9	21
2"	50.8	64.0	56.5	47.6	21
2 1/2"	63.5	77.5	70.5	60.3	21
3"	76.2	91.0	83.5	73	21
4"	101.6	119.0	110.0	98.4	21
6"	152.4	166.1	157.0	148.4	27
8"	203.2	217.5	207.2	199.2	29
10"	254	268.5	-	250	29
12"	304.8	319.5	308.8	300.8	29

*Refer to Fittings, Flanges & Couplings Section for part numbers - Page 244

10.43 Bolt Hole Sequence

To obtain a leak-free flange connection, a proper gasket installation is needed, the bolts must be assigned on the correct bolt tension, and the total bolt strength must be evenly divided over the whole flange face.

With Torque Tightening (the application of preload to a fastener by the turning of the fastener's nut) the correct bolt tension can be realized.

Correct tightening of a bolt means making the best use of the bolt's elastic properties. To work well, a bolt must behave just like a spring. In operation, the tightening process exerts an axial pre-load tension on the bolt. This tension load is of course equal and opposite to the compression force applied on the assembled components. It can be referred to as the "tightening load" or "tension load".

4 and 8 Bolt Flanges

- First round - 30% of final torque (flange sequential order)
- Second round - 60% of final torque (flange sequential order)
- Third round - 100% of final torque (flange sequential order)
- One final time - clockwise or counter clockwise sequentially around the flange

12 Bolt Flanges and More

- First round - 20% of final torque (flange sequential order)
- Second round - 40% of final torque (flange sequential order)
- Third round - 80% of final torque (flange sequential order)
- Fourth round - 100% of final torque (sequential order)
- One final time - clockwise or counter clockwise sequentially around the flange



The selection of the proper flange bolt tightening technique requires experience. The successful application of any technique also requires qualification of both the tools that will be used and the crew who will do the work. The following summarizes the most commonly used flange bolt tightening techniques.

- Manual Wrench
- Impact Wrench
- Hammer Wrench
- Hydraulic Torque Wrench
- Manual Beam and Gear-Assisted Torque Wrench
- Hydraulic Bolt Tensioner

Tightening Sequence

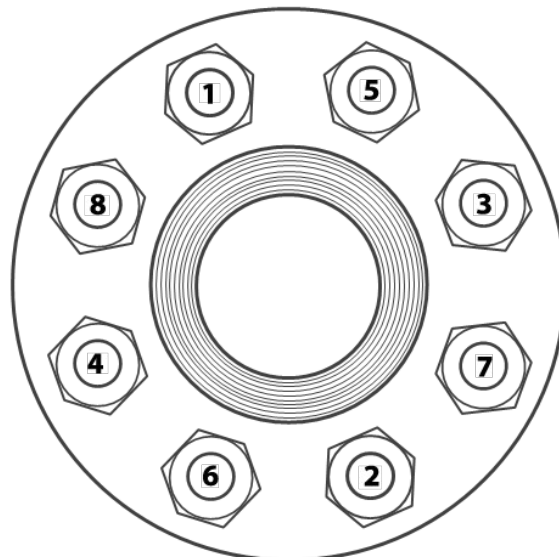

WELD SYMBOLS

COMMONLY USED IN AUSTRALIA

BASIC GAS AND ARC WELDING SYMBOLS	
	FILLET
	BEAD
	GENERAL BUTT
	SQUARE BUTT
	SINGLE BEVEL BUTT
	SINGLE VEE BUTT
	SINGLE 'U' BUTT
	SINGLE 'J' BUTT
	PLUG OR SLOT
	STUD
	SURFACING

RESIISTANCE WELDING SYMBOLS	
	SPOT
	SEAM
	MASH SEAM
	STICH
	MASH STICH
	PROJECTION
	FLASH BUTT
	RESISTANCE BUTT

SUPPLEMENTARY WELDING SYMBOLS	
	WELD ALL ROUND
	FLUSH CONTOUR
	WELD ON SITE
	BACKING STRIP OR BAR
	FLUSH SURFACE FINISH
	CONVEX SURFACE FINISH
	CONCAVE SURFACE FINISH
	BACKING WELD RUN
	TAIL, FOR NOTES

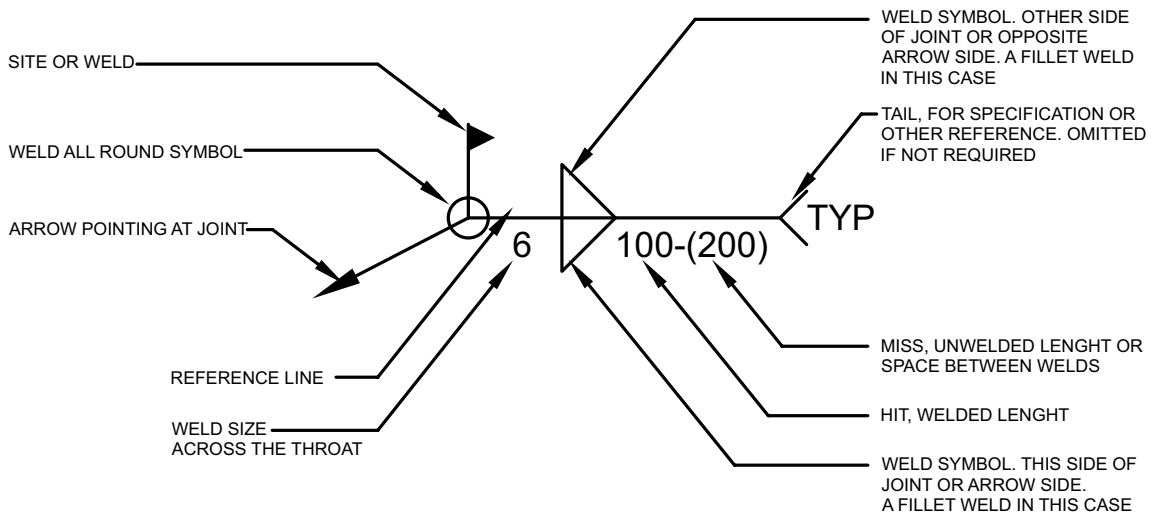

10.45 Thread Specification - BSPT & BSPP (BS21)

BSPT male threads seal against threads of fixed BSPT female. Contact is made on the flanks of the threads.

Use of a thread sealant is recommended for BSPT male to BSPT female connections.

Measure the BSPT male thread OD and female thread ID at the first full thread near the end of the fitting.

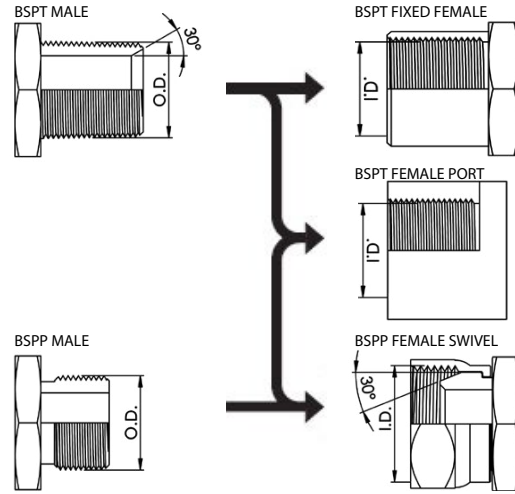

BSPT male and BSPP male with conical 30° seat (60° included angle) seal against matching conical 30° seat of BSPP female swivel.



BSPP O Ring male connector has straight threads and O Ring with metal Retaining Ring. It seals against flat external surface of BSPP female port.

BSPP male, with chamfer to locate Bonded Seal also seals against flat external surface of BSPP female port. Surface irregularities require a Spot Face to ensure effective sealing. Elbows and tees have Lock Nut to allow orientation of fitting to required direction.

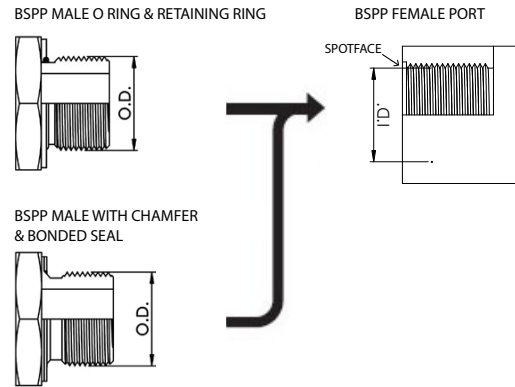

BSPP male and BSPP female flat face swivel require a suitable soft washer between faces to seal. For low working pressure.

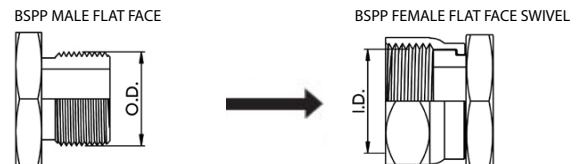

BSPT & BSPP SIZE & PITCH	DASH SIZE	BSPT MALE THREAD O.D.		BSPP MALE THREAD O.D.		BSPT FEMALE THREAD I.D.		BSPP FEMALE THREAD I.D.	
		mm	inch	mm	inch	mm	inch	mm	inch
1/8 - 28	-02	9.5	0.37	9.6	0.38	8.4	0.33	8.6	0.34
1/4 - 19	-04	12.8	0.50	13.0	0.51	11.2	0.44	11.9	0.47
3/8 - 19	-06	16.3	0.64	16.5	0.65	14,7	0.59	15.2	0.60
1/2 - 14	-08	20.4	0.80	20.8	0.82	18,3	0.72	19.1	0.75
5/8 - 14	-10	22.5	0.89	22.8	0.90	20,6	0.81	20.8	0.82
3/4 - 14	-12	25.9	1.02	26.3	1.04	23,9	0.94	24.6	0.97
1 - 11	-16	32.6	1.28	33.1	1.30	29,7	1.17	30.7	1.21
1 1/4 - 11	-20	41.1	1.62	41.8	1.64	38,6	1.52	39.4	1.55
1 1/2 - 11	-24	47.0	1.85	47.7	1.88	44,5	1.75	45.5	1.79
2 - 11	-32	58.6	2.31	59.5	2.34	56,4	2.22	57.4	2.26
2 1/2 - 11	-40	74.1	2.92	75.1	2.95	71,9	2.83	72.6	2.86
3 - 11	-48	86.6	3.41	87.9	3.46	84,6	3.33	85.4	3.36

10.46 | Thread Specification - NPT & NPSM (ANSI B1.20.1)

National Pipe threads are similar in function to BSP threads, but are not generally interchangeable. NPTF threads (also known as Dryseal) are an improvement to NPT.

Controlled truncation of threads mean the metal-to-metal thread seal is at root and crest of threads, in addition to flanks of threads.

Use of thread sealant is recommended for NPT male and NPT female connection.

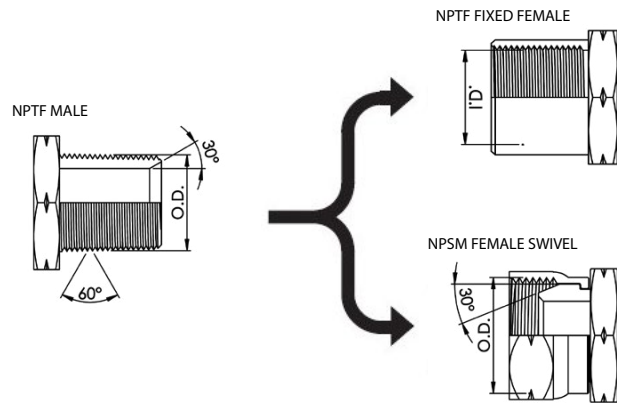

Measure NPT male thread OD and NPT female thread ID at first full thread near end of fitting.

NPT Threads Dimensions

NPT THREAD SIZE & PITCH	DASH SIZE	MALE THREAD MINOR O.D.		FEMALE THREAD I.D.	
		mm	inch	mm	inch
1/8 - 27	-02	9.9	0.39	8.4	0.33
1/4 - 18	-04	13.2	0.52	11.2	0.44
3/8 - 18	-06	16.6	0.65	14.7	0.58
1/2 - 14	-08	20.6	0.81	17.8	0.70
3/4 - 14	-12	26.0	1.02	23.4	0.92
1 - 11 1/2	-16	32.5	1.28	29.5	1.16
1 1/4 - 11 1/2	-20	41.2	1.62	38.1	1.50
1 1/2 - 11 1/2	-24	47.3	1.86	43.9	1.73
2 - 11 1/2	-32	59.3	2.33	56.4	2.22
2 1/2 - 8	-40	71.5	2.82	69.1	2.72
3 - 8	-48	87.3	3.44	84.8	3.34

NPSM Threads Dimensions

NPT THREAD SIZE & PITCH	DASH SIZE	FEMALE THREAD I.D.	
		mm	inch
1/8 - 27	-02	8.6	0.34
1/4 - 18	-04	11.9	0.47
3/8 - 18	-06	15.0	0.59
1/2 - 14	-08	19.1	0.75
3/4 - 14	-12	24.6	0.97
1 - 11 1/2	-16	30.5	1.20
1 1/4 - 11 1/2	-20	39.4	1.55
1 1/2 - 11 1/2	-24	45.5	1.79
2 - 11 1/2	-32	57.4	2.26
2 1/2 - 8	-40	68.8	2.71
3 - 8	-48	84.6	3.33

1. JIS Tapered Pipe Thread

The Japanese tapered pipe thread connector is identical to and interchangeable with the BSPT (tapered) connector. The Japanese male thread does not have a 30° Flare, and will not mate with the BSPP female swivel with conical seat. The seal on the Japanese tapered pipe thread connector is made on the threads. Use of a thread sealant is recommended.

Thread form per JIS B 0203 (identical to BSPT, Refer to BSPT section for dimensions of threads.)

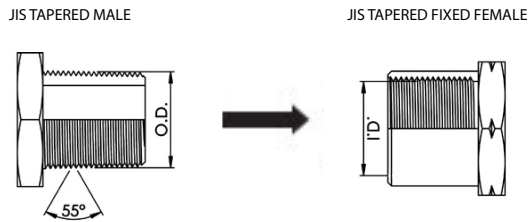

2. JIS 30° Flare (Female Internal Cone Seat)

This connection uses a 60° concave (inverted) seat and British Standard Pipe Parallel threads. They are not interchangeable with BSPP conical seat couplings, because the cone seats are opposite.

Thread form per JIS B 0203 (identical to BSPT, Refer to BSPT section for dimensions of threads.)

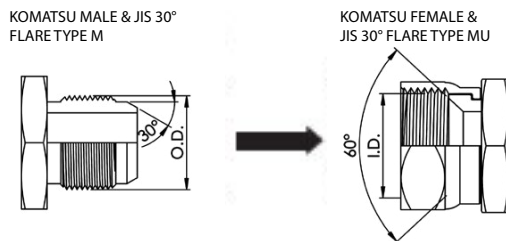

3. Komatsu 30° flare (Female Internal Cone Seat)

Threads commonly used on Komatsu equipment (30° cone) have metric thread form.

MALE THREAD O.D. & PITCH	DASH SIZE	FEMALE THREAD I.D.
M14 x 1.5	-1415	12.5
M18 x 1.5	-1815	16.5
M22 x 1.5	-2215	20.5
M24 x 1.5	-2415	22.5
M30 x 1.5	-3015	28.5
M33 x 1.5	-3315	31.5
M36 x 1.5	-3615	34.5
M33 x 1.5	-3315	31.5

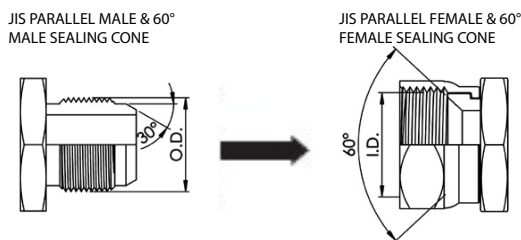

4. Komatsu Style Flange Fitting JIS B 8363

The Komatsu style Flange fitting is nearly identical to, and fully interchangeable with, the SAE Code 61 flange fitting*. The O Ring dimensions are different between all sizes. When replacing a Komatsu style flange with an SAE style flange, an SAE style O Ring must always be used. *5/8" is not in the SAE Standards.

10.48 | Thread Specification - JIC 37° FLARE & UNO (SAE J514)

JIC male has 37° flare which seals against 37° seat in female. JIC male can also seal against 37° flared tubing with JIC nut and sleeve.

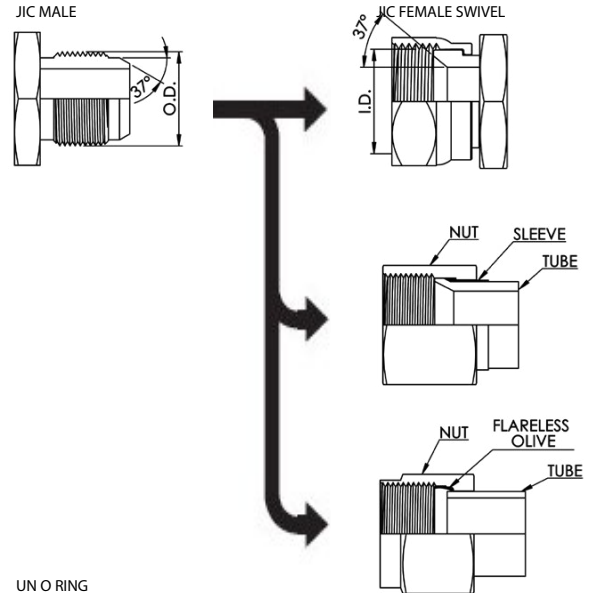

JIC male can also be used with RYCO S134 J-Lok Female Nut and Flareless Olive on Imperial OD tubing.

UNO (O Ring Boss) seals with ORing compressed between hex boss of UN male and 12°/15° tapered bore of UN (O Ring Boss) female port. For elbows and tees, Backup Washer and Lock Nut allow orientation of fitting to required direction.

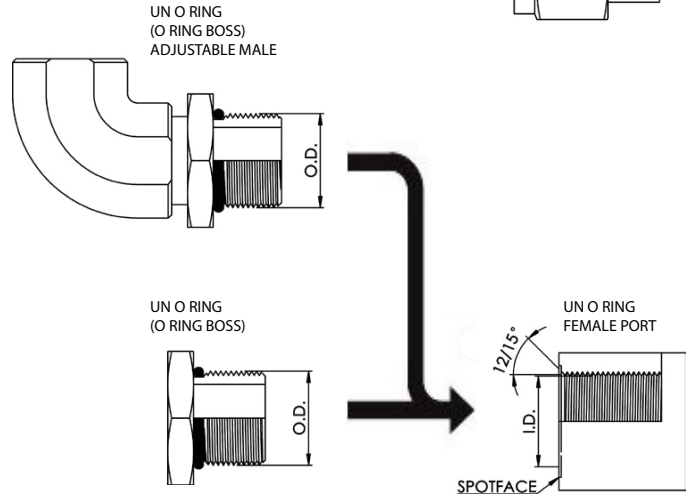

MALE THREAD O.D. & PITCH	DASH SIZE	MALE THREAD O.D.		FEMALE THREAD O.D.		TUBE SIZE
		mm	inch	mm	inch	
inch - TPI		mm	inch	mm	inch	inch
5/16 - 24 UNF	-05	7.9	0.31	6.9	0.27	1/8
3/8 - 24 UNF	-06	9.5	0.38	8.5	0.33	3/16
7/16 - 20 UNF	-07	11.1	0.44	9.9	0.39	1/4
1/2 - 20 UNF	-08	12.7	0.50	11.4	0.45	5/16
9/16 - 18 UNF	-09	14.3	0.56	13.0	0.51	3/8
3/4 - 16 UNF	-12	19.1	0.75	17.5	0.69	1/2
7/8 - 14 UNF	-14	22.2	0.88	20.3	0.80	5/8
1 1/16 - 12 UN	-17	27.0	1.06	24.9	0.98	3/4
1 3/16 - 12 UN	-19	30.2	1.19	28.2	1.11	7/8
1 5/16 - 12 UN	-21	33.3	1.31	31.2	1.23	1
1 5/8 - 12 UN	-26	41.3	1.63	39.1	1.54	1 1/4
1 7/8 - 12 UN	-30	47.6	1.88	45.5	1.79	1 1/2
2 1/2 - 12 UN	-40	63.5	2.50	61.5	2.42	2

10.49 Thread Specification - Metric DIN (DIN 3852-1)

The same male used with a metal Bonded Seal will mate with a DIN 3852-1 metric threaded port with spotface.

The DIN male 24° internal cone seat will seal with flareless female swivel fittings. These female fittings use either a spherical nose (DKL/DKS) or an O Ring seal (DKOL/DKOS) located on their outward facing 24° cone. Female DKL sizes up to and including M26 have a universal 24°/60° cone and can be used in place of female DKM fittings with 60° cone.

BSPP O Ring male connector has straight threads and O Ring with metal Retaining Ring. It seals against flat external surface of BSPP female port.

BSPP male, with chamfer to locate Bonded Seal also seals against flat external surface of BSPP female port.

Surface irregularities require a Spot Face to ensure effective sealing. Elbows and tees have Lock Nut to allow orientation of fitting to required direction.

The same male also mates with the DIN system Metric Tube, Tube Nut and Compression Olive (Cutting Ring). Tightening of the female nut compresses the olive causing it to cut into the tube, thereby forming a seal between the tube, olive and 24° male cone.

The same male used with a metal Bonded Seal will mate with a DIN 3852-1 metric threaded port with spotface.

DKM 60° CONE SEAT

The DIN male 60° internal cone seat will mate with DKL/DKM female universal 24°/60° cone fittings up to and including size M26 and DKM female 60° cone fittings from size M30 up.

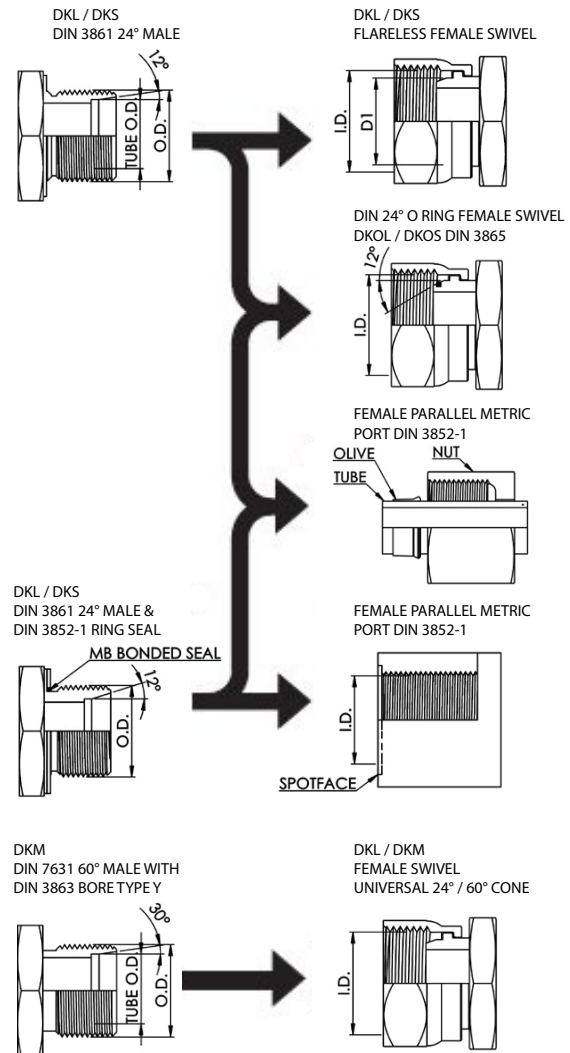

MALE THREAD O.D. & PITCH	FEMALE THREAD I.D.	* LIGHT SERIES - DKL/DKOL				HEAVY SERIES - DKS/DKOS			
		DASH SIZE	TUBE O.D.	D1 DIA	D2 DIA	DASH SIZE	TUBE O.D.	D1 DIA	D2 DIA
mm	mm		mm	mm	mm		mm	mm	mm
M12 x 1.5	10.5	-1215*	6	7.5	6.3	-	-	-	-
M14 x 1.5	12.5	-1415*	8	9.5	8.2	-1415	6	7.5	6.3
M16 x 1.5	14.5	-1615*	10	11.5	10.2	-1615	8	9.5	7.9
M18 x 1.5	16.5	-1815*	12	14.0	12.2	-1815	10	12.0	10.0
M20 x 1.5	18.5	-	-	-	-	-2015	12	14.0	12.0
M22 x 1.5	20.5	-2215*	15	17.0	15.2	-2215	14	16.0	14.2
M24 x 1.5	22.5	-	-	-	-	-2415	16	18.0	15.8
M26 x 1.5	24.5	-2615*	18	20.0	18.2	-	-	-	-
M30 x 2.0	28.0	-3020	22	24.5	22.2	-3020	20	22.5	19.8
M36 x 2.0	34.0	-3620	28	30.5	28.2	-3620	25	27.5	24.5
M42 x 2.0	40.0	-	-	-	-	-4220	30	33.0	30.0
M45 x 2.0	43.0	-4520	35	38.0	35.4	-	-	-	-
M52 x 2.0	50.0	-5220	42	45.0	42.4	-5220	38	41.0	36.8

10.50 Thread Specification - SAE (SAE J512)

SAE 45° FLARE- SAE J512

SAE male has 45° flare which seals against 45° seats in females. Males can also seal against 45° flared tubing with nut and sleeve.

7/16 - 20, 1/2 - 20, 3/4 - 16 & 7/8 - 14 are the same thread form as JIC 37° flare. Some fittings in these sizes have both JIC 37° & SAE 45° seats.

MALE THREAD O.D. & PITCH	DASH SIZE	MALE THREAD O.D.		FEMALE THREAD I.D.		TUBE SIZE
		mm	inch	mm	inch	
inch - TPI		mm	inch	mm	inch	inch
5/16 - 24	-05	7.9	0.31	6.8	0.27	1/8
3/8 - 24	-06	9.5	0.38	8.4	0.33	3/16
7/16 - 20	-07	11.1	0.44	9.9	0.39	1/4
1/2 - 20	-08	12.7	0.50	11.4	0.44	5/16
5/8 - 18	-10	15.9	0.63	14.2	0.56	3/8
3/4 - 16	-12	19.1	0.75	17.5	0.69	1/2
7/8 - 14	-14	22.2	0.88	20.6	0.81	5/8
1 1/16 - 14	-17	27.0	1.06	24.9	0.98	3/4

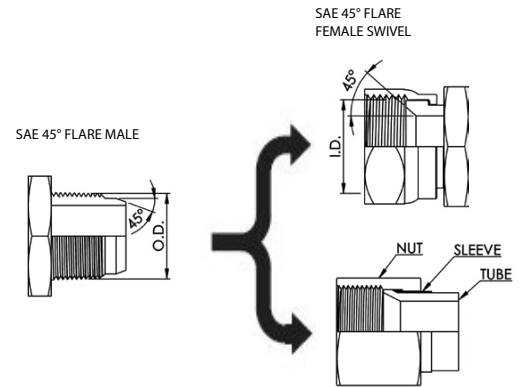

SAE 45° INVERTED FLARE - SAE J512

MALE THREAD O.D. & PITCH	DASH SIZE	MALE THREAD O.D.		FEMALE THREAD I.D.		TUBE SIZE
		mm	inch	mm	inch	
inch - TPI		mm	inch	mm	inch	inch
7/16 - 24	-07	11.1	0.44	9.9	0.39	1/4
1/2 - 20	-08	12.7	0.50	11.4	0.45	5/16
5/8 - 18	-10	15.9	0.63	14.2	0.56	3/8
1 1/16 - 18	-11	17.5	0.69	16.0	0.63	7/16

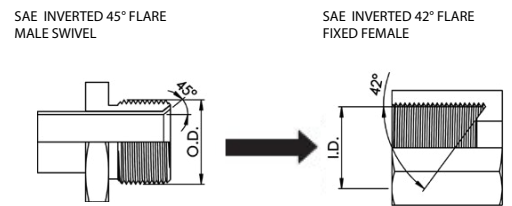

SAE PILOT O RING SEALS

Pilot Male Swivel

MALE THREAD O.D. & PITCH	DASH SIZE	MALE THREAD O.D.		FEMALE THREAD I.D.		TUBE SIZE
		mm	inch	mm	inch	
inch - TPI		mm	inch	mm	inch	inch
5/8 - 18	-10	15.9	0.63	14.2	0.56	-6
3/4 - 18	-12	19.0	0.75	17.8	0.70	-8
7/8 - 18	-14	22.2	0.88	20.6	0.81	-10

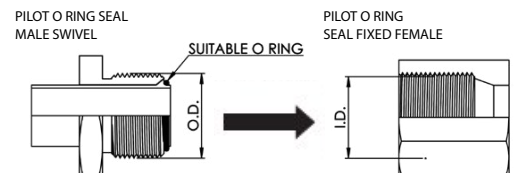

Pilot Female Swivel

MALE THREAD O.D. & PITCH	DASH SIZE	MALE THREAD O.D.		FEMALE THREAD I.D.		TUBE SIZE
		mm	inch	mm	inch	
inch - TPI		mm	inch	mm	inch	inch
5/8 - 18	-10	15.9	0.63	14.2	0.56	-6
3/4 - 16	-12	19.0	0.75	17.5	0.69	-8
3/4 - 16	-12	19.0	0.75	17.5	0.69	-8

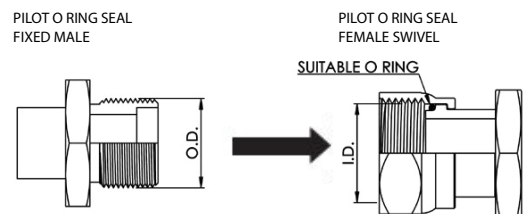

10.51 | Thread Specification - Metric French GAZ

Also known as Metric French GAZ 24°

These seal on a 24° cone seat located internally on the male connector using straight fine metric threads.

Metric French GAZ series uses fractional number metric OD tubing, as shown in the table.

Metric French Millimetric series uses whole number metric OD tubing. The two series are not interconnectable.

The male will mate with a straight thread female swivel with spherical nose seat.

The same male also mates with flareless tube, Tube Nut and Compression Olive (Cutting Ring). Tightening of the female nut compresses the olive causing it to cut into the tube, thereby forming a seal between the tube, olive and 24° male cone.

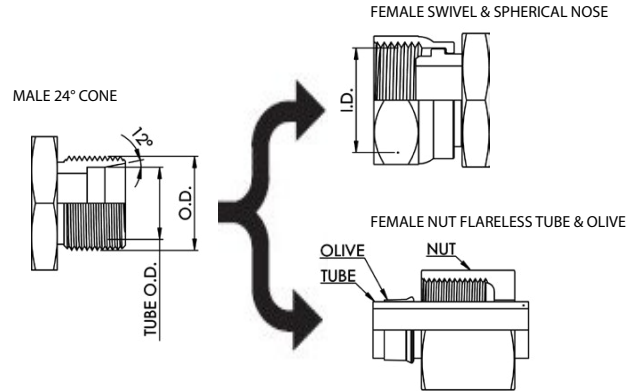

MALE THREAD O.D. & PITCH	DASH SIZE	MALE THREAD O.D.		FEMALE THREAD I.D.		TUBE SIZE
		mm	inch	mm	inch	
inch - TPI						mm
M20 x 1.5	-20	20.0	0.78	18.5	0.72	13.25
M24 x 1.5	-24	24.0	0.94	22.5	0.88	16.75
M30 x 1.5	-30	30.0	1.18	28.5	1.12	21.25
M36 x 1.5	-36	36.0	1.41	34.5	1.35	26.75
M45 x 1.5	-45	45.0	1.77	43.5	1.71	33.50
M52 x 1.5	-52	52.0	2.04	50.5	1.98	42.25

10.52 | Thread Specification - Metric French Millimetric

Also known as Metric Millimetric

These seal on a 24° cone seat located internally on the male connector using straight fine metric threads.

Metric French GAZ series uses fractional number metric OD tubing, as shown in the table.

Metric French Millimetric series uses whole number metric OD tubing. The two series are not interconnectable.

The male will mate with a straight thread female swivel with spherical nose seat.

The same male also mates with flareless tube, Tube Nut and Compression Olive (Cutting Ring). Tightening of the female nut compresses the olive causing it cut into the tube, thereby forming a seal between the tube, olive and 24° male cone.

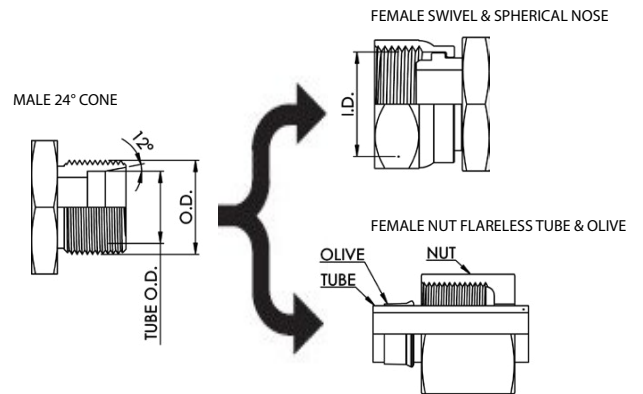

MALE THREAD O.D. & PITCH	DASH SIZE	MALE THREAD O.D.		FEMALE THREAD I.D.		TUBE SIZE
		mm	inch	mm	inch	
inch - TPI		mm	inch	mm	inch	mm
M27 x 1.5	-27	27.0	1.06	25.5	1.00	20
M30 x 1.5	-30	30.0	1.18	28.5	1.12	22
M33 x 1.5	-33	33.0	1.30	31.5	1.24	25
M36 x 1.5	-36	36.0	1.41	34.5	1.35	28
M39 x 1.5	-39	39.0	1.54	37.5	1.48	30
M45 x 1.5	-45	45.0	1.77	43.5	1.71	35

10.53 | Thread Specification - ORFS (SAE J1453)

SAE J1453, ISO 8434-3
ORFS is O RING FACE SEAL

ORFS system consists of ORFS Male with O Ring in Face, which seals against Flat Seated ORFS Female Swivel Nut fitting.

The Swivel Nut can be slipped back to help installation in tight situations.

The prominent position of the O Ring on the Male fitting makes it easy to inspect the condition of the O Ring.

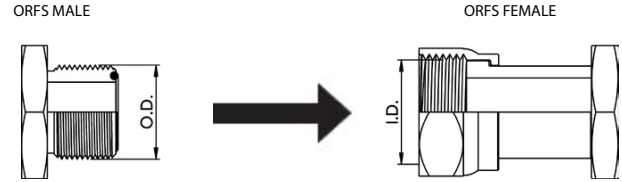

MALE THREAD O.D. & PITCH	DASH SIZE	MALE THREAD O.D.		FEMALE THREAD I.D.		TUBE SIZE
		mm	inch	mm	inch	
9/16 - 18 UNF	-09	14.3	0.56	12.9	0.51	1/4
11/16 - 16 UN	-11	17.3	0.68	16.0	0.63	3/8
13/16 - 16 UN	-13	20.6	0.81	19.1	0.75	1/2
1 - 14 UNS	-16	25.4	1.00	23.6	0.73	5/8
1.3/16 - 12 UN	-19	30.0	1.18	28.2	1.11	3/4
1.7/16 - 12 UN	-23	36.3	1.43	34.3	1.35	1
1.11/16 - 12 UN	-27	42.7	1.68	40.6	1.60	1.1/4
2 - 12 UN	-32	51.8	2.00	48.8	1.92	1.1/2

10.54 | Nomograph

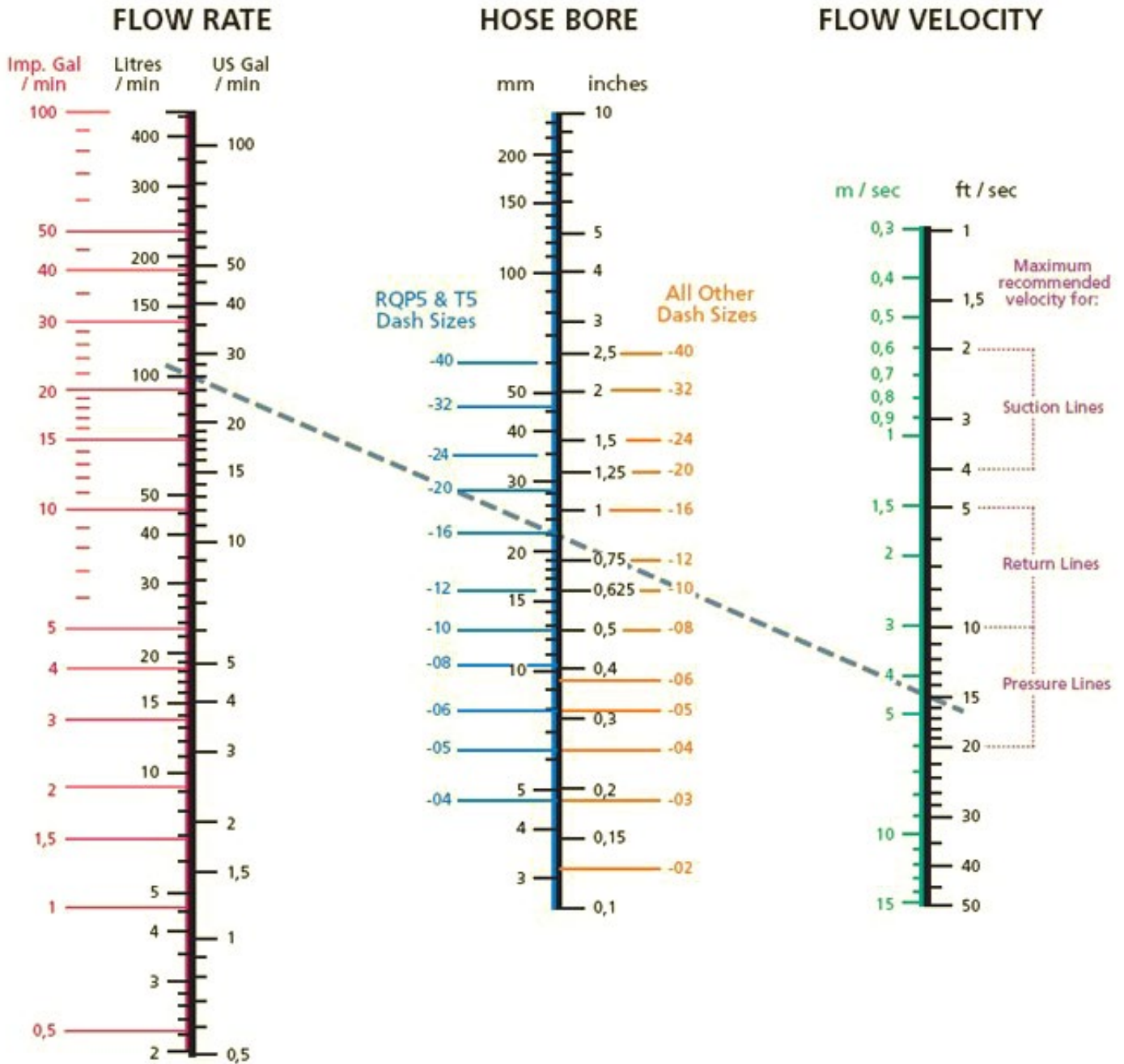

1. Pick the two known values.
2. Lay a straightedge to intersect the two values.
3. Intersection on the third vertical line gives the value of that factor.

Example:

To find the bore size for a Pressure Line consistent with a Flow Rate of 100 litres per minute (26 US or 22 Imperial gallons per minute), and a Flow Velocity of 4.5 metres per second (14.8 feet per second), connect Flow Rate to Flow Velocity and read Hose Bore on centre scale.

Answer:

The line crosses Hose Bore between -12 and -16 on "All Other Dash Sizes" side of Hose Bore axis, so a -16 hose is required. If RQP5 or T5 Hose is to be used, for this example -16 would also be required.

Based On Formula:

$$\text{Area (SQ. IN.)} = \frac{0.321 \times \text{FLOW (G.P.M.)}}{\text{VELOCITY (FT./SEC)}}$$

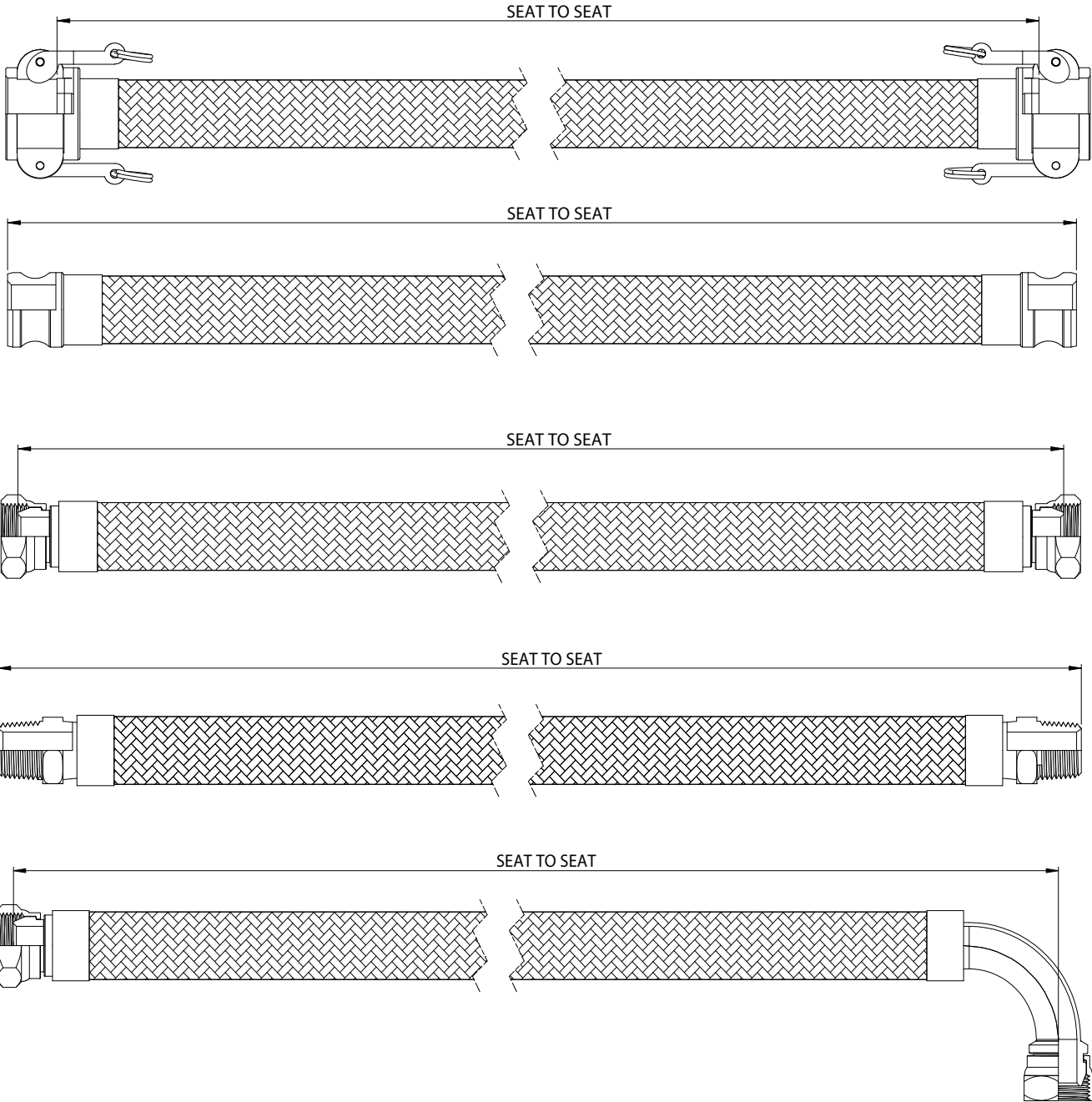

10.56 | Hose Measurements

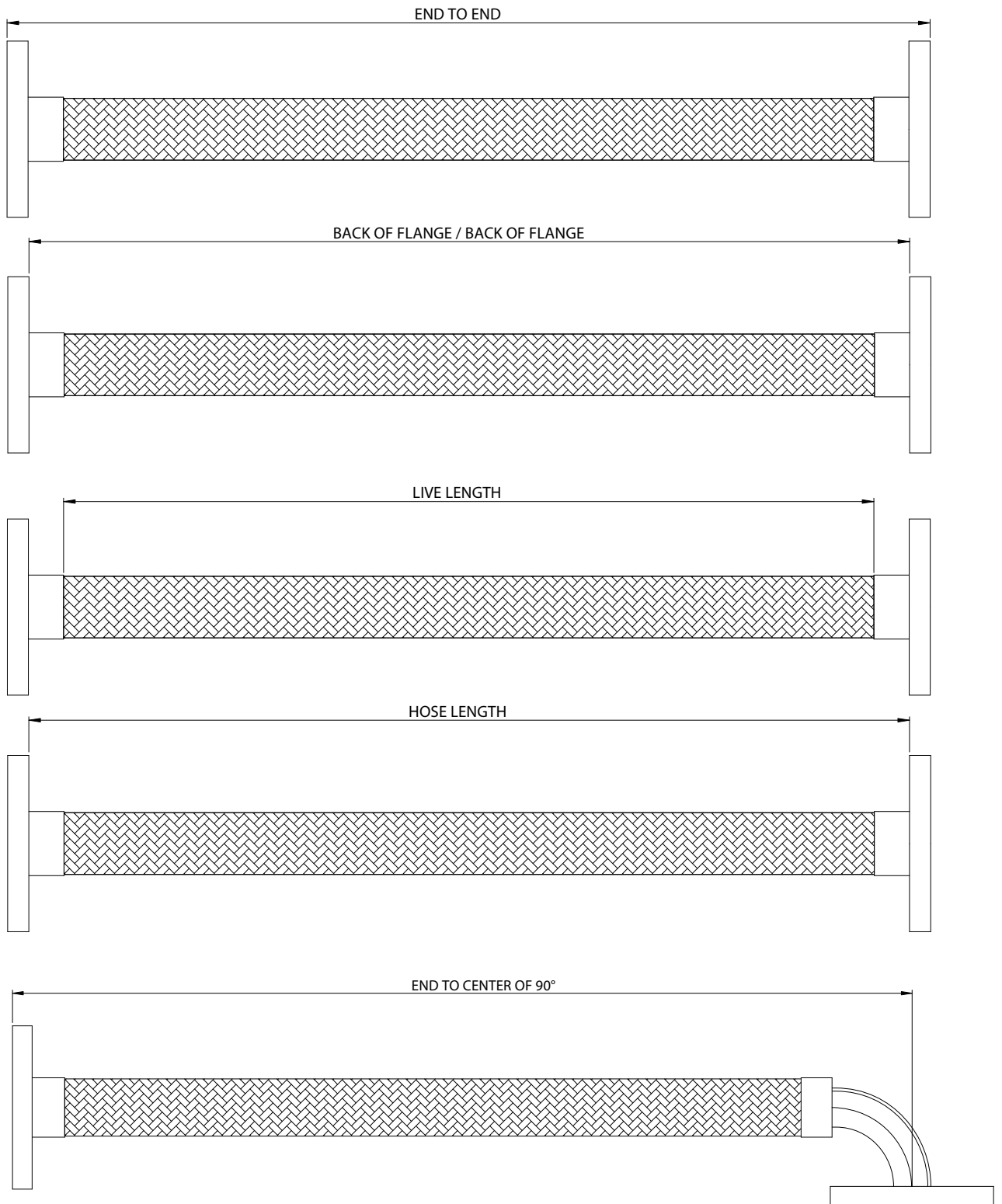

10.57 | Hose Measurements

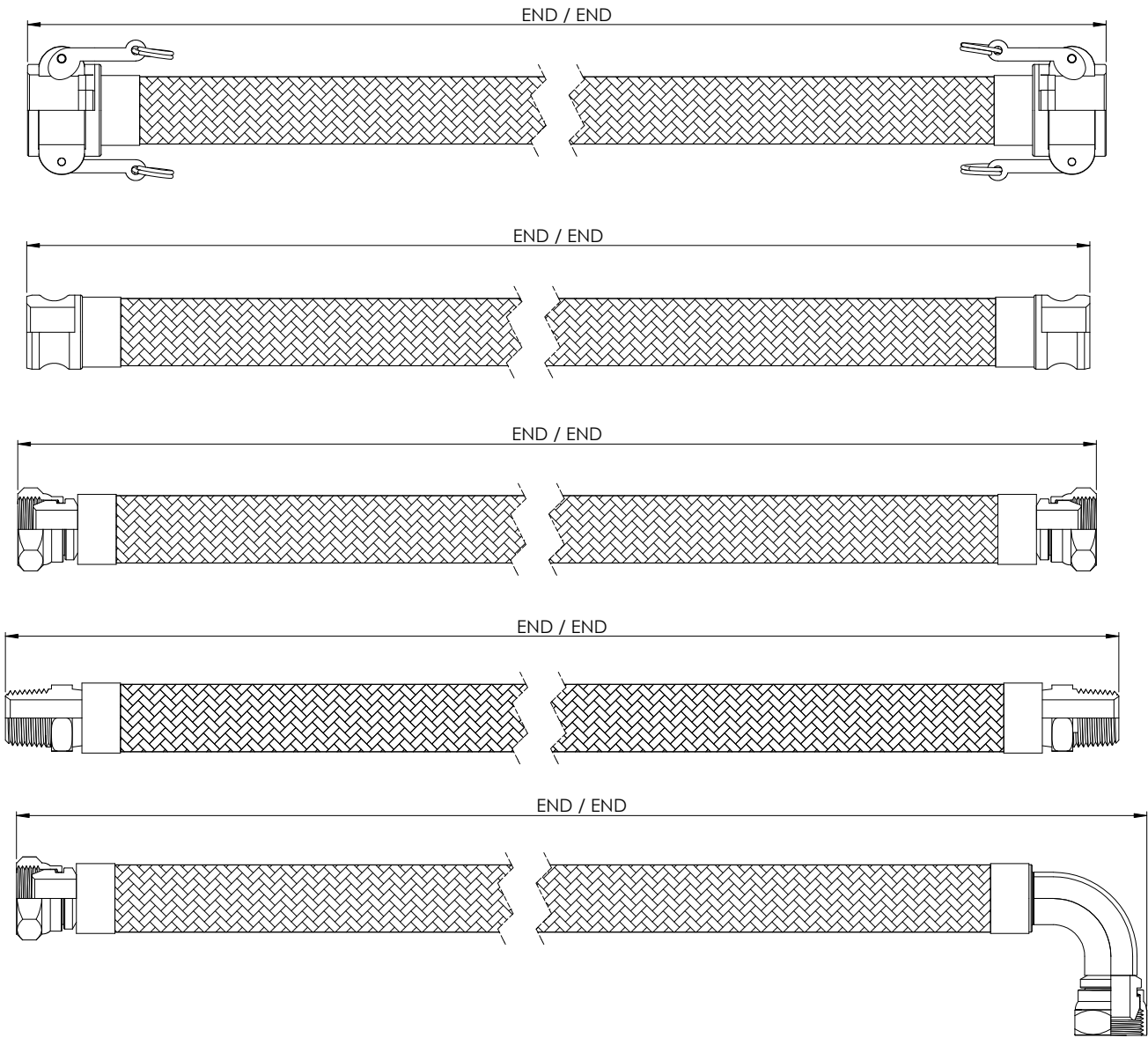

OUR FLEXIBILITY YOUR SOLUTION

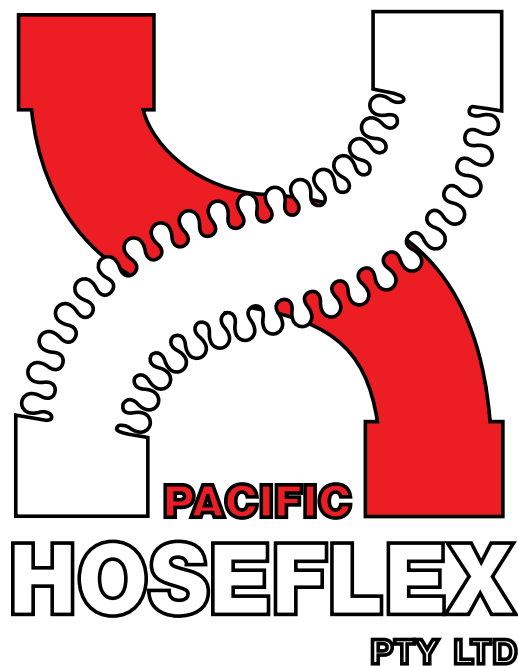

Queensland Branch / Head Office

10 Alex Fisher Drive, Burleigh Heads QLD 4220

Phone: +617 5593 4292

Web Address: www.hoseflex.com

Email: salesqld@hoseflex.com.au

Perth Branch:

U1, 431 Yangebup Rd, Cockburn Central WA 6164

Phone: +618 9468 2840

Web Address: www.hoseflex.com

Email: saleswa@hoseflex.com.au

Victoria Branch:

47 Technology Drive, Sunshine West, VIC 3020

Phone: +613 8566 7250

Web Address: www.hoseflex.com

Email: salesvic@hoseflex.com.au